

MAGNAMED

Operations Manual

Electronic Pulmonary Ventilator

FlexiMag Max 700

Fleximag Max 500

Fleximag Max 300

The total or partial reproduction of this work by any form or means, whether electronic or mechanical, including reprographic processes, is prohibited without the express authorization of the company.

(Law No. 9.610/1.998)

This operating manual includes the 3 models of pulmonary ventilators of FlexiMag Max's family: Fleximag Max 700, Fleximag Max 500 and Fleximag Max 300 developed and manufactured by Magnamed Tecnologia Medica S / A.

Review of this operation manual: 06

ANVISA Registration nº 80659160005

All rights reserved by:

Magnamed Tecnologia Médica S/A



Santa Monica Street, 801, 831

06715-865 – Parque Industrial San José -Cotia – SP Brazil

Tel/Fax: +55 11 4615-8500

E-mail: magnamed@magnamed.com.br

Website: www.magnamed.com.br

CNPJ: 01.298.443/0002-54

State registration: 149.579.528.111

Technical Responsible: Toru Miyagi Kinjo

Inscription CREA-SP: 5061555031

Legal Responsible: Wataru Ueda

Table of Contents

1 SAFETY NOTES	14
1.1 DEFINITIONS	14
1.2 WARNING.....	15
1.3 ATTENTION	18
1.4 OBSERVATION	18
2 FEATURES	19
2.1 INTENDED USE.....	19
2.2 PRINCIPLE OF OPERATION	19
2.3 GENERAL FEATURES	21
2.4 TECHNICAL CHARACTERISTICS	22
2.5 SAFETY FEATURES	23
3 UNPACKING THE PRODUCT	24
3.1 INITIAL VERIFICATIONS	24
3.2 LIST OF COMPONENTS.....	24
3.3 OPTIONAL PARTS AND ACCESSORIES	26
4 IDENTIFICATION OF COMPONENTS	28
4.1 FRONT VIEW	28
4.1.4 <i>Front panel</i>	29
4.2 BACK VIEW.....	30
4.3 VIEW FROM THE BOTTOM OF THE DISPLAY	30
5 PREPARATION FOR USE	31
5.1 ASSEMBLY	31
5.2 ELECTRICAL NETWORK CONNECTION.....	41
5.3 VERIFICATION BEFORE USE	42
5.4 SHUTDOWN PROCEDURE	44
6 INSTRUCTIONS FOR USE	45

6.1 INITIAL SEQUENCE	45
6.2 RESTRICTED MENU	48
6.2.1 Patient.....	48
6.2.2 Autotest.....	48
6.2.3 Calibration.....	48
6.2.4 Status	49
6.2.5 Battery	49
6.2.6 System.....	49
6.2.7 Advanced.....	49
6.2.8 Ventilation.....	49
6.3 MAIN SCREEN.....	50
6.3.1 Battery status area	50
6.3.2 Patient information area.....	50
6.3.2.1 Volume x weight patient definition.....	50
6.3.3 Historical events area.....	51
6.3.4 Alarm setting area	51
6.3.5 Mute alarm button.....	51
6.3.6 Manual cycle button	51
6.3.7 Inspiratory hold button	52
6.3.8 Expiratory hold button	52
6.3.9 O ₂ + button (O ₂ flush)	52
6.3.10 Nebulizer / TGI button.....	52
6.3.11 Graphic freeze button	52
6.3.12 Menu access area	52
6.3.12.1 Layout.....	52
6.3.12.1.1 Lung Layout	54
6.3.12.2 Resources	56

6.3.12.2.1	Noninvasive Ventilation (NIV)	56
6.4	INTERNAL VOLUME OF THE BREATHING CIRCUIT COMPONENTS.....	57
6.4.1.1.1	External Auxiliary pressure	57
6.4.1.1.2	Tube compensation	58
6.4.1.2	Maneuver	58
6.4.1.2.1	P0.1.....	58
6.4.1.2.2	Slow Vital Capacity	59
6.4.1.2.3	P/V Flex.....	59
6.4.1.2.4	Pi Max.....	59
6.4.1.2.5	Gas Trapping Volume	60
6.4.1.3	Trend.....	61
6.4.1.3.1	Configure trend	62
6.4.1.3.2	Cursor	62
6.4.1.3.3	Events	62
6.4.1.3.4	Monitored	62
6.4.1.3.5	Page.....	63
6.4.1.3.6	Balancing	63
6.4.1.3.7	Alarms and messages	63
6.4.1.3.8	Monitor	63
6.4.1.4	Calibration.....	63
6.4.1.4.1	O ₂ cell (galvanic cell only)	63
6.4.1.5	Advanced.....	64
6.4.2	<i>Lock Button</i>	<i>64</i>
6.4.3	<i>Stand by button.....</i>	<i>64</i>
6.4.4	<i>Bargraph or monitored parameters area</i>	<i>64</i>
6.4.5	<i>Graphics area</i>	<i>64</i>
6.4.6	<i>Print Screen</i>	<i>65</i>
6.4.7	<i>Ventilation Mode Setting Area.....</i>	<i>65</i>

6.4.7.1 Ventilatory modes available	65
6.4.7.2 Adjusting ventilatory modes	67
6.4.8 Parameter setting area	67
6.5 CALIBRATIONS	68
6.5.1 Distal Flow Sensor (Envitec or reusable)	68
6.5.2 Integrated valve	68
6.5.3 O ₂ cell (galvanic cell only).....	68
6.6 AUTOMATIC COMPENSATION OF THE RESPIRATORY CIRCUIT	68
7 TROUBLESHOOTING	69
8 CLEANING, DISINFECTION AND STERILIZATION	71
8.1 FLEXIMAG MAX EXTERNAL PARTS, HOSES, AC MAINS CABLE	71
8.1.1 Cleaning	71
8.1.2 Disinfection	71
8.2 BREATHING CIRCUIT, PROXIMAL FLOW SENSOR, REUSABLE DISTAL FLOW SENSOR, SILICONE LINE, DIAPHRAGM AND INTEGRATED VALVE	72
8.2.1 Cleaning	72
8.2.1.1 Rinse	72
8.2.1.2 Drying	72
8.2.2 Disinfection	72
8.2.3 Sterilization	73
8.3 DISTAL FLOW SENSOR (ENVITEC SPIROQUANT A+)	73
8.4 IRMA CO ₂ SENSOR.....	73
8.5 OXIMETRY SENSOR (OXIMETER).....	74
8.6 IMPORTANT ADVICES	74
8.7 PROCESSING METHODS	76
9 PREVENTIVE MAINTENANCE	77
9.1 VERIFICATIONS	77

9.2 PREVENTIVE MAINTENANCE SCHEDULE	78
9.3 CONSUMABLE ITEMS.....	78
9.4 INTERNAL BATTERIES.....	78
9.5 WATER COLLECTORS WITH COALESCING FILTER.....	79
9.6 MESH FILTER	80
9.7 O ₂ CONCENTRATION CELL.....	81
10 TECHNICAL SPECIFICATIONS	83
10.1 CLASSIFICATION	83
10.1.1 <i>Class I Equipment</i>	83
10.1.2 <i>Protection class of applied parts</i>	83
10.1.3 <i>CE – Class IIB</i>	83
10.1.4 <i>ANVISA – Class III</i>	83
10.1.5 <i>FDA – Class II</i>	83
10.2 APPLICABLE STANDARDS.....	83
10.3 PHYSICAL AND ENVIRONMENTAL SPECIFICATIONS	85
10.4 ELECTRICAL SPECIFICATIONS	85
10.4.1 <i>Electrical network</i>	85
10.4.2 <i>Batteries</i>	86
10.4.3 <i>External DC Power Supply</i>	86
10.4.4 <i>Connectors</i>	87
10.4.4.1 <i>Protocol used for data communication with external devices</i>	88
10.4.5 <i>Gas Inlet Connector</i>	89
10.5 PNEUMATIC SPECIFICATIONS	90
10.5.1 <i>Pneumatic layout</i>	90
10.6 INTERNAL FLOW TRANSDUCER SPECIFICATIONS	91
10.7 DISTAL FLOW SENSOR SPECIFICATIONS (ENVITEC OR REUSABLE).....	92
10.8 PROXIMAL FLOW SENSOR SPECIFICATIONS	92

10.9 PRESSURE SENSOR SPECIFICATIONS.....	92
10.10 GALVANIC O ₂ CELL SPECIFICATIONS.....	93
10.11 PARAMAGNETIC O ₂ CELL SPECIFICATION	94
10.12 VENTILATION MODES SPECIFICATIONS	95
10.12.1 VCV.....	95
10.12.2 PCV.....	97
10.12.3 PLV	99
10.12.4 PRVC.....	102
10.12.5 V-SIMV	104
10.12.6 P-SIMV.....	107
10.12.7 CPAP/PS	110
10.12.8 DualPAP	113
10.12.9 APRV.....	116
10.12.10 MMV	118
10.12.11 VS	119
10.12.12 Nasal CPAP.....	120
10.12.13 NIV	120
10.12.14 VG.....	121
10.12.15 O ₂ THERAPY.....	122
10.12.16 PRVC-SIMV	124
10.12.17 MASV.....	125
10.13 OXYGEN ADJUSTMENT RESPONSE TIME	126
10.14 ACCURACY OF SETTINGS.....	126
10.15 ADJUSTABLE PARAMETER SPECIFICATIONS	127
10.16 MONITORED PARAMETER SPECIFICATIONS	131
10.17 SAFETY SYSTEM SPECIFICATIONS	135
10.18 ALARM SYSTEM SPECIFICATION.....	135

10.18.1 Adjustable alarm specifications	136
10.18.2 Ventilator alarm messages	138
10.18.3 Ventilator Alert Messages.....	141
10.18.4 IRMA CO ₂ sensor alarm messages.....	141
10.18.5 Oximeter Alarm Messages	143
10.18.6 Alarm Testing.....	145
10.18.6.1 FiO ₂ alarm.....	146
10.18.6.2 Airway pressure alarm	146
10.18.6.3 Volume alarm	146
10.18.6.4 No AC power alarm	146
10.18.6.5 Low battery alarm	146
10.18.6.6 Gas supply failure alarm.....	146
10.18.6.7 PEEP alarm	146
10.18.6.8 Disconnection alarm.....	146
10.18.6.9 Obstruction alarm	147
10.18.6.10 Minute volume alarm.....	147
10.18.6.11 Respiratory rate alarm	147
10.18.6.12 Apnea alarm	147
10.18.6.13 EtCO ₂ alarm	147
10.18.6.14 ICO ₂ alarm	148
10.18.6.15 Heart rate alarm.....	148
10.18.6.16 SpO ₂ alarm.....	148
10.18.7 Battery test	148
10.19 PERFORMANCE SPECIFICATIONS	148
10.20 RESPIRATORY CIRCUIT SPECIFICATIONS	149
10.21 MAINTENANCE AND CALIBRATION SPECIFICATIONS	150
10.22 IRMA CO ₂ SENSOR SPECIFICATIONS	150

10.23 OXIMETER SPECIFICATIONS.....	153
10.24 ELECTROMAGNETIC COMPATIBILITY	154
10.24.1 Guidelines and manufacturer's declaration - Electromagnetic emissions	155
10.24.2 Guidelines and manufacturer's declaration - Electromagnetic immunity.....	156
10.24.3 Electrical safety	160
10.25 AUDIBLE ACOUSTIC ENERGY	160
10.26 MASK TO NON-INVASIVE VENTILATION	160
10.27 RESPIRATORY CIRCUIT	161
10.28 HME FILTER	161
10.29 HEPA FILTER	162
10.30 INTERNAL VOLUME OF THE BREATHING CIRCUIT COMPONENTS	162
11 IRMA CO₂ SENSOR (OPTIONAL)	164
11.1 INTENDED USE.....	164
11.2 INSTRUCTIONS FOR USE	164
11.2.1 Reset procedure	165
11.2.2 LED status information.....	166
11.3 PREVENTIVE MAINTENANCE.....	166
11.4 IMPORTANT NOTICES	166
12 PULSE OXIMETER (OPTIONAL).....	169
12.1 INTENDED USE.....	169
12.2 PRINCIPLE OF OPERATION	169
12.3 IMPORTANT NOTICES	171
13 TECHNICAL SERVICE	176
14 DISCARD.....	177
15 SYMBOLOGY	178
15.1 SYMBOLS USED IN THE EQUIPMENT	178
15.2 SYMBOLS USED IN PACKAGING AND LABELING	179

16 ABBREVIATIONS AND TERMS USED	181
17 BIOCOMPATIBILITY STATEMENT	183
18 WARRANTY	184
19 TRAINING	185
ANNEX I – DIFFERENCES BETWEEN MODELS	186

Table index

Table 1 - Initial Verifications	24
Table 2 - Components that accompany FlexiMag Max	24
Table 3 - OPTIONAL parts and accessories	26
Table 4 - Verification before use	42
Table 5 - Ventilatory modes	65
Table 6 – Sterilizable accessories	73
Table 7 – Processing methods	76
Table 8 – Preventive maintenance schedule	78
Table 9 – Consumable items replacement	78
Table 10 - Physical and environmental specifications	85
Table 11 – Electrical network	85
Table 12 - Batteries	86
Table 13 – External DC power supply	86
Table 14 - Connectors	87
Table 15 - Gas Inlet Connector	89
Table 16 - Internal Flow Transducer - General Specifications	91
Table 17 - Distal Flow Sensor (Envitec or reusable) - General Specifications	92
Table 18 - Proximal Flow Sensor - General Specifications ADULT	92
Table 19 - Pressure sensor - General specifications	92

Table 20 – Galvanic O ₂ cell specifications	93
Table 21 – Paramagnetic O ₂ cell specification	94
Table 22 – Oxygen adjustment response time	126
Table 23 – Accuracy of settings	126
Table 24 – Uncertainty of settings	127
Table 25 - Adjustable parameters	127
Table 26 - Monitored ventilatory parameters	131
Table 27 - Alarm Priority	135
Table 28 - Alarms Characteristics	136
Table 29 - Adjustable alarms	136
Table 30 - High priority alarms	138
Table 31 - Medium Priority Alarms	139
Table 32 - Low priority alarms	140
Table 33 - Alert messages	141
Table 34 - High priority alarms	141
Table 35 - Medium Priority Alarms	142
Table 36 - Low priority alarms	142
Table 37 - Messages	142
Table 38 - High priority alarms	143
Table 39 - Medium Priority Alarms	144
Table 40 - Low priority alarms	145
Table 41 - Messages	145
Table 42 - Performance specifications	148
Table 43 - Expiratory and inspiratory branch resistance specifications	149
Table 44 - Respiratory circuit compliance specification	149
Table 45 - Operation Specifications	150
Table 46 - Maintenance and calibration specifications	150

Table 47 - IRMA CO ₂ sensor - General specifications.....	150
Table 48 - IRMA CO ₂ Sensor - Outputs.....	151
Table 49 - IRMA CO ₂ sensor - Gas analyzer.....	151
Table 50 - IRMA CO ₂ sensor – Accuracy I	152
Table 51 - IRMA CO ₂ sensor - Accuracy II	152
Table 52 - IRMA CO ₂ sensor - Effects of gas and vapor interference	152
Table 53 – Effects from Water Vapor Partial Pressure on Gas Readings.....	153
Table 54 – Performance specifications.....	153
Table 55 – Environmental specifications	154
Table 56 – Audible acoustic energy specification.....	160
Table 57 – Mask to NIV ventilation specification	160
Table 58 – Respiratory circuit specification	161
Table 59 – HME filter specification	161
Table 60 – HEPA filter specification.....	162
Table 61 - Internal volume of the breathing circuit components.....	162
Table 62 - IRMA CO ₂ Status LEDs	166
Table 63 - Symbols used in the equipment.....	178
Table 64 - Symbols used in packaging and labeling	179
Table 65 - Abbreviations and terms used	181

1 Safety Notes

1.1 Definitions



WARNING

- *Informs the user of the possibility of injury, death or other serious adverse reaction associated with the use or misuse of the equipment.*
-



ATTENTION

- *Informs the user of the possibility of equipment failure associated with the use or misuse, such as: malfunction, damage to the equipment itself, damage to third party assets and indirect injury to the patient.*
-



Observations

- *Important information to observe.*
-

1.2 Warning

Warning

- Whenever there is a  symbol, consult this manual for more information.
- This manual shall be read in its entirety carefully to ensure correct and safe use of the equipment and to provide maximum safety and the best resources to the patient. Observe all "WARNING" and "ATTENTION" contained in this manual and on the labeling of the equipment.
- The equipment shall be used only for the purpose specified in Intended Use (Chapter 2.1) and with appropriate monitoring.
- The equipment shall be operated by trained and qualified personnel, who shall maintain vigilance during use, including in volume limited ventilation, so that in case of malfunction or failure, help is available immediately.
- **Explosion Hazard:** This equipment is not approved for use with flammable anesthetic agents.
- Equipment may be adversely affected and may be subject to interference from certain transmitting equipment, such as cellular telephones, walkie-talkie, cordless telephones, pagers, high frequency surgical equipment (diathermy), and shortwave therapy, which may interrupt the operation of the equipment. Do not use this transmission equipment near the ventilator.
- This equipment shall not be used during a nuclear magnetic resonance (MTR, NMR, NMI), as it may cause interference, causing adverse effects to the patient.
- Before first use or after use on each patient, clean the equipment as indicated in chapter 8.
- When powering up the equipment, perform basic scanning and adjustment procedures. Follow the instructions in chapter 5.
- ALARMS and WARNINGS shall be promptly serviced in order to maintain the integrity of the equipment operation and patient safety.
- Do not use electrically conductive antistatic hoses or tubes in the respiratory system of the ventilator.
- Always check that the equipment is correctly set before using it.
- After starting the ventilation, using monitoring verify if ventilatory parameters are adequate.
- Use only MAGNAMED accessories listed in this manual, which have been tested and approved for use in conjunction with this equipment. Otherwise, functionality of the equipment may be compromised.
- During prolonged use of the equipment with patients with excess secretion and / or using a heated humidifier, the condition of the flow sensor shall be checked frequently,

attempting to drain accumulated fluids in the respiratory circuit when necessary.

- *Keep the equipment connected to an electrical source even when it is turned off, so that the internal batteries are always charged.*
- *After using the equipment or after an extended period of storage, fully recharge the batteries.*
- *If LOW BATTERY alarm occurs, IMMEDIATELY connect the ventilator to an electrical Network. If this is not possible, provide another suitable means of ventilatory support and then DISCONNECT patient equipment.*
- *Recharge the batteries before the next use, otherwise, any electrical power failure may interrupt the operation of the ventilator.*
- *Always check that there are no obstructions, as it is extremely important for a correct monitoring of ventilatory parameters that the respiratory circuit is completely unobstructed.*
- *Never obstruct the pressure connections. The pressures measured at these points are used by the patient monitoring system.*
- *After use, reusable respiratory circuit components shall go through a high-level disinfection process before their next use.*
- *All parts of the equipment that come in contact with fluids from the patient SHALL be discarded, disinfected, sterilized or disposed of as potentially infectious hospital waste.*
- *All parts of the FlexiMag Max that are in the gas passage way, including accessories and applied parts, are made of non-toxic, latex-free and phthalate-free material and do not cause irritation or allergy to the patient.*
- *Common use non-exclusive FlexiMag Max accessories, such as masks, circuits, nebulizers, humidifiers, HME filters, among others, shall be registered with local government.*
- *Do not use the equipment if a problem cannot be solved.*
- *Have a manual ventilation device available for the case of complete discharge of the battery, lack of gases for the operation of the device or even for general failure of the ventilator. The absence of manual ventilation in these cases may result in death of the patient.*
- *Always use officially approved oxygen cylinders and pressure reducing valves that meet local government requirements.*
- *For proper ventilation, when adjusting the ventilator, take into consideration the dead spaces of the respiratory circuit, especially for low tidal volumes.*
- *The ventilator shall not be covered or positioned in such a way that operation or performance is affected.*
- *When components of the respiratory circuit or other components or subassemblies are added to the respiratory system of the ventilator, the pressure gradient across the respiratory system, measured relative to the patient's port of attachment, may increase, adversely affecting the performance of the ventilator.*

-
- ***Nebulization or humidification can increase the resistance of respiratory system filters. The operator shall often monitor increased resistance and filter blockage of the respiratory system.***
 - ***The ventilator cannot be used in a hyperbaric chamber. Such use might cause the ventilator to not function correctly, causing patient death or serious deterioration of health.***
 - ***Only use air and oxygen in the gas inlet of the equipment. Do not use nitric oxide, helium or other gases.***
 - ***The expiratory branch may become contaminated with bodily fluids or expired gases during use of the equipment under normal conditions and under a single fault.***
 - ***HME filter, HEPA filter and airway adapter are single use. The reuse of these accessories may cause cross contamination.***
 - ***The distal flow sensor is for single patient use and shall be discarded when changing patients. Re-use for another patient may result in cross-contamination.***
 - ***FlexiMag Max does not generate sub atmospheric pressure during the expiratory phase.***
 - ***The responsible organization is responsible for ensuring the compatibility of the ventilator and all of the parts used to connect to the patient before use.***
 - ***Always have immediate access to an alternative means of ventilation, which is ready for use, in order to reduce the possibility of patient death or serious deterioration of health.***
 - ***It is the responsibility of the responsible organization to ensure that the oxygen source is compatible with the rated range of pressure, flowrate and oxygen concentration as marked on the ventilator and indicated in the instructions for use as this can affect the performance of the ventilator that can consequently result in patient death or serious deterioration of health.***
 - ***Do not modify this equipment without the authorization of the manufacturer.***
 - ***If any serious incident occurs in relation to the device, the user and/or patient should report the manufacturer and the competent authority of the Member State in which the user and/or patient is established.***
 - ***Before use the equipment and accessories, open the packages carefully and remove the items from their packages.***
 - ***The ventilator accuracy can be affected by the gas added to the ventilator breathing system by use of a pneumatic nebulizer.***
 - ***Ventilator may not detect decannulation/disconnection when operating at minimum pressure. If there is partial obstruction, the ventilator may misinterpret this as a pressure problem.***
-

1.3 Attention

ATTENTION

- *This ICU ventilator does not emit electromagnetic waves that may interfere with the operation of equipment in its vicinity.*
- *Perform all maintenance according to the operating time specified in this manual.*
- *All service, modification or maintenance on the ventilator can only be carried out by qualified technician, trained and duly authorized by MAGNAMED.*
- *Only use parts, cables, sensors, filters and breathing circuits specified by MAGNAMED and compatible with the system. For purchase, please inform the codes presented in the corresponding chapter.*

1.4 Observation

Observations

- *The technical specifications of MAGNAMED products are subject to change without notice.*

2 Features

2.1 Intended Use

FlexiMag Max's ventilator family has been developed to provide invasive and non-invasive ventilatory support with complete ventilatory monitoring for neonatal, pediatric and adult patients with impaired respiratory function in postoperative intensive care units in post-anesthetic recovery rooms (RPA), or for in-hospital transport.

2.2 Principle of Operation

FlexiMag Max is a family of a micro processed electronic lung ventilators whose principle of operation is based on the integration between specific modules:

- Pneumatic module (manifold)
- Electronic Control Module
- Electronic interface module

At the entrance of the pneumatic module, two valves regulate the pressure of the gases coming from the hospital network or cylinders, trying to assure a suitable range to the equipment.

Together with these regulating valves, there are microswitches or limit switches that constantly monitor the gas pressure, so that the insufficiency or absence of pressure of one or both gases is immediately indicated by a priority alarm.

Subsequently, electronically controlled air¹ and O₂ proportional valves regulate the flow of gases accurately to ensure concentration and volume appropriate to each situation.

For the models Fleximag Max 300 and Fleximag Max 700, the ventilator relies on the FlowAir system², consisting of a turbine to electronically control the flow of air.

After their respective flows are adjusted, the gases are mixed to make the measurement of the O₂ concentration and the measurement of the resulting flow.

The O₂ concentration is obtained through a galvanic cell or optionally, a paramagnetic cell by indirect contact with the gas of the patient, through the passage of gas in the sensor.

¹ Only for Fleximag Max 500 and Fleximag Max 700 models

² Only for Fleximag Max 300 and Fleximag Max 700 models

The resulting flow measurement is performed by a high precision internal flow sensor, which guarantees an adequate reading, without the need for recalibrations and has mass flow technology, whose reading is independent of temperature or pressure.

The flow expired by the patient is measured by an external sensor, of the thermal type or hot wire anemometer, connected to the expiratory valve. Optionally, this flow can be read through a proximal flow sensor, connected to the patient's "Y" output, whose measurement is based on the pressure differential between two points.

The system pressures are taken through points in the pneumatic module, which are connected to the transducers in the electronic control module. The maximum ventilator pressure is guaranteed by the control system, which monitors the pressure in the system through transducers by setting the PR Limit or PR Control. The pressure can be relieved by expiratory valve opening and overpressure.

All these flow and pressure measurements are converted into digital signals by the electronic control module and serve to feed the control algorithm uninterruptedly, ensuring a gradual and safe adjustment of the ventilatory process.

The pneumatic module also includes safety valves, such as the overpressure valve and the anti-asphyxiation valve.

The input and output of information are processed by the electronic interface module. The information entered by the operator, via touch screen or via button, is translated, interpreted and sent to the electronic control module by serial communication, through secure protocols. Through this information the ventilator establishes the appropriate parameters to act in each different situation.

As soon as it receives information, the control module also sends it to the interface module. All measured or calculated data are also sent, via serial, to the interface module. It is up to this module to treat and display this information to the operator in a friendly and intuitive way.

All risk situations that require operator intervention are analyzed by the control module and sent to the interface module that then issues, according to the degree of risk, the necessary alarms or alerts.

Fleximag Max forms an electromedical system with the humidification system.

Observations

- *Parts and pieces indicated in this manual may be used in the patient's environment.*
- *In the absence of one of the gases, the ventilator will continue to ventilate with the remaining gas, maintaining basic operation and essential performance.*

2.3 General features

- Integration of the entire system into a single low volume and weight electronic pneumatic module;
- Electronic flow control system for the patient, using digital technology;
- Intelligent and integrated alarm system with all safety systems required by national and international standards;
- Power backup system;
- Possibility to use the parameter adjustment performed before the equipment was switched off;
- Volatile storage (while the equipment is not turned off), of all parameters, for each ventilatory mode, allowing a quick return to previously used settings (e.g. weaning);
- Fully adjustable equipment via both the touch screen and the turn-confirm button;
- Adjustable resistance compensation for both endotracheal and tracheostomy tubes;
- Volume compensation / compliance according to the respiratory circuit;
- Automatic altitude compensation;
- Automatic barometric pressure compensation.
- Leak Compensation;
- Trend charts, with memorization of the last 240 hours of ventilation;
- Resources for evaluating the patient's respiratory mechanics (P0.1, Vital Capacity, PV Inflection Points, Maximum Pi, Trapped Volume);
- Inspiratory and expiratory hold with variable time, determined by the operator;
- Freezing and saving up to 2 simultaneous loops (PxV, VxF and PxF);
- Complete monitoring;
- Additional monitor with data related to the respiratory mechanics of the patient;
- Breath adjustment option in controlled volume ventilatory modes;
- Alarm mute time adjustment option;
- Time adjustment and O₂ concentration for aspiration Option;
- Monitor with complete ventilation graphics:
 - Pressure x Time Curve
 - Flow x Time Curve
 - Volume x Time Curve
 - Pressure x Volume Loop
 - Volume x Stream Loop
 - Pressure x Flow loop
- Instant pressure bar graph with numerical indicator of peak, plateau or instantaneous pressure;
- Color-coded differentiation of ventilator or patient triggers in all phases of the controlled, assisted and spontaneous cycle.



ATTENTION

- *This equipment shall be operated only by qualified personnel and properly trained for its use.*
-

2.4 Technical Characteristics

- 15 "color liquid crystal display (LCD TFT) with 360 degree rotation and screen angle, 1024 x 768-pixel resolution, touch sensitive;
- Screen configurable for night mode;
- Control Boards with:
 - Presentation of the data in the display;
 - Processor IMX6 SOM-IMX6;
- Hotkeys for:
 - STAND BY
 - SILENCE OF ALARMS (2 min)
 - O₂ + (oxygen flush)
 - MANUAL (manual trigger)
 - INSP HOLD (inspiratory hold)
 - EXP HOLD (expiratory hold)
 - FREEZE (freeze graphics)
 - LOCK (keyboard lock)
 - NEB / TGI (Nebulizer or TGI)
 - MODE (ventilatory modes)
 - MENU (displays more options)
 - EVENTS (displays active and historical alarms)
 - PATIENT (adjusts patient data)
 - BATTERY (Displays advanced battery information)
- Pressure reading in respiratory circuit;
- Regulated pressure reading;
- Network pressure reading;
- Auxiliary pressure reading;
- Barometric pressure reading;
- Reading of the O₂ concentration in the gas mixture administered;
- Speaker for alarms and alerts;
- High brightness LED for prompt identification of alarms with 360-degree visibility;

-
- GREEN LED indicator for power supply connection, being switched on when the equipment is connected to a power supply and off when the equipment is being powered by the battery only;
 - Single distal flow sensor for all patient types;
 - Proximal flow sensor for each type of patient;
 - Internal flow sensor for all patient types;
 - External input 100-240 VAC - 50 - 60 Hz;
 - On-off key;
 - O₂ cell galvanic or optionally paramagnetic (non-consumable);
 - Nebulizer or TGI;
 - Volume, pressure and concentration compensation when used with nebulizer;
 - Stand with locking 5" wheels that allow 360° rotary movement, heated humidifier support;
 - Simultaneous input for oximetry and capnography sensor;
 - Nursing Call Out;
 - FlowAir system consisting of high-performance high-flow turbine and anti-noise system¹;
 - High flow therapy (flowmeter mode);
 - Software Updates via USB;
 - Engineering mode;
 - Maintenance mode for technical assistance;
 - Low O₂ pressure inlet⁽¹⁾;
 - HL7 Protocol;
 - Standard Ethernet Connector that enables HL7 protocol communication;
 - RS-232C serial interface;
 - Adult, pediatric and neonatal respiratory circuit;

2.5 Safety features

- Anti-asphyxia valve for protection against gas supply failure.
- 100hPa relief valve, in compliance with the basic standard of ventilators, avoiding possible overpressure in the respiratory circuit.

¹ Only for Fleximag Max 300 and Fleximag Max 700

3 Unpacking the Product

3.1 Initial Verifications

Observations

- *If the package is damaged, DO NOT OPEN and report immediately to the carrier responsible and to Magnamed.*
-

Table 1 - Initial Verifications

Step	Procedure
1	Check that the packaging is intact, making sure there are no dents, punctures or any other form of damage.
2	Open the package carefully, following the indications on the box.
3	Check the contents of the package.

3.2 List of Components

The following items are an integral part of the equipment and are for the exclusive use of the equipment:

Table 2 - Components that accompany FlexiMag Max

Item	Code	Description	Qty.	UNI
1	1106630	FLEXIMAG MAX 700 - LUNG VENTILATOR NEONATE TO ADULT	1	PC
	1107270	FLEXIMAG MAX 500 - LUNG VENTILATOR NEONATE TO ADULT	1	PC

Item	Code	Description	Qty.	UNI
	1107240	FLEXIMAG MAX 300 - LUNG VENTILATOR NEONATE TO ADULT	1	PC
2	1703938	KIT 5 SENSORS SPIROQUANT ENVITEC CE 0123	1	PC
3	1708046	ARTICULATED ARM TO SUPPORT RESPIRATORY CIRCUITS	1	PC
4	1707451	ADULT RESP. CIRCUIT W/ AUTOCLAV. COLLECTOR STRAIGHT Y W/ TEMP. SENSOR CAP	1	PC
5	3806842	DIAPHRAGM FOR INTEGRATED VALVE SET	1	PC
6	3806167	INTEGRATED VALVE SET	1	PC
7	3002739	M5X12 SCREW PHS INOX	4	PC
8	9003365	3/16 PHILLIPS KEY	1	PC
9	2807749	3 WAY MOUNTED AC NETWORK CABLE 3M - NBR 14136	1	PC
10	1106630-NE-171-RR	OPERATION MANUAL	1	PC
11	7007022	QUICK GUIDE - FLEXIMAG MAX	1	PC

Item	Code	Description	Qty.	UNI
12 ⁽¹⁾	3903114 ⁽¹⁾	COMPRESSED AIR DISS X2 3M HOSE ⁽¹⁾	1	PC
13	3902647	O2 DISS X2 HOSE	1	PC

3.3 Optional Parts and Accessories

ATTENTION

- *Always use original parts and accessories to ensure the safety and efficacy of the equipment.*

Table 3 - OPTIONAL parts and accessories

Item	Code	Description	Qty.	UNI
1	1707453	NEO RESP. CIRCUIT W/ AUTOCLAV. COLLECTOR Y 90° W/ TEMP. SENSOR CAP	1	PC
2	1707452	INF RESP. CIRCUIT W/ AUTOCLAV. COLLECTOR Y 90° W/ TEMP. SENSOR CAP	1	PC
3	1704601	RESPIRATORY CIRCUIT - ADULT 1.6M STRAIGHT Y AUTOCLAVABLE	1	PC
4	1704603	RESPIRATORY CIRCUIT - PEDIATRIC 1.6M Y 90 - AUTOCLAVABLE	1	PC
5	1704396	CO ₂ MAINSTREAM SENSOR WITH INTERCONNECTION CABLE AND 5 ADULT AIRWAY ADAPTER CE 0413	1	PC
6	1704409	PULSE OXIMETER SPO ₂ MASIMO - ADAPTER CABLE AND PED-ADU SENSOR CE 0123	1	PC
7	1704410	PULSE OXIMETER SPO ₂ MASIMO - ADAPTER CABLE AND NEONATAL SENSOR CE 0123	1	PC
8	3201100	ADULT FLOW SENSOR - AUTOCLAVABLE	1	PC

¹ Only for Fleximag Max 500 and Fleximag Max 700

Item	Code	Description	Qty.	UNI
9	3201099	INFANT FLOW SENSOR - AUTOCLAVABLE	1	PC
10	3201098	NEONATAL FLOW SENSOR - AUTOCLAVABLE	1	PC
11	3802058	SILICONE LINE 1,6 M WITH UNIVERSAL CONNECTOR	1	PC
12	1704395	CO ₂ SENSOR ADULT AIRWAY ADAPTER CE 0413	1	PC
13	1704394	CO ₂ SENSOR NEONATAL AIRWAY ADAPTER CE 0413	1	PC
14	1404881	KIT NEBULIZER SET	1	PC
15	3905085	HEPA FILTER FOR MECHANICAL VENTILATION	1	PC
16	1705142	HME FILTER NON STERIL WITH EXTENSION	1	PC
17	5008111	REUSABLE DISTAL FLOW SENSOR	1	PC
18	1708112	KIT WITH 5 REUSABLE DISTAL FLOW SENSORS	1	PC
19	1705043	KIT FLOW SENSORS ADU INF NEO AUTOCLAVABLE 1,6M	1	PC
20	1708467	FLOWAIR FILTER SET	1	PC

4 Identification of Components

4.1 Front view

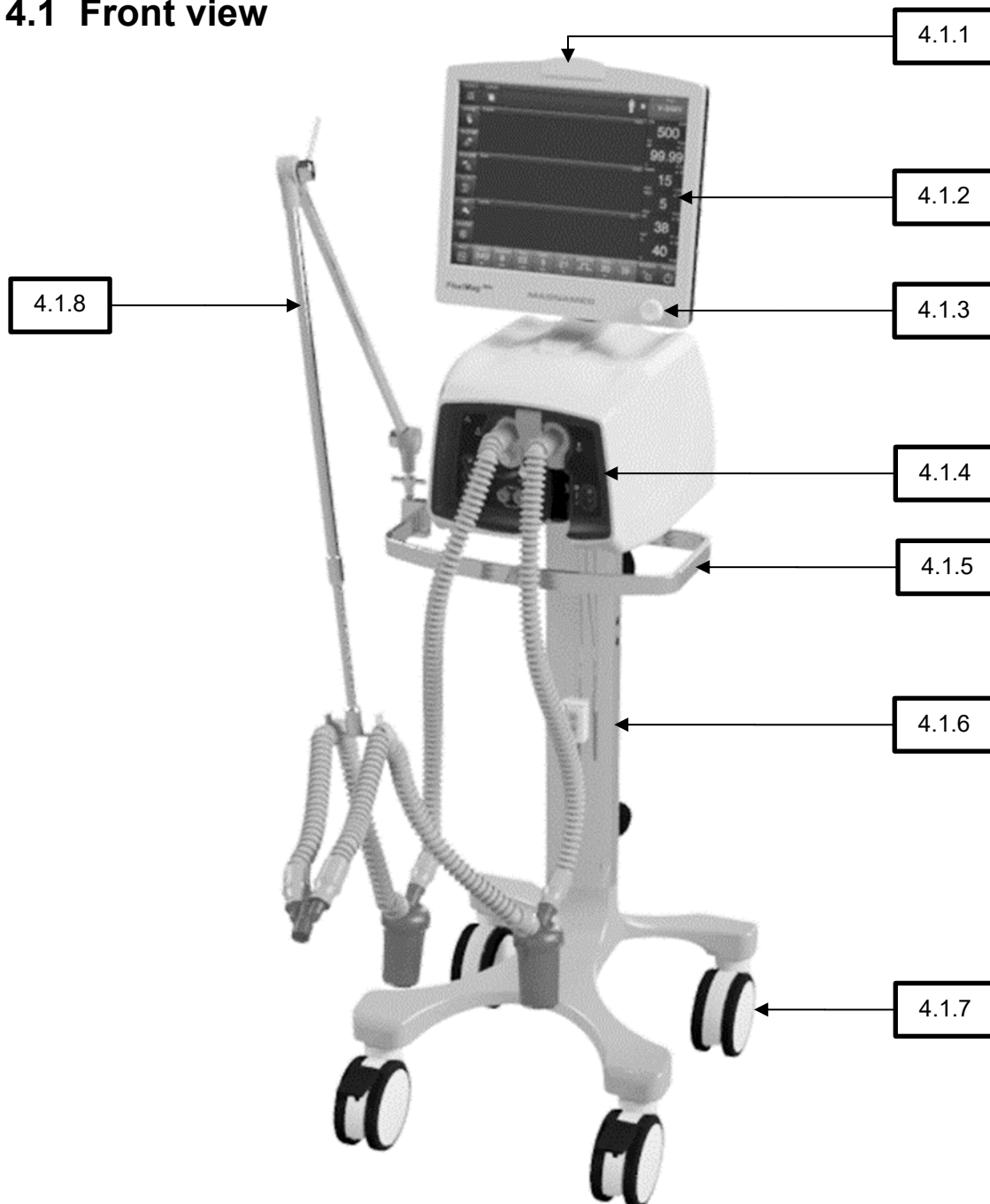

- 4.1.1 Alarm indicator light
- 4.1.2 Color and touch screen LCD monitor
- 4.1.3 Turns and confirms button with led indicator of power supply
- 4.1.4 Front panel
- 4.1.5 Carrying handle
- 4.1.6 Stand
- 4.1.7 Wheels with brakes
- 4.1.8 Articulated arm

4.1.4 Front panel

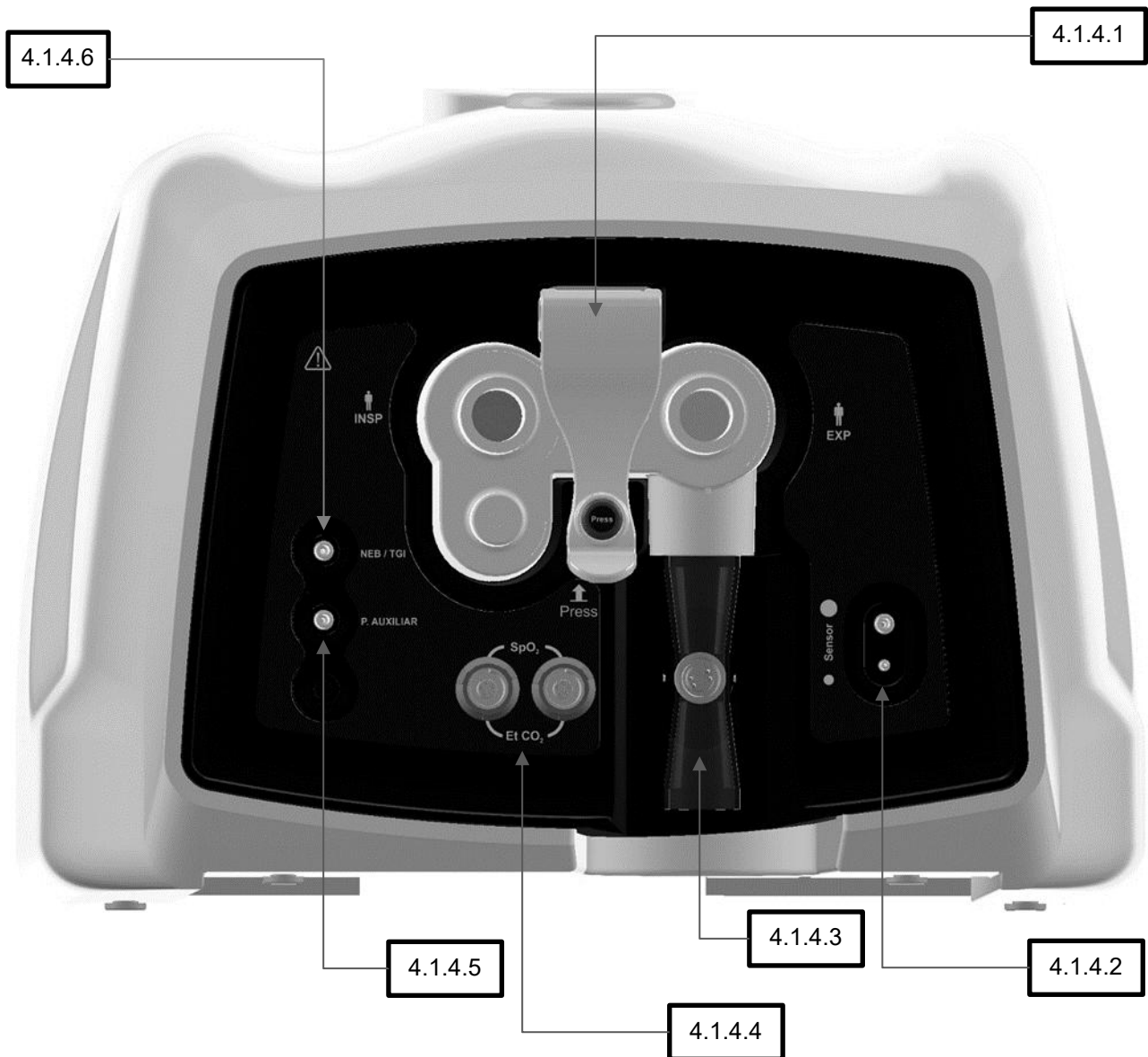

4.1.4.1 Integrated valve with inspiratory and expiratory branch connector

4.1.4.2 Nozzles for connecting proximal flow sensor lines

4.1.4.3 Distal sensor

4.1.4.4 Connector for external sensors (capnograph and oximeter)

4.1.4.5 External auxiliary pressure reading nozzle

4.1.4.6 Connector for nebulizer or TGI

4.2 Back view¹

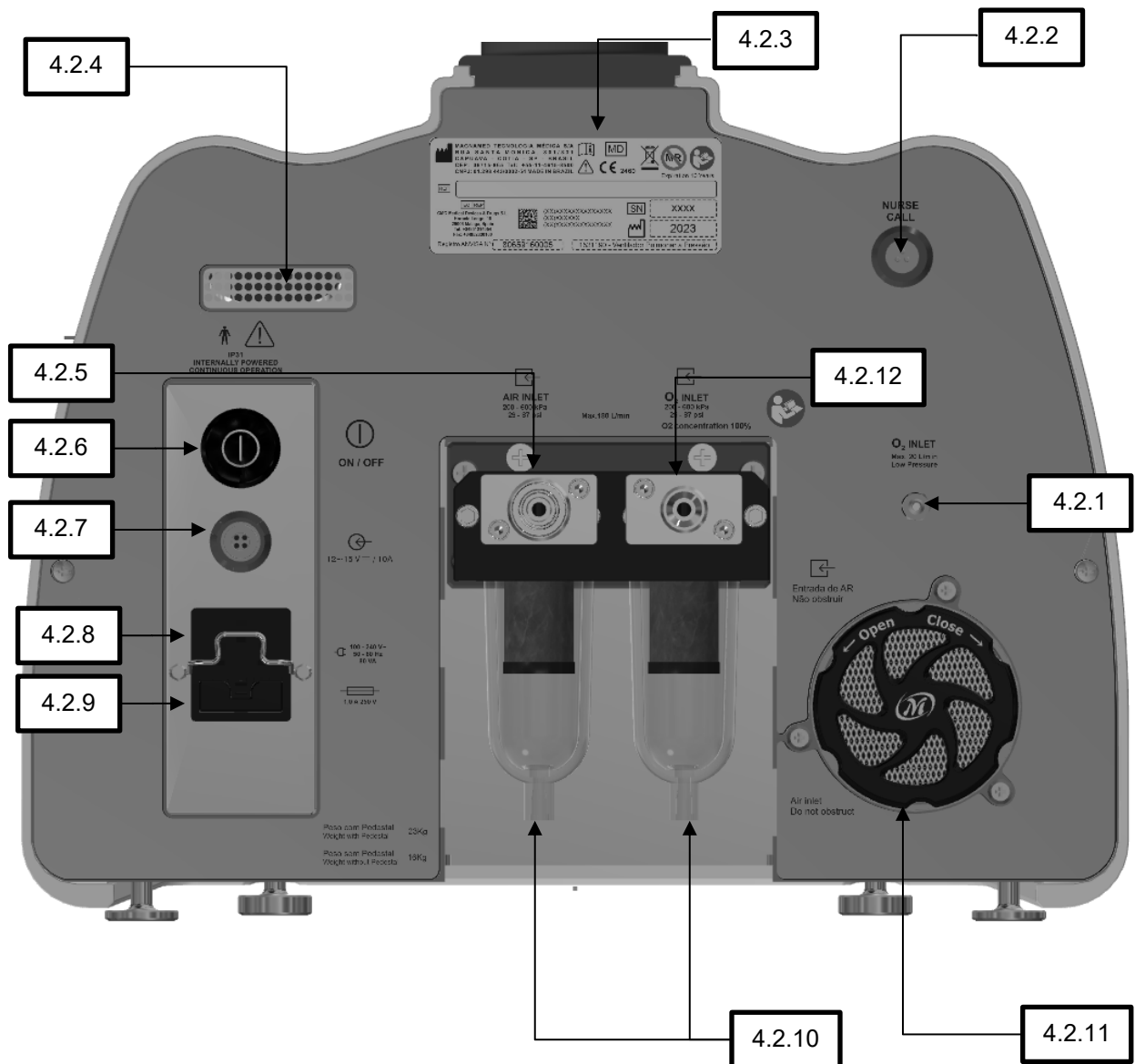

4.2.1 Low pressure O₂ inlet²³

4.2.2 Nursing call

4.2.3 Identification label

4.2.4 Air outlet for cooling

4.2.5 Compressed air inlet for connection to the air extension ⁴

4.2.6 Push on/off power button

4.2.7 Input for external power supply

4.2.8 Input for electrical energy

4.2.9 Fuse Holders

4.2.10 Water collectors with coalescing filter for gas under high pressure

4.2.11 Mesh filter³

4.2.12 Oxygen gas input for connection to the O₂ extension

¹ Back view of Fleximag Max 700 model

² For enrichment of the gas sent by the FlowAir system through the connection of a fluxometer

³ Only for Fleximag Max 300 and Fleximag Max 700 models

⁴ Only for Fleximag Max 500 and Fleximag Max 700 models

4.3 View from the bottom of the display

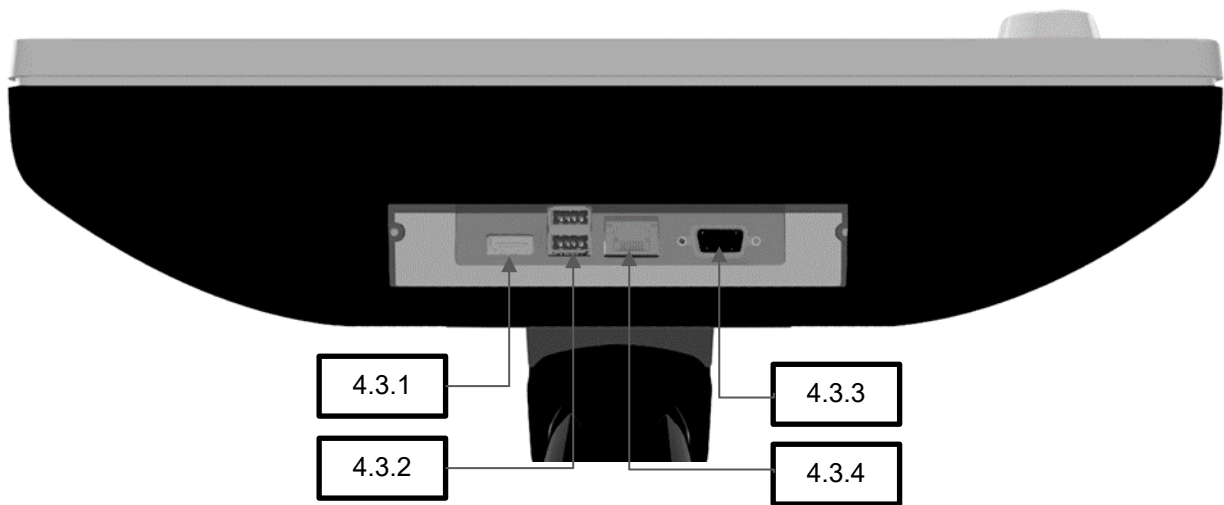

4.3.1 Standard HDMI connector

4.3.2 2 Standard USB Connectors

4.3.3 Standard RJ-45 Ethernet Connector

4.3.4. Standard RS-232 connector

5 Preparation for Use

5.1 Assembly

OK	Item	Assembly Sequence	Image
<input type="checkbox"/>	1	Use the bolt and wrench that came with the equipment to screw the wheel base to the ventilator module.	---
<input type="checkbox"/>	2	<p>Position the diaphragm in the expiratory branch on the integrated valve in the position shown in the figure.</p> <p>Connect the integrated valve on the front panel.</p> <p>Push the valve lock lever and turn the knob clockwise to lock.</p>	

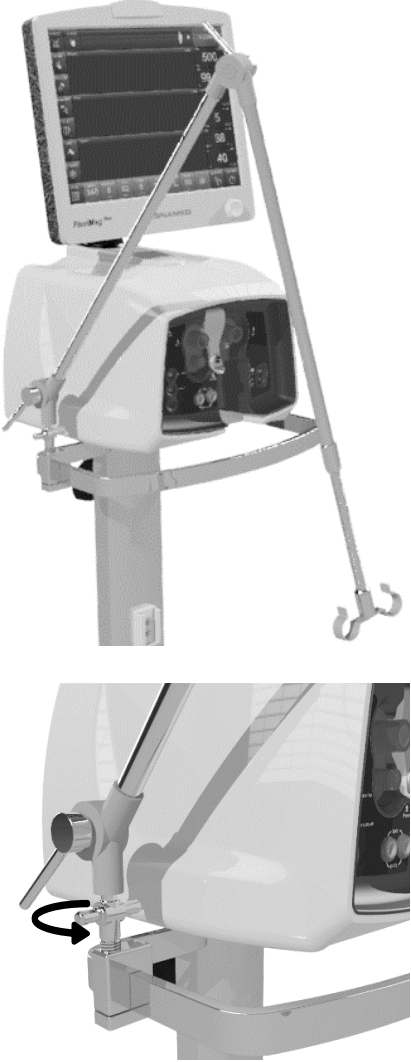

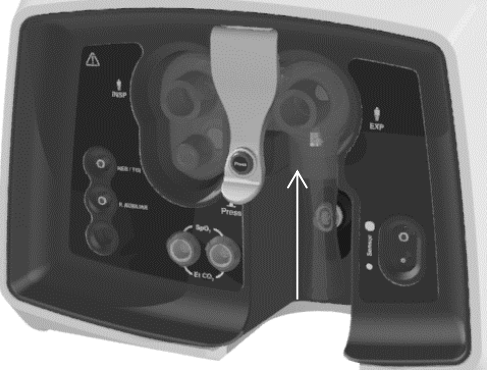
OK	Item	Assembly Sequence	Image
		<p>Check that the lever is fixed.</p> <p>ATTENTION</p> <ul style="list-style-type: none"> To remove the integrated valve, turn the knob counterclockwise. 	
<input type="checkbox"/>	3	<p>Attach the articulated arm to the transport handle and rotate the handle to secure.</p>	

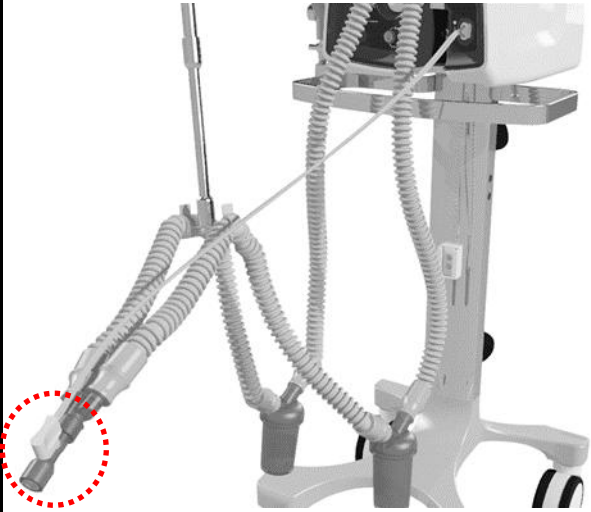
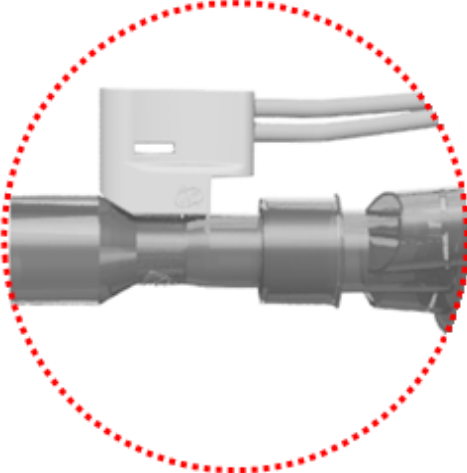

OK	Item	Assembly Sequence	Image
<input type="checkbox"/>	4	<p>Connect the patient circuit in the inspiratory and expiratory branches of the integrated valve and position on the articulated arm according to the image.</p>	
<input type="checkbox"/>	5	<p>Connect the flow sensor.</p> <p>A. Envitec Distal Sensor: Connect the sensor to the integrated valve.</p>	

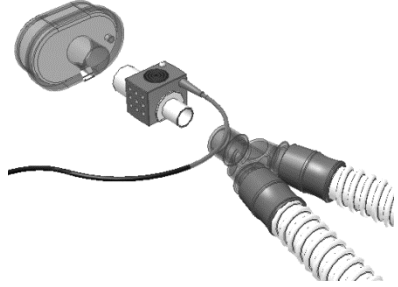

OK	Item	Assembly Sequence	Image
		<p>B. Proximal sensor: Connect the proximal sensor line as shown in the figure to the right. Connect the flow sensor to the patient's respiratory circuit after the Y. Connect the other end of the proximal sensor line to the flow sensor in the position shown in the figure on the right.</p> <div data-bbox="363 1055 858 1115" style="background-color: black; color: white; padding: 5px;">  ATTENTION </div> <ul style="list-style-type: none"> <li data-bbox="411 1151 839 1464">• <i>The flow sensor connectors shall face up to avoid condensation and accumulation of secretion at the measurement points.</i> 	 



OK	Item	Assembly Sequence	Image
<input type="checkbox"/>	6	<p>When using a humidifier, connect the inspiratory branch to the humidifier as shown in the figure.</p> <p>If a heated humidifier is used, it shall comply with ISO 80601-2-74:2017</p>	

OK	Item	Assembly Sequence	Image
<input type="checkbox"/>	7	<p>When using the IRMA CO₂ sensor, connect the airway adapter to the IRMA CO₂ sensor.</p> <p>Connect the IRMA CO₂ sensor just after the proximal flow sensor, or directly to the Y connector.</p> <p>Connect the cable to one of the external sensor connectors on the front panel.</p>	

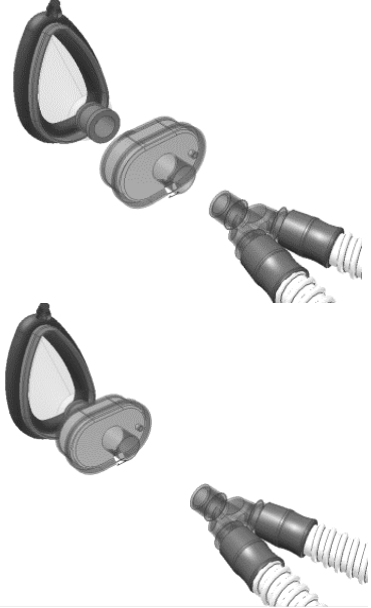
OK	Item	Assembly Sequence	Image
<input type="checkbox"/>	8	<p>If the respiratory circuit is to be used with the IRMA CO₂ sensor and the HME (Heat and Moisture Exchange) or HEPA filter (High Efficiency Particulate Air) (protection against viruses and bacteria), mount it according to the image.</p> <p>ATTENTION</p> <ul style="list-style-type: none"> • Only use filters specified by MAGNAMED. 	
<input type="checkbox"/>	9	<p>If respiratory circuit is to be used for NON-INVASIVE VENTILATION (NIV or NIV - Noninvasive Ventilation) with mask, in addition to IRMA CO₂ sensor and filter, follow the sequence according to the image.</p> <p>ATTENTION</p> <ul style="list-style-type: none"> • Use only MASKS specified by MAGNAMED. • Use MASK suitable for patient type. 	

OK	Item	Assembly Sequence	Image
<input type="checkbox"/>	10	<p>If respiratory circuit is to be used for NON-INVASIVE VENTILATION (NIV or Non-Invasive Ventilation) using the mask and without the filter, mount it according to the image.</p>	
<input type="checkbox"/>	11	<p>If the respiratory circuit is to be used for NON-INVASIVE VENTILATION (NIV or NIV - Non-Invasive Ventilation) without the CO₂ sensor. Mount it according to the image.</p>	

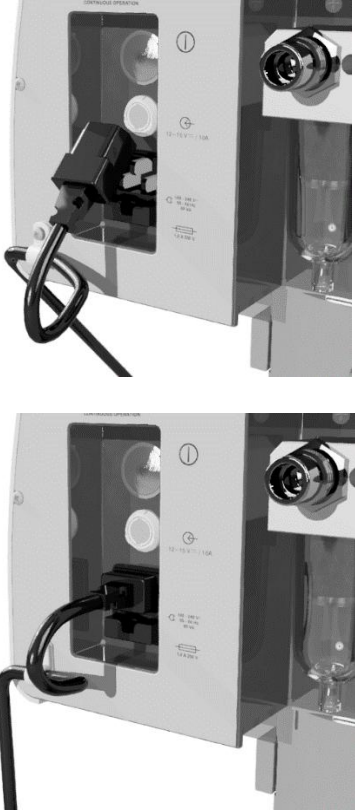
OK	Item	Assembly Sequence	Image
<input type="checkbox"/>	12	<p>If respiratory circuit is to be used for NON-INVASIVE VENTILATION (NIV) with mask and HME filter, mount it according to the image.</p>	
<input type="checkbox"/>	13	<p>If using a HEPA filter, connect the filter between the expiratory branch of the integrated valve and the expiratory branch of the patient's circuit.</p>	
<input type="checkbox"/>	14	<p>If you want to use the oximetry sensor, connect the sensor cable to the external sensor connector on the front panel.</p> <p>Position the oximetry sensor on the patient's finger.</p> <p>The oximetry sensor should be removed and the site inspected at least every 4 hours or sooner</p>	

OK	Item	Assembly Sequence	Image
		and, if indicated by circulatory status or skin integrity, reapplied to a different monitoring site.	
<input type="checkbox"/>	15	<p>Connect the power cord to the machine and to the power supply.</p>	
<input type="checkbox"/>	16	<p>Connect the compressed air hoses and O₂ as indicated, according the ventilator model.</p> <p>ATTENTION</p> <ul style="list-style-type: none"> • <i>Input pressures exceeding the specified limit can damage the equipment.</i> • <i>The hoses shall comply with ISO 5359:2008.</i> • <i>The gas network connected to the</i> 	

OK	Item	Assembly Sequence	Image
		<i>equipment shall comply with ISO 7396-1.</i>	

5.2 Electrical Network Connection

The equipment must be connected to a grounded power supply network that complies with local legislation.

The internal batteries of the equipment shall always be charged and ready for use in any power failure or for use in external operations. To do this, keep your power source connected to the electrical network to charge the batteries, even if the equipment is off. Switching between the power supply and internal battery does not affect the performance of the equipment.

After prolonged use of the equipment using only the internal battery power, it is necessary to fully recharge the equipment, preparing the equipment for the next use. During the recharge of the internal batteries, the performance of the equipment is not affected.

If the equipment remains unplugged from the electrical network for a period of more than one month, the batteries must be fully recharged.

When switching from electrical network to battery, the performance of the equipment is not affected. The "no AC power" low priority alarm is triggered, and the battery icon is displayed. If the equipment remains out of the electrical network, when the battery charge is less than 50%, the "low battery" medium priority alarm will be displayed and at least 5 minutes before the battery runs out the high priority alarm "low battery".

In case of power loss, the alarm recording system will not be affected and will keep the history as well as notify that it occurred through an alarm related to this loss.



WARNING

- *If LOW BATTERY alarm occurs, IMMEDIATELY connect the ventilator to the electrical network. If this is not possible, provide another suitable means of ventilatory support and DISCONNECT the equipment from the patient.*



Observation

- After the electrical network has been interrupted and restored while the internal battery is charged with the equipment in operation, the performance of the equipment will not be affected, and the accuracies will be maintained.
- After a period of long interruptions to the electrical network, connect the equipment to the electrical network, switch on the equipment and wait for 30 min. Perform calibrations and autotest.

When switching from battery to electrical network, the performance of the equipment is not affected. Alarms related to the battery are ceased and the battery icon is displayed.

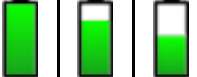
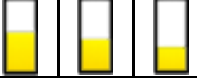
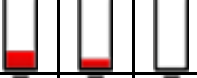
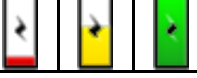

Icon	Description	Alarm
	Equipment charged and connected to electrical network	No alarm
	Equipment operating on battery, with load above 50%	Low priority "No AC power"
	Equipment operating on battery, with load between 50% and 20%	Medium priority "Low battery"
	Equipment operating on battery with load below 20%	High priority "Low battery"
	Equipment connected to electrical network and battery charging	No alarm

5.3 Verification Before Use

The purpose of this verification is to ensure greater safety through some simple and quick procedures that must be performed before each use or at least at the beginning of each work period.

Table 4 - Verification before use

Item	Procedure
1	Verify that the machine is turned off.
2	Perform a visual inspection of the equipment and its components, seeking to assess the integrity of the equipment.
3	Verify that all components are properly connected or inserted.
4	Verify that the integrated valve is installed correctly and is firmly seated. Also note the conditions of the diaphragm.

Item	Procedure
5	Verify the tight connection of the distal flow sensor to the expiratory valve.
6	Verify that the breathing circuit is firmly connected and is suitable for the patient.
7	Verify the tight connection of oxygen and compressed air hoses.
8	<p>Verify that the inlet pressure is within the specified range.</p> <div style="background-color: black; color: white; padding: 5px;"> ATTENTION</div> <ul style="list-style-type: none"> • <i>Input pressures exceeding the specified limit can damage the equipment.</i> • <i>For inlet pressures less than 250 kPa, the maximum flow shall be 120 L/min.</i>
9	<p>Check the power cord connection, if applicable.</p> <p>The ventilator can be used on battery for up to 240 minutes continuously, under normal ventilation conditions.</p> <div style="background-color: black; color: white; padding: 5px;"> WARNING</div> <ul style="list-style-type: none"> • <i>If LOW BATTERY alarm occurs, IMMEDIATELY connect the ventilator to the electrical network. If this is not possible, provide another suitable means of ventilatory support and then DISCONNECT the equipment from the patient.</i>
10	If all items are OK, then the equipment is ready for use.

 WARNING

- *Perform all verification procedures before each use.*
- *If any problem is found, correct it BEFORE USING THE DEVICE.*
- *If the problem cannot be resolved immediately, contact qualified technical assistance.*

5.4 Shutdown procedure

The lung ventilator Fleximag Max is a life support equipment and must be MANDATORILY disconnected from the patient to be turned off. The equipment should be turned off in the on/off switch, identified in 4.2 Back view (item 4.2.6). When the equipment is turned off, a continuous audio signal will be produced indicating that the equipment has been turned off. Finally, press the turn-confirm button, identified in 4.1 Front view (item 4.1.3).

6 Instructions for use

6.1 Initial Sequence

Turn on the ventilator via the push on/off button on the back of the equipment.

In less than 20s the initial screen will be present, which includes the initial screen that includes the patient options and the available services, depending on the model of ventilator purchased.

From the home screen, select the type of patient by tapping on the corresponding icon.

Once the patient type is identified, the flow sensor and humidifier adjustment screen will be displayed, and the operator will have the option to perform the autotest or initiate ventilation.

Select the type of humidifier or heat exchanger and the chosen flow sensor (distal or proximal).



ATTENTION

- ***The choice of humidifier or heat exchanger is important for proper calculation of volumes according to the temperature and humidity conditions presented (STPD or BTPS).***
- ***If you have opted for the proximal sensor, make sure it matches the type of patient selected (neonatal, pediatric, or adult).***
- ***Only one type of external, distal OR proximal flow sensor will be tested. If you made a mistake while selecting it, restart the equipment and redo the autotest.***
- ***In case of the use of the distal flow sensor, do not use suction system in the exhaust gas outlet.***

To perform the autotest, be sure to perform the following steps:

- The ventilator shall be disconnected from the patient.
- The ventilator should preferably be connected to the electrical network or, if this is not possible, shall have enough battery power.
- The ventilator shall be supplied with both gases (compressed air and O₂) within the recommended pressure range.
- The red LED indicating priority alarms shall remain on.
- It shall be possible to hear the alarm speaker test.
- A RESPIRATORY CIRCUIT SUITABLE FOR THE TYPE OF PATIENT SHALL BE MOUNTED AND THE OUTPUT SHALL BE OBSTRUCTED.



WARNING

- ***Never start the autotest procedure with the ventilator connected to the patient.***
-

If you heard the speaker test, answer YES. Otherwise, answer NO. In this case the equipment shall not be used and therefore, it will be inoperative until a new autotest is carried out, that is, until the equipment is restarted.

To start the autotest, press the confirm button or, if you want to start the ventilation immediately, press the ventilation button.



WARNING

- ***Never respond YES if you could not hear the speaker test under the risk of malfunctioning of the priority alarms during ventilation.***
 - ***Always perform the autotest procedure before connecting the ventilator to a patient.***
-

The autotest checks all important items for proper ventilation:

- Gas regulated pressure
- Proportional Valves
- Flow Sensors
- Expiratory valve
- O₂ cell
- Leakage
- Resistance and compliance of the respiratory circuit
- Flowair system¹

At the end of the leak test, the RESPIRATORY CIRCUIT OUTPUT SHALL BE UNOBSTRUCTED to perform the resistance test and, where appropriate, the proximal flow sensor test.



ATTENTION

- ***Do not forget to unobstructed the circuit output before the resistance test.***
-

¹ Only for Fleximag Max 300 and Fleximag Max 700



ATTENTION

- *If there is a recurring failure in one or more items of the autotest, suspend use of the equipment until the problem is resolved.*
-

The autotest can be canceled at any time by the operator. To perform only some of the tests, you must enter the RESTRICTED menu.



ATTENTION

- *The restricted menu is accessible only with a password.*
-

Once the autotest process is complete, press VENTILATION to go to the ventilation screen.



ATTENTION

- *Position the patient close to the Fleximag Max so that the breathing circuit is not stressed.*
 - *When using the respiratory circuit with water traps, keep them at a lower level to ensure correct operation of the collectors.*
-

6.2 Restricted menu

This menu is password-only accessible and allows you to make advanced settings, calibrations and autotests, and allows you to view system information, battery and status.

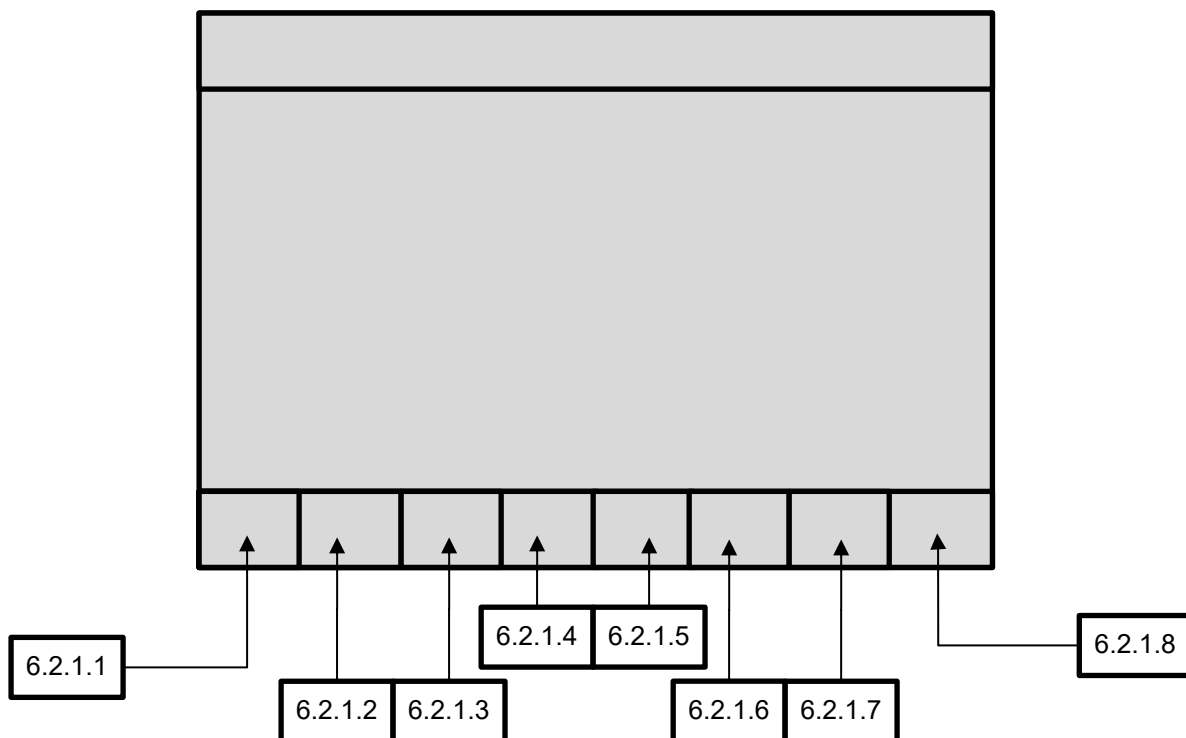

6.2.1 Patient

Clicking this button will return you to the patient screen.

6.2.2 Autotest

In this menu, you can perform the tests, and cancel and view the results individually. This menu displays the air pressure, O₂ information, date and time of the last test performed.

6.2.3 Calibration

In this menu, it is possible to perform the calibration of the distal flow sensor, expiratory valve and oxygen cell. This menu displays the air pressure, O₂ information, date and time of the last test performed.

To perform the calibrations, occlude the breathing circuit, select the items you want to calibrate, and press the calibrate button.

6.2.4 Status

This menu displays information on the total time of use of the equipment, time since the last maintenance, last test and last calibration performed, O₂ network pressure, air network pressure, date, time and IP.

6.2.5 Battery

Percentage and battery status information is displayed in this menu.

6.2.6 System

In this menu it is possible to configure date, time, language, brightness, day or night mode and audio volume. It is also possible to check the IP if the ventilator is connected to the internet and it is possible to access the Restricted mode, which gives access to the engineering mode through a password. In this mode, also using a password, it is possible to export data, such as trends, black boxes and screenshots to a USB memory.



ATTENTION

- *Make sure that the volume adjusted for the audio of the alarms is compatible with the distance that the equipment will be from the clinicians.*

6.2.7 Advanced

In this menu you can adjust time and O₂+ concentration, inspiratory and expiratory hold time, keypad lock time, alarm mute time, type of controlled volume adjustment (switch to flow, I:E ratio and insp time), type of flow sensor and pressure unit.

6.2.8 Ventilation

This menu gives access to the main ventilation screen of the patient.

To ventilate, remove the ventilator from standby mode by pressing and holding the respective button located in the quick access function area for 2 (two) seconds.



WARNING

- *Whenever it is restarted, the ventilator will enter **STAND BY** mode and in this condition the patient will not be ventilated.*

6.3 Main screen

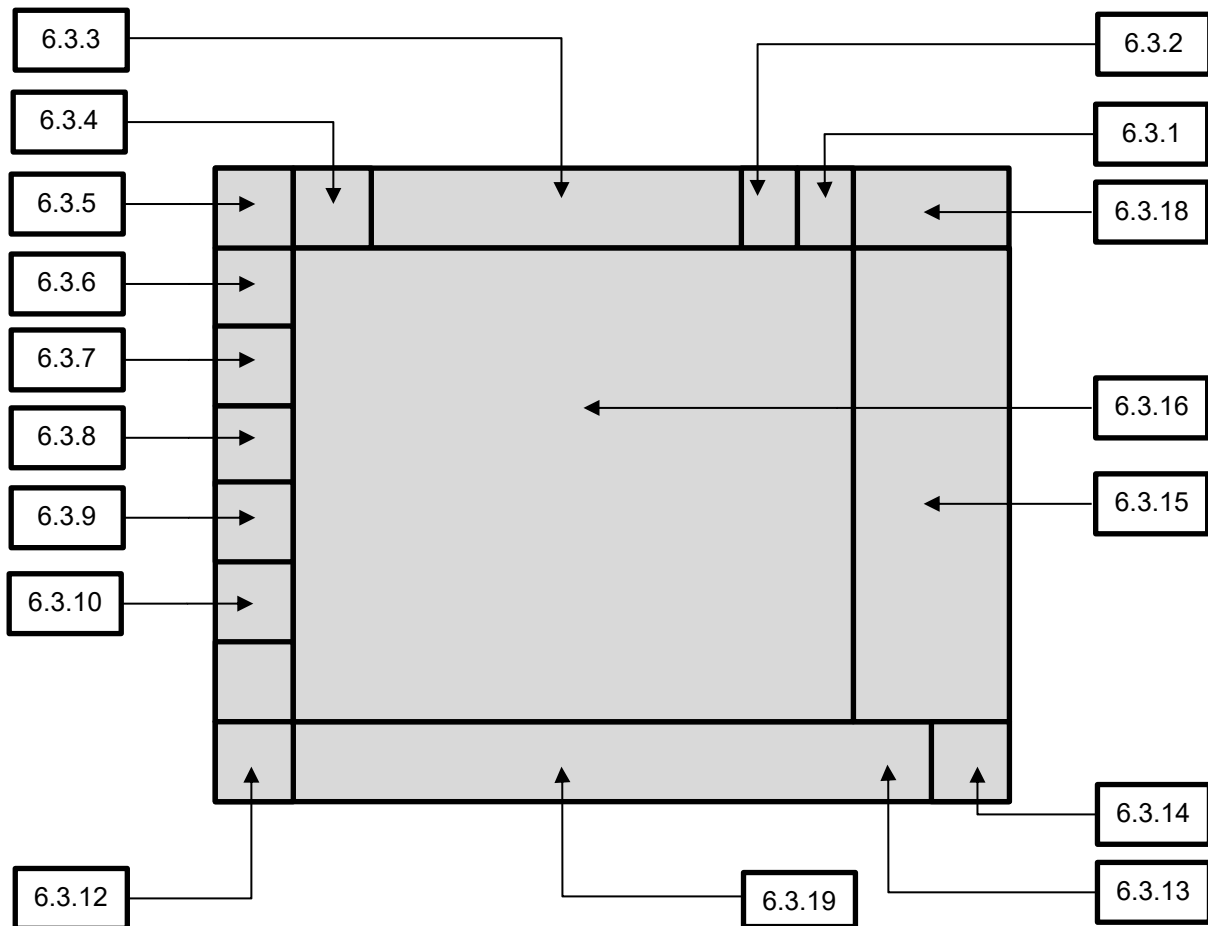

6.3.1 Battery status area

Percentage and battery status information is displayed in this menu.

6.3.2 Patient information area

Patient information such as ID, name, initials, last name, sex, height, and volume / weight are set in this menu.

6.3.2.1 Volume x weight patient definition

Once a patient is selected, the ventilator automatically estimates an adequate tidal volume. However, to obtain the best current volume is important to know the ideal weight for each patient.

It is possible to obtain the ideal weight for pediatric and adult patients according to sex and height. To do so, simply select the patient's sex and then adjust the height value, so that the equipment calculates your

ideal weight. The parameter setting volume by weight (ml per kilogram) complements the information necessary to better fit the current volume.

For neonatal patient, the ventilator estimates the adequate tidal volume according to the body weight of the patient. To do so, simply select the patient's sex and then adjust the weight value.

Observation

- *To reduce the risk of lung injury, the ventilator uses the ideal weight as a reference for adjusting ventilatory parameters. If you want to change the parameters set by the ventilator, simply select the parameter and change it.*

6.3.3 Historical events area

This menu displays the history of events related to alarms, ventilation, maneuver, settings, battery, calibration, actions and tests.

6.3.4 Alarm setting area

For each of the alarms directly related to the ventilation process, there are one or two limits (high value and low value) to be adjusted. These limits are set directly in the ALARM menu.

To make these adjustments, touch the button corresponding to the alarm to be adjusted and it will be selected (the color will be modified), allowing to change its value using the turns and confirms button. To confirm the set value, press the button corresponding to the alarm again or press the turn and confirm button (ENTER).

In this menu it is also possible to set the maximum allowed apnea time of the patient, which will determine the start of backup ventilation (backup).

There is also the option of automatic adjustment of the alarms, to enable it is necessary that the ventilator is not in STAND BY and that the ventilation is stabilized, aiming for greater patient safety.

6.3.5 Mute alarm button

By pressing this button, the alarms are silenced for the time set in the ADVANCED menu. If a new alarm occurs while the mute button is active, the mute is disabled and the alarm sounds.

6.3.6 Manual cycle button

Manually trigger an inspiratory cycle, depending on the ventilatory mode selected.

6.3.7 Inspiratory hold button

Pressing this button pauses the inspiratory time for the time set in the ADVANCED menu. This function allows the performance of inspiratory suspension maneuvers, used in the case of chest X-rays. During the execution of this maneuver, the apnea alarm is not displayed. Only the message "Insp Pause" is displayed.

6.3.8 Expiratory hold button

Pressing this button pauses the Expiratory time for the time set in the ADVANCED menu. This function allows for extended expiration time maneuvers (prolong expiration time). During the execution of this maneuver, the apnea alarm is not displayed. Only the message "Exp Pause" is displayed.

6.3.9 O₂+ button (O₂ flush)

When this button is pressed, an O₂ flush is performed with the concentration and time set in the ADVANCED menu. During this time, the high FiO₂ alarm will be inhibited. This feature can be used for pre- and post-aspiration of airway secretion procedures and is available in all ventilatory modes. Use with an aspiration catheter may be performed in any mode and does not require a specific adjustment.

6.3.10 Nebulizer / TGI button

By pressing this button, nebulization or TGI is performed according to the setting in the RESOURCES menu.

Nebulization is activated during inspiration, while TGI is activated during expiration. During nebulization and TGI activation, delivered volume, pressure, and FiO₂ are not affected.

6.3.11 Graphic freeze button

When you press this button, the graphics are frozen.

6.3.12 Menu access area

Pressing this button displays the following menus: Layout, Resources, Maneuver, Trend, Calibration, Advanced, Status and System.

6.3.12.1 Layout

Pressing this button displays the available graphic layouts: 2 waveforms, big numbers, monitor, 3 waveforms, 5 waveforms, lung, 2 loops and trend (see chapter 6.4.1.3).

2 waveforms

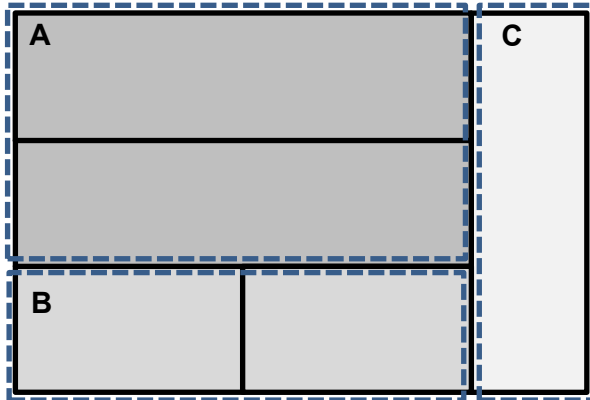

3 waveforms

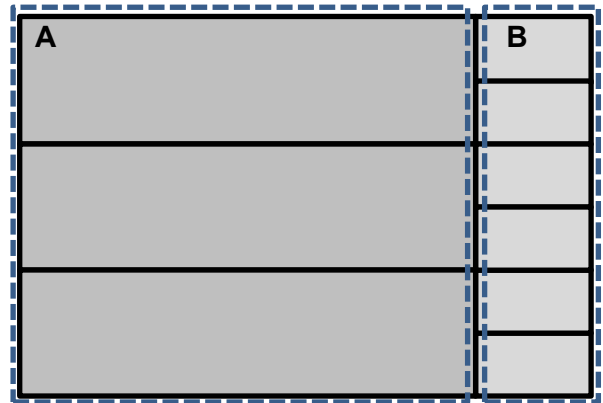

big numbers

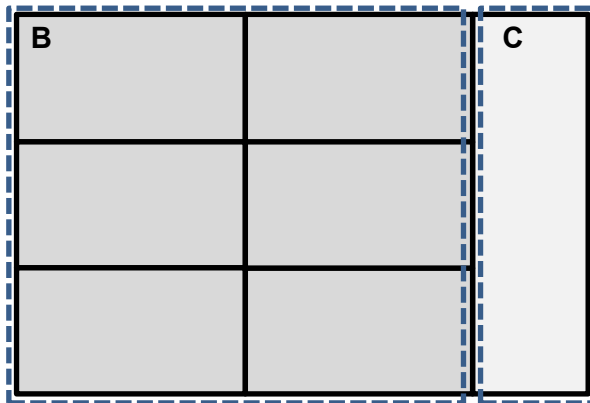

5 waveforms

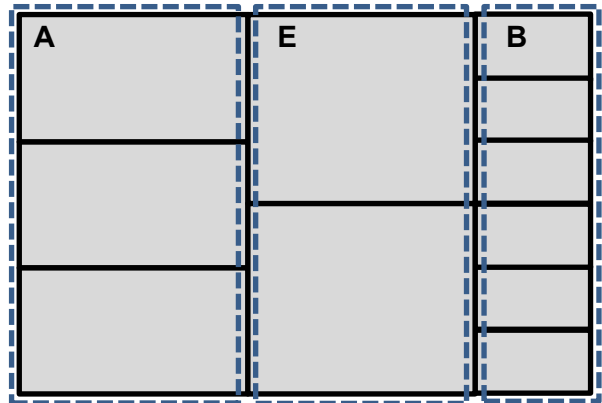

monitor

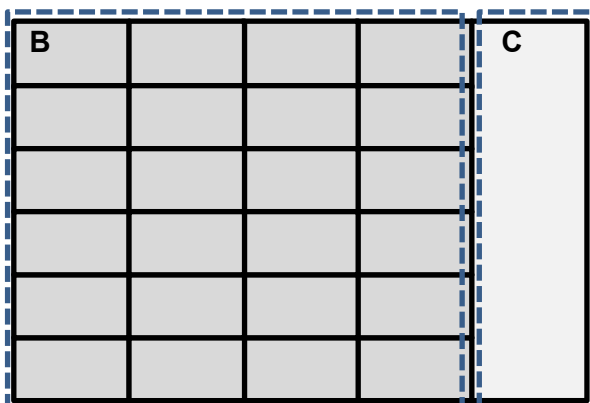

lung

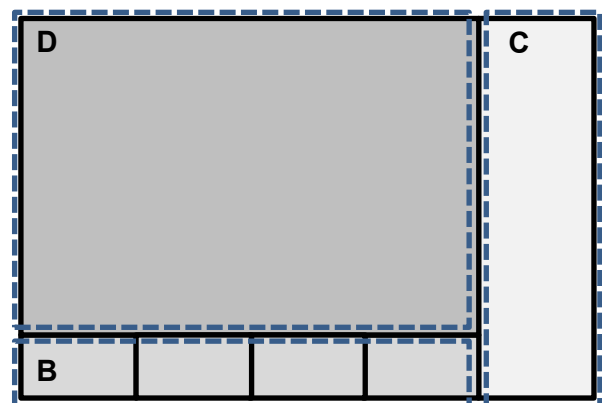

2 loops

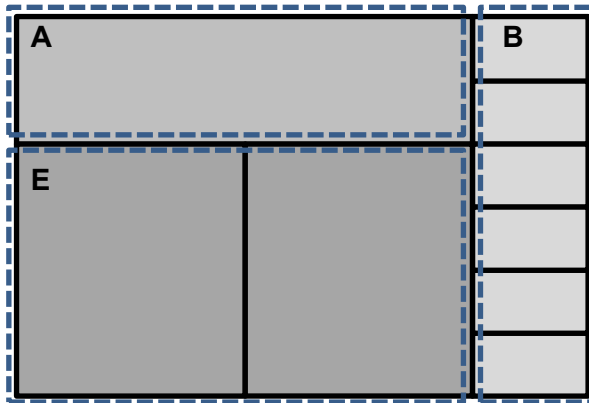

Legend:

A – Graphics: SpO₂, CO₂, CO₂(%), Flow, Volume, Pressure

B – Monitored parameters: SpO₂, Pulse, Perf, PVI, EtCO₂, WOBI(L), iCO₂, Ppeak, PEEP, Rrate, O₂, Vte, MV, Vti, Pplat, Pmean, I:E, Ti, Te, Vte sp, MV sp, RR sp, Ti/Ttot, RSBi, WOBI(min), Ri, Re, C dyn, C stat, Leakage (%), Leakage (F), Tc, E, iPEEP, O₂ consumption, Driving Pressure, Stress Index, Flow peak insp, Flow peak exp, vol/weight insp, vol/weight exp, C20/C, VDaw, VDaw/VTE, Vtalv, V'alv, VeCO₂, VCO₂, V'CO₂, PACO₂, PETCO₂, ViCO₂, FetCO₂, slopeCO₂

C – Bargraph

D – Lung

E – Loops: PxV, PxF, VxF, VxCO₂, VxFCO₂

6.3.12.1.1 Lung Layout

Aiming to optimize, protect and individualize pulmonary ventilation, focusing on the patient and his pathology, this layout was developed for protective monitoring, allowing the operator to have access to continuous evaluation to define the best ventilation strategy.

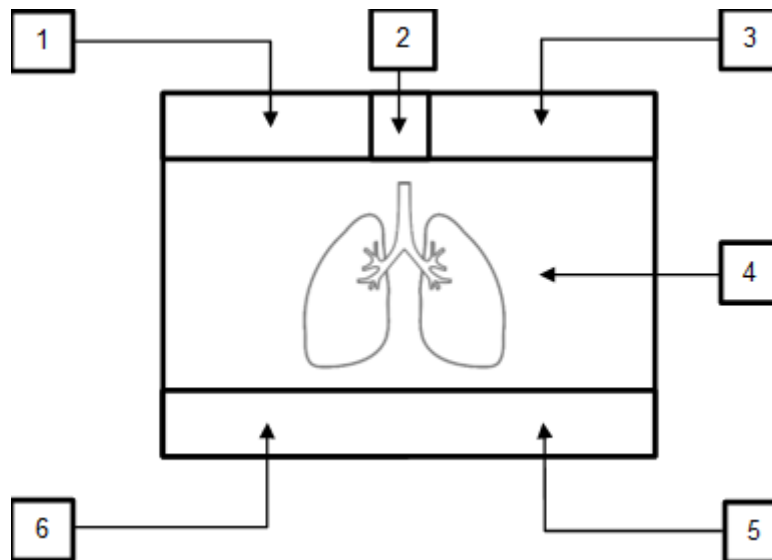

In this layout, the operator can define the limits for protective ventilation. For this, the operator must adjust the minimum (1) and maximum (3) volume/weight. In (1) the minimum volume calculated according to the adjusted minimum volume/weight is displayed and in (3) the maximum volume calculated in accordance with the adjusted maximum volume/weight.

In (2) the monitored volume and the calculated volume/weight based on the patient's adjusted weight and the monitored volume are displayed.

In (4) the lung is displayed, which alternates the tonality to represent four states: empty (a), insufficient volume (b), ideal volume (c) and excessive volume (d), allowing the operator to see if the ventilation is ideal or not for the patient according to the minimum and maximum volumes calculated in (1) and (3). If the monitored volume is below the minimum volume calculated in (1), the lung will be represented in gray tone, indicating insufficient volume (b). If the monitored volume is between the minimum (1) and maximum (3) limits, the lung will be represented completely filled in white, indicating ideal volume (c). If the monitored volume exceeds the maximum volume calculated in (3), the lung will be represented as fully filled and an overflow will flash in white, indicating excessive volume (d). During expiration, the lung will be represented in black, indicating an empty state (a).

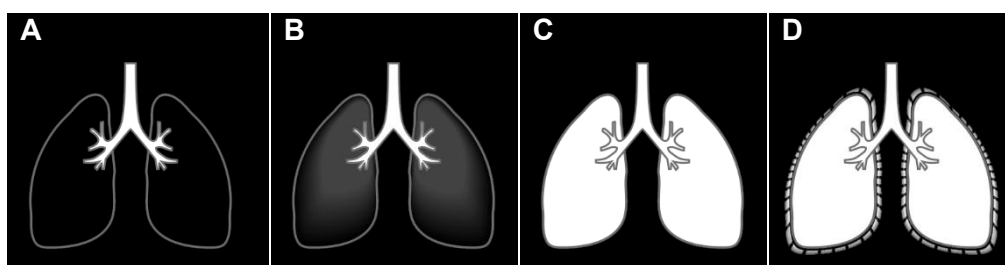

Executing an inspiratory pause, static compliance (6) and inspiratory resistance (5) are calculated, allowing the operator to visualize the evolution of the patient's clinical condition.

6.3.12.2 Resources

Pressing this button displays the following resources: NIV, External Auxiliary Pressure, Tube Compensation, Sigh, Neb-TGI, Humidifier and activation/deactivation of the oxygen monitor.



WARNING

- *The oxygen monitor may be disabled. In this case, ensure that an alternative means of oxygen monitoring is available and operational.*
- *To ensure proper operation of the oxygen monitor, replace the worn oxygen sensor or use an external monitor that meets ISO 80601-2-55.*

6.3.12.2.1 Noninvasive Ventilation (NIV)

Noninvasive ventilation (NIV) refers to the application of ventilatory support without invasive methods of the airways, such as orotracheal intubation or tracheostomy. Nasal or orinasal masks are the most frequently used interfaces for the application of NIV in a hospital environment.

When applying NIV in pressure-controlled modes, the pressure value must not be set to 0 (ZERO) and the pressure drop cycle trigger must be active. Flow trigger remains off.

In NIV the ventilator automatically compensates for higher leakage flows and ignores high minute volume, high current tidal and flow sensor checks.

NIV is available for all ventilatory modes.



WARNING

- *The default values are only an initial reference.*
- *Readjust ventilation parameters as required by the patient.*
- *Use the appropriate mask for each type of patient to avoid excessive leakage.*
- *The exhaled volume of the PATIENT may differ from the volume exhaled measured due*

to leaks in the mask.

For non-invasive ventilation, use expiratory carbon dioxide concentration measuring devices in accordance with ISO 80601-2-55 (See Chapter 11 -

6.4 Internal volume of the breathing circuit components

Table 61 - Internal volume of the breathing circuit components

internal volume	
Trachea 22mm x 1.20 m autoclavable 22f+22f	407,8 mL
Y adult 22mm autoclavable with straight thermometer	18,7 mL
Trachea 15mm x 1.20 m autoclavable 15f+22f	179,5 mL
Intermediate 15m+15m for autoclavable infant breathing circuit	3,6 mL
Pediatric's Y 15mm autoclavable without thermometer 90	16,9 mL
Airway adapter	9,0 mL
Autoclavable adult flow sensor	8,4 mL
Autoclavable infant flow sensor	8,0 mL
Autoclavable neonatal flow sensor	7,7 mL

- **IRMA CO₂ Sensor (optional).**

Observation

- *Flow triggering is disabled during noninvasive ventilation.*
- *Controlled or support pressure (ΔPS) is a value above PEEP and can be adjusted between + 5 cmH₂O and P_{MAX}.*
- *The continuous flow, which apparently 'leaks' through the expiratory valve is normal and serves to reduce the response time of the patient's ventilation control system.*

6.4.1.1.1 External Auxiliary pressure

On the ventilator's front panel, there is a channel for external auxiliary pressure measurement. To use this channel, connect one end of a suitable tube to the auxiliary pressure nozzle (P.AUXILIARY) and the other end to the pressure channel you wish to measure.

It is possible to use this feature with an esophageal balloon or to obtain the pressure of the carina, among other forms.

Activating this option will draw a new pressure curve on the screen with its instantaneous values. The patient's pressure curve continues to be drawn normally.

6.4.1.1.2 Tube compensation

The main purpose of this feature is to compensate the work imposed on the patient by the endotracheal tube.



WARNING

- ***Wrong selection of the endotracheal tube type or gauge can cause injury to the patient.***

In the Tube Compensation window, select the intubation mode and then adjust the endotracheal diameter and compensation percentage.

After making sure that the adjustment is appropriate to the patient, close the setup window and activate the tube compensation.

By activating this option, a new patient pressure curve will be drawn, with its instantaneous values.

This pressure value is estimated based on algorithms that consider the pipe diameter and the percentage of compensation.

The patient's pressure curve, read by the equipment, remains traced and usually tends to be greater than the estimated pressure.

6.4.1.2 Maneuver

The Maneuver menu is available for all patients, except for neonatal patients. This menu basically provides some processes that aid diagnosis, providing data related to the patient's respiratory mechanics.

6.4.1.2.1 P0.1

The P0.1 index can be considered as the pressure drop, below the baseline pressure, that is generated by the patient's inspiratory effort and measured in the first 100 ms of the onset of the inspiratory phase.

As soon as the maneuver is started, the ventilator will step in spontaneously to identify the inspiratory efforts of the patient.

Whenever a cycle is triggered by patient inspiratory effort, the ventilator will calculate P0.1 and display it in the table on the top panel to the left of the chart.

6.4.1.2.2 *Slow Vital Capacity*

A slow vital capacity is the capacity of expiration after a maximum inspiration by the patient and serves as parameter for the evaluation of its ventilatory reserve.

To obtain this parameter, it is necessary that the patient is aware, since their collaboration is paramount.

To perform the maneuver, the ventilator will enter CPAP mode, without pressure support (delta PS = 0).

The patient should then perform successive breaths, extending the inspiratory phase to the maximum, and then exhale slowly, to the maximum extent possible.

6.4.1.2.3 *P/V Flex*

The inflection points of the PV curve (pressure x volume) can be used to obtain the most suitable adjustment values for PEEP and plateau pressure.

Through this feature, the lower and upper inflection points are obtained, the first being the basis for determining the optimal level of PEEP, while the second serves as a parameter for the appropriate maximum pressure and volume level, preventing pulmonary hyperdistention.

For this procedure, the patient should be intubated and without exerting respiratory efforts.

Initially, the user shall adjust the appropriate pressure, volume and flow values to the patient and then press START.

The equipment will provide adjustable constant flow and will pass instantaneous pressure and volume monitoring.

As soon as one of the monitored parameters is reached, the flow is reset, and the ventilator will cycle again normally.

6.4.1.2.4 *Pi Max*

The Pi Max or NIF (negative inspiratory force) is only available for spontaneous modalities and is used to assess inspiratory muscle strength during the weaning process of mechanical ventilation.

Before beginning the maneuver, orient the patient to make the maximum inspiratory effort possible as soon as it is requested.

For this maneuver it is necessary to keep the START button pressed during the entire process.

Once the maneuver is initiated, the PEEP value will be temporarily reset, and the inspiratory branch occlusion will occur.

The negative pressure values relative to the patient's inspiratory effort will be measured to the limit of -60 cmH₂O.

The best value reached will always be displayed in the table to the left of the pressure chart, i.e. the largest pressure drops identified.

6.4.1.2.5 *Gas Trapping Volume*

The trapped volume is only available for assisted-controlled modes.

An unwanted volume of air may eventually become trapped in the lungs in cases of pulmonary hyperinflation or when the interval between breaths is not enough for complete patient expiration to re-establish the balance of the respiratory system. Most notably, when the presence of intrinsic PEEP is detected.

To accomplish this procedure, it is ideal that the patient does not exert respiratory efforts. Therefore, it is recommended that the operator advises the patient if the patient is conscious.

To perform the maneuver, simply press START and then, with each cycle, the ventilator will compare the target volume value (desired) and the total volume value reached.

6.4.1.3 Trend

When pressing this button, the records of the last hours of ventilation will be displayed. Browsing through the pages (6.3.12.4.5) it is possible to view up to 240 hours of logs (up to 432000 events). The trend is presented in the following layout:

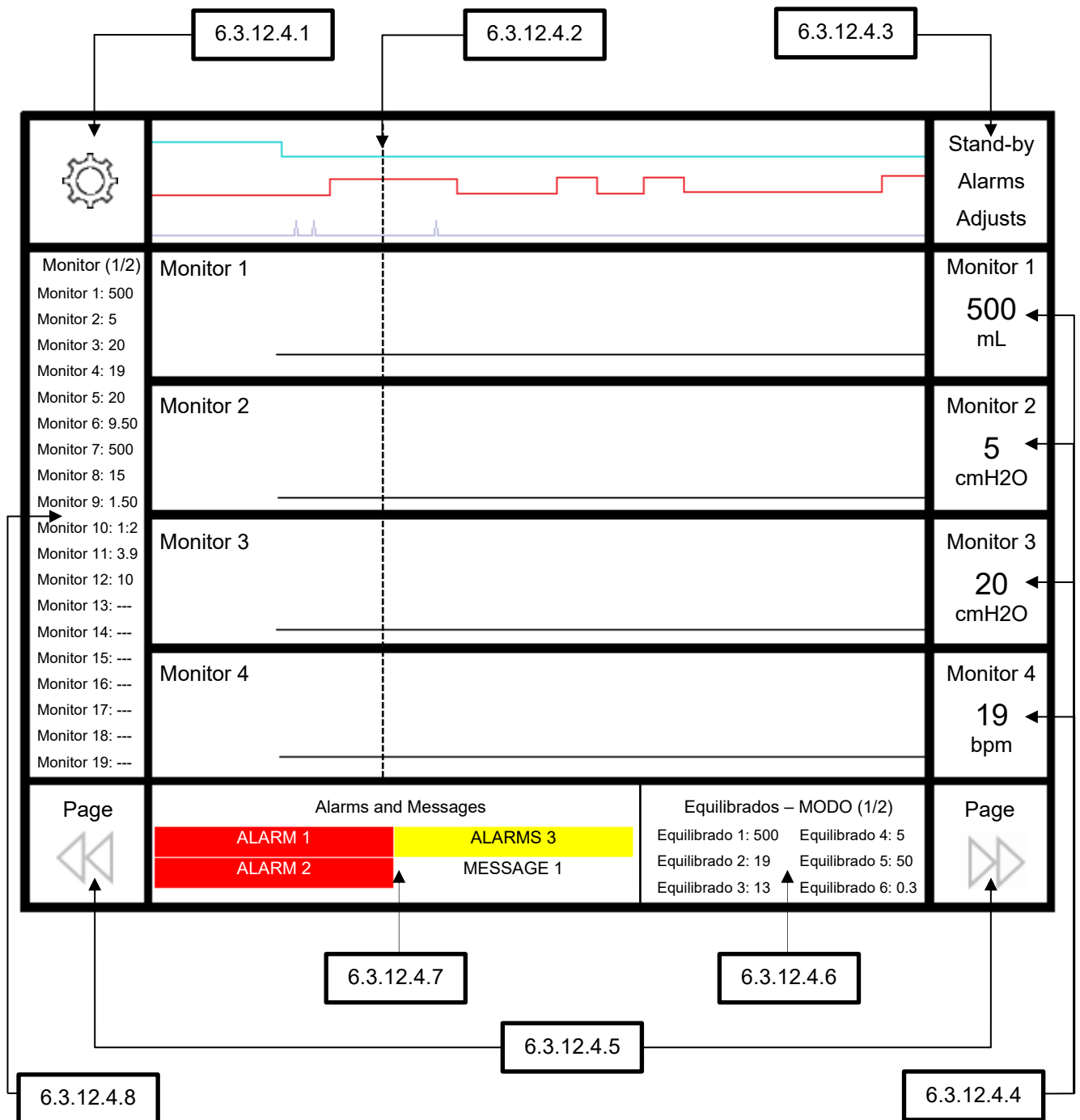

In this example, in the position where the time line is, the ventilator was cycling with the settings shown in 6.3.12.4.6, with the occurrence of three alarms simultaneously and a message displayed in 6.3.12.4.7, with two alarms of high priority, a medium priority alarm and message and the monitoring of that instant displayed in 6.3.12.4.4 and 6.3.12.4.8.

6.4.1.3.1 **Configure trend**

This menu allows you to configure the trend data visualization interval, adjustable from 2 seconds to 16 minutes.

6.4.1.3.2 **Cursor**

This cursor allows navigation through the time line that is shown on the current page, navigable through the tactile screen or through the spin confirmation button. To browse the trend, see the closing time and the time at the top.

6.4.1.3.3 **Events**

This area displays wait events, alarms, and settings on the timeline. The occurrence of events is represented by the change in position of the line, where the line at level 0 indicates that there were no events and the line at level 1 indicates the occurrence of events, as exemplified below:

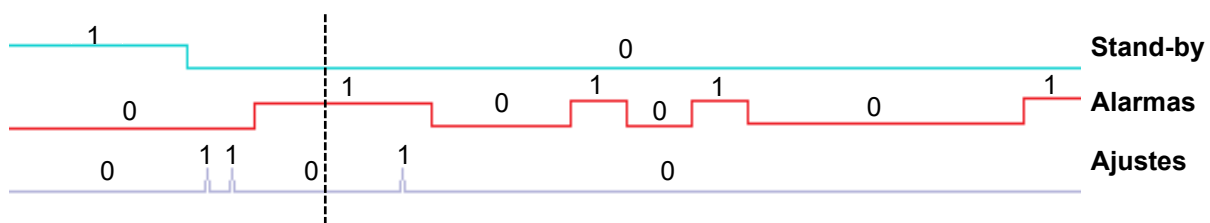

In the example above, 1 indicates that events have occurred and 0 indicates that no events have occurred. In the Stand-by line, 1 indicates that the fan is in stand-by and 0 indicates that it is cycling (not in stand-by). In the alarm line, 0 indicates that it has not occurred and 1 indicates that alarms or messages have occurred. In the settings line, 0 indicates that there are no settings and 1 indicates that some parameter has been set.

So, in the (dashed) timeline, the fan is cycling, an alarm is occurring, and no parameter has been changed at that time.

6.4.1.3.4 **Monitored**

In these menus it is possible to view all the monitors, configuring 4 parameters to be viewed on the timeline at the same time. By moving the timeline with the cursor, it is possible to observe the variation of the monitored parameter.

6.4.1.3.5 Page

With these buttons, it is possible to move forward and backward in time through all the trend pages. The forward and backward direction in time should be based on the date and time displayed at the top of the trend.

6.4.1.3.6 Balancing

In this area, it is possible to see the mode setting at the time the timeline is positioned. Some modes have more than one setup page. In these modes, to view the other pages, click the adjusted area to go to the next page.

6.4.1.3.7 Alarms and messages

In this area, it is possible to view the alarms and messages at the time the timeline is positioned. When more than one alarm occurs at the time the timeline is placed, all alarms will be displayed in this area.

6.4.1.3.8 Monitor

In this area it is possible to visualize all the monitored parameters at the moment of positioning the time line. To view all monitored parameters, click on the monitor area to go to the next page.

6.4.1.4 Calibration

Pressing this button displays the available calibrations: O₂, CO₂ and touch. To perform the calibration, put the equipment in Standby mode and select the item you want to calibrate.

It is recommended to calibrate some components before use in the following situations:

6.4.1.4.1 O₂ cell (galvanic cell only)

- Cell replacement.
- The monitored concentration values (FiO₂) do not seem correct.
- The lower and upper limits do not reach 21 and 100% O₂, respectively.
- Change of patient.

Observations

- *To access the calibration screen, press the CALIBRATION button on the ventilator home screen.*

-
- *It is not necessary to dispose calibration gas.*
-

6.4.1.5 Advanced

Pressing this button displays the following settings: O₂+, ins and exp hold, keypad lock, mute alarm, controlled volume adjustment, flow sensor, and pressure unit.

6.4.2 Lock Button

Accidental change protection system. Locks or unlocks the touch screen. When the display commands are locked, press this key to unlock them IMMEDIATELY.

To lock again, simply press this key once or wait for some time without touching the screen and the screen will lock automatically, the time it takes for the screen to lock is set in the general settings.

The time lock can be turned off in the advanced menu.

6.4.3 Stand by button

Pressing this button turns the standby mode on or off. In standby mode, alarms are interrupted, and ventilation is paused. For security reasons, to activate or deactivate the standby mode, press the button for 2 seconds.

6.4.4 Bargraph or monitored parameters area

According to the layout, the pressure bargraph or 6 monitored parameters will be displayed.

6.4.5 Graphics area

In this area the adjusted graphics layout is displayed. The available graphics are:

- Pressure x Time Curve
- Flow x Time Curve
- Volume x Time Curve
- Pressure x Volume Loop
- Volume x Flow Loop
- Pressure x Flow Loop
- Volume x CO₂ Loop
- Volume x FCO₂ Loop

- CO₂ x Time curve ⁽¹⁾
- SpO₂ x Time curve ⁽¹⁾
- CO₂(%) curve ⁽¹⁾
- Instant pressure bar graph with numerical indicator of peak, plateau or instantaneous pressure

(1) This graph option is only available when an external sensor (oximeter or capnograph) is connected.

The monitored parameter display option is still available, where up to 24 of the 36 monitored parameters are displayed.

6.4.6 Print Screen

By clicking on this button, a screen capture will be taken, which can be exported via flashdrive.

6.4.7 Ventilation Mode Setting Area

When pressing this button, the available ventilation mode options are displayed.

6.4.7.1 Ventilatory modes available

Table 5 - Ventilatory modes

Mode	Sistematic code according to ISO 19223	Backup	Backup Mode ⁽¹⁾	
			Neo	Ped and Adu
VCV	CMV-VC A/C-VC	✓	—	Auto
PCV	CMV-PC A/C-PC	✓	Auto	Auto
PRVC	CMV-vtPC A/C-vtPC	✓	—	Auto
PLV	CMV-PC A/C-PC	✓	Auto	—
V-SIMV	SIMV-VCIPS	✓	—	Auto
P-SIMV	SIMV-PCIPS	✓	Auto	Auto
CPAP/PS	CSV-PS CPAP	✓	Adjustable PLV + Auto	Adjustable VCV and PCV + Auto

Mode	Sistematic code according to ISO 19223	Backup	Backup Mode ⁽¹⁾	
			Neo	Ped and Adu
DualPAP	SIMV-PC{S}\PS(x2)	✓	Adjustable PLV + Auto	Adjustable VCV and PCV + Auto
APRV	SIMV-PC{S}\PS(x2)	✓	Adjustable PLV + Auto	Adjustable VCV and PCV + Auto
MMV	SIMV-VC\PS	✓	—	Adjustable VCV and PCV + Auto
VS	CSV-vtPS	✓	—	Adjustable PRVC + Auto
Nasal CPAP	CSV-PS CPAP	✓	Adjustable PLV + Auto	—
NIV	CSV-PS	✓	—	Adjustable VCV and PCV + Auto
VG	CMV-vtPC A/C-vtPC	✓	Auto	—
O ₂ Therapy	—	X	—	—
PRVC-SIMV	SIMV-vtPC	✓	—	Auto
MASV	—	✓	—	Auto

Observations

- For modes in which the backup is set to "Auto", whenever the set apnea time is reached, the ventilator starts a ventilatory cycle, this configuration is based on the settings of the current ventilator mode.
- When the equipment enter in backup mode, it is necessary for the patient to make an effort to return to the set ventilation mode.

6.4.7.2 Adjusting ventilatory modes

To change or reconfigure a ventilatory mode, simply touch the button that indicates the active mode in the upper right corner of the screen. This button will change color and then the ventilator modes setting screen will be loaded.

Observations

- *The ventilatory modes available will be determined according to the ventilator model and the selected patient (see **Table 5**).*

To select a ventilatory mode, simply touch the tab with the acronym of the desired mode. All the adjustable parameters required for this ventilatory mode, including those for backup ventilation, will be displayed.

Observations

- *Adjustment of backup ventilation parameters (backup) is only available in spontaneous ventilatory modes. In the other modes, the backup ventilation is automatic and considers the parameters adjusted for the ventilatory mode itself.*
- *When the operator sets pressure or flow trigger, the controlled modes (VCV, PCV, PRVC and PLV) will be monitored. In this case, such information will be displayed on the active mode button.*

After adjusting the parameters, for them to be activated, it is necessary to press the CONFIRM button.

To cancel the settings and to continue with the previous settings, including the ventilatory mode, simply press the CANCEL button. This way the ventilator will ignore the settings made on this screen and will return to the main screen.

ATTENTION

- *If the new value is not confirmed, it will be discarded after the screen lock time.*

6.4.8 Parameter setting area

In this area, parameter settings for the current mode can be made.

6.5 Calibrations

It is recommended to calibrate some components before use in the following situations:

6.5.1 Distal Flow Sensor (Envitec or reusable)

- Replacement of the distal flow sensor (Envitec or reusable)
- Active alarm with message "CHECK FLOW SENSOR".

6.5.2 Integrated valve

- Replacement of integrated valve;
- Replacing the diaphragm;
- Incorrect control of PEEP;
- Excessive leakage.

6.5.3 O₂ cell (galvanic cell only)

- Cell replacement;
- The monitored concentration values (FiO₂) do not seem correct;
- The lower and upper limits do not reach 21 and 100% O₂, respectively;
- Change of patient.

Observation

- *To access the calibration screen, access the menu on the ventilation screen or restricted on the ventilator home screen.*

6.6 Automatic compensation of the respiratory circuit

For volumes and pressures, delivered and monitored, leaks are always considered because of circuit compliance and resistance.

In the event of failure of the compliance and resistance autotest, the efficiency of the compensations is maintained if the circuit used is compatible with the values defined in Table 43 - Expiratory and inspiratory branch resistance specifications and Table 44 - Respiratory circuit compliance specification.

7 Troubleshooting

In this topic, the main occurrences and the possible solutions are presented.

Occurrence	Probable causes	Proposed solution
Low battery alarm	Depletion of internal battery charge.	<i>Connect the equipment to the electrical outlet or provide other means of ventilatory support.</i>
	Internal battery charging system failure, even with power.	<i>Contact technical assistance for service.</i>
Disconnect alarm	Disconnection in the respiratory circuit.	<i>Locate the disconnect point and firmly connect all parts of the breathing circuit.</i>
	Lack of inspiratory flow.	<i>Check for inspiratory flow and increase if necessary.</i>
	Alteration of the patient's respiratory mechanics.	<i>Establish adequate parameters for ventilatory support.</i>
	Integrated valve diaphragm placed incorrectly or damaged.	<i>Replace or return the diaphragm to the correct position.</i>
	Failure of the electronic control system.	<i>Contact technical assistance for service.</i>
Communication failure alarm	Electronic fault.	<i>Contact technical assistance for service.</i>
High pressure alarm	Alteration of the patient's respiratory mechanics.	<i>Establish adequate parameters for ventilatory support.</i>
	Obstruction in the expiratory branch of the respiratory circuit or in the integrated valve.	<i>Clear the circuit of any obstruction or reposition the integrated valve diaphragm.</i>
	Obstruction of the patient's airway.	<i>Unclog or aspirate the patient's airway.</i>
	Monitored inspiratory pressure is higher than expected.	<i>Check the inspiratory pressure (absolute) setting, which is the sum of the controlled (relative) pressure and PEEP.</i>
	Tube Compensation is on.	<i>Turn off or reconfigure tube compensation.</i>
Low pressure alarm	Alteration of the patient's respiratory mechanics.	<i>Establish adequate parameters for ventilatory support.</i>
	Excessive leakage in the respiratory circuit.	<i>Locate the leak and correct.</i>
Electrical network alarm	Disconnected power cord.	<i>Properly connect the power cord to the equipment or in case of in-hospital transport, check that there is enough battery power.</i>
	Power failure.	<i>Try to reestablish a power source.</i>
Inoperable Alarms	Electronic failure.	<i>Contact technical assistance for service.</i>
Incorrect control of PEEP	Calibration of the integrated valve.	<i>Restart the equipment and calibrate the integrated valve.</i>

Occurrence	Probable causes	Proposed solution
Curves and / or ventilation loops appear with inadequate scaling or tracing speed.	Automatic adjustment of scales or graphic speed off.	<i>Tap on the graph screen and select the automatic adjustment in the corresponding window.</i>
Curves and trend values do not appear or are incorrect.	Failed to set the system clock.	<i>Contact technical assistance for service.</i>
Equipment does not start ventilation	Equipment in standby mode.	<i>Press the STAND BY button for 2 seconds to remove the ventilator from standby mode.</i>
Proportional valve test failure.	Gas network pressure below the minimum limit.	<i>Check and readjust the network pressure to the specified range.</i>
Distal flow sensor test failed.	The respiratory circuit output was not obstructed.	<i>Restart the ventilator and redo the autotest with the respiratory circuit obstructed.</i>
Proximal flow sensor test failure and resistance.	Respiratory circuit output was not open.	<i>Restart the ventilator and redo the autotest remembering to open the respiratory circuit when prompted.</i>
Integrated valve test failure	The respiratory circuit output was not obstructed.	<i>Restart the ventilator and redo the autotest with the respiratory circuit obstructed.</i>
	Integrated valve diaphragm	<i>Reposition the integrated valve diaphragm, restart the equipment, and redo the autotest.</i>
No maneuvers available	Neonatal patient selected.	<i>Maneuvers available only for pediatric and adult patients.</i>
	Equipment in standby mode.	<i>Press the STAND BY button for 2 seconds to remove the ventilator from standby mode.</i>
	Ventilatory mode not compatible with the maneuver.	<i>Set an appropriate ventilator mode according to the desired maneuver.</i>
It is not possible to activate automatic alarm adjustment.	Equipment in standby mode.	<i>Automatic adjustment of alarms can only be calculated with the ventilator cycling. Press the STAND BY button for 2 seconds to remove the ventilator from standby mode, wait for the ventilation to stabilize and then activate the automatic adjustment.</i>
Events cannot be viewed.	There is still no loaded trend curve.	<i>Select a trend range before attempting to query the events.</i>
The setting of the parameters returns to the previous value.	Adjustment was not confirmed.	<i>Confirm the setting by pressing the turn and confirm button or by tapping on the parameter that has been reset.</i>
Inspiratory or expiratory hold do not end as soon as the respective button is released.	The minimum set pause time is longer than desired.	<i>Press the ADVANCED MENU button and reset the minimum pause time.</i>
Alarm sound is off	Alarm silence time activated.	<i>Turn off the alarm silence.</i>
	Electronic failure.	<i>Contact technical assistance for service.</i>
Backup ventilation is not activated.	Apnea time alarm off.	<i>Set an interval for the apnea alarm.</i>



WARNING

- **Never operate the equipment if a problem cannot be solved.**

8 Cleaning, Disinfection and Sterilization

It is important to establish a routine for the cleaning, disinfection or sterilization of the equipment and its components.

The following are the main ways of cleaning, disinfecting or sterilizing according to the characteristics of each component and the equipment.



WARNING

- *Before use, perform the cleaning, disinfection and sterilization procedures as specified in this manual.*

8.1 Fleximag Max external parts, hoses, AC mains cable

External ventilator surfaces of Fleximag Max shall be cleaned with a clean, soft cloth moistened with the enzymatic detergent.

8.1.1 Cleaning

External parts of the Fleximag Max ventilator, hoses and AC mains cable should be cleaned with a soft clean cloth dampened with enzymatic detergent.



Observations

- *Make sure that the equipment is turned off to perform cleaning of the display.*
- *Make sure that no residue builds up in the equipment connections.*
- *For cleaning, do not use non-compatible polymer products.*

8.1.2 Disinfection

The external parts of the Fleximag Max ventilator, hoses and AC mains cable must be disinfected using a clean soft cloth with 70% ethanol solution.

8.2 Breathing circuit, PROXIMAL flow sensor, reusable distal flow sensor, silicone line, diaphragm and integrated valve

8.2.1 Cleaning

- a) Always use potable water for this procedure;
- b) Use neutral and enzymatic detergent. Dilution should be performed as recommended by the manufacturer.
- c) Immerse the entire body of the flow sensor and the silicone line in the detergent solution, keeping the solution in contact with the accessories for at least 3 minutes;
- d) The external parts of the parts should be cleaned with a clean, soft cloth moistened with the enzymatic detergent. The internal parts must be cleaned by immersion.

8.2.1.1 Rinse

- a) Always use potable water for rinsing;
- b) Thoroughly rinse the external surface of the accessories with potable water.
- c) Rinse the internal surface by injecting potable water under pressure at least 5 times.



ATTENTION

- ***Do not use for cleaning or disinfection phenol (> 5%), ketones, formaldehyde, hypochlorite, chlorinated hydrocarbonates, aromatic hydrocarbonates, inorganic acids and quaternary ammonium compounds.***
- ***Never use saline solutions, especially sodium hypochlorite (bleach) and saline, disinfectants, hydrogen peroxide for cleaning or rinsing the accessories.***

8.2.1.2 Drying

Drying of the external parts should be done with a clean, soft and dry cloth and the drying of the internal parts should be done so that the solution drains by gravity.

8.2.2 Disinfection

After cleaning, accessories and parts must be disinfected with 70% ethanol. The external parts must be disinfected using a clean cloth moistened with 70% ethanol and the internal parts by immersion.

After disinfection, the external parts must be dried with a clean, dry cloth and the internal parts must be gravity dried.

8.2.3 Sterilization

After cleaning and disinfection, the breathing circuit accessories must be sterilized in an autoclave (135°C for 5 minutes).

Table 6 – Sterilizable accessories

Description	Sterilization cycles (lifetime)
PROXIMAL flow sensor	50
Silicone Lines	50
Integrated valve	50
Integrated valve diaphragm	50
Breathing circuit	50
Reusable distal flow sensor	50

8.3 Distal flow sensor (Envitec SpiroQuant A+)

It is recommended to disinfect the flow sensor before use. For disinfection:

1. Disconnect the distal sensor from the exhalation valve and the connector cable and wait 30 minutes.
2. Immerse the sensor in 70% ethanol solution for 1 hour
3. Allow to dry naturally for 30 minutes in the environment before reassembly.



ATTENTION

- *The Envitec distal flow sensor must not be sterilized by steam.*
- *For the internal disinfection of Envitec DISTAL flow sensor, do not use tools that may generate mechanical forces, such as air or water jet, at the risk of damaging the filament.*
- *Drying of DISTAL flow sensor should occur naturally in ambient air, so avoid the use of compressed air or dryer.*
- *If there is a possibility of the sensor remain infected, replace it promptly.*

8.4 IRMA CO₂ sensor

The IRMA CO₂ sensor may be disinfected with a cloth moistened with 70% ethanol.



ATTENTION

- *The airways adapters IRMA CO₂ sensor are unsterile supplies, so the steam sterilization can damage these accessories.*
 - *The airway adapter should not be reused.*
 - *The reuse of a disposable adapter may cause cross infection.*
 - *Never sterilize or immerse the IRMA CO₂ sensor in liquid.*
-

8.5 Oximetry sensor (oximeter)

The oximetry sensor must be cleaned and disinfected with a cloth moistened with 70% ethanol.



ATTENTION

- **Caution at cleaning/ disinfection:**
 - *Do not steam-sterilize, pressure-sterilize, or gas-sterilize the Oximeter*
 - *Do not wet up or dive the monitor into any liquid.*
 - *Use cleaning solutions with moderation. Excess solution may run into the monitor and cause internal damages to the components.*
 - *Do not touch, press, or scrub the display panel with abrasive cleaning components, brushes, cleaning instruments, and do not leave it in contact with anything to scratch the panel.*
 - *Do not use solutions derived by petroleum or acetones, or other abrasive solvents to clean the oximeter. These substances attack the device's materials and may result in its failure.*
-

8.6 Important Advices



WARNING

- *Prior to first use, the equipment and its components shall be cleaned, disinfected and sterilized as specified.*
 - *All parts of Magnamed ventilators that come in contact with patient fluids (e.g. breathing circuit) and that are potentially contaminated, are called semi-critical, and*
-

shall be endure a high-level disinfection or sterilization process before disposal (at the end of their useful lives) or before it is sent in for maintenance.

- *When sending the ventilator for maintenance or repair, observe the process of disinfection RIGOROUSLY.*
 - *Do not immerse the sensor in water, solvents, or cleaning solution (sensors and connectors are not waterproof). Do not sterilize by irradiation, steam, or corrosion sterilization. See the cleaning instructions in the instructions for use for Masimo LNOP® / LNCS® reusable sensors.*
 - *Do not use damaged patient cables.*
-



ATTENTION

- *Removable Magnamed accessories and components that exhibit damage or signs of wear should be replaced to prevent use.*
 - *Packaging of non-sterile devices (breathing circuits, expiratory valves, and connectors) is designed to keep these products at the proper cleaning level to be sterilized prior to use and to minimize microbial contamination.*
-



Observations

- *Do not use abrasive cleaners.*
 - *Do not use alcohol to clean the plastic parts, except when specified.*
 - *Do not immerse the ventilator in any liquid.*
-

8.7 Processing Methods

Table 7 – Processing methods

Component	Processing method		
	Neutral Enzymatic Detergent	70% Ethanol	Steam Sterilization 135°C for 5 min
Ventilator surface	✓	✓	x
Touch screen	✓	✓	x
Breathing circuit silicone	✓	✓	✓
Silicone pressure line	✓	✓	✓
Integrated valve	✓	✓	✓
Diaphragm	✓	✓	✓
Proximal Flow Sensor (Adu, Inf and Neo)	✓	✓	✓
Reusable Distal Flow Sensor	✓	✓	✓
Envitec flow sensor (heated filament)	x	✓	x
SpO ₂ sensor	x	✓	x
EtCO ₂ Sensor	x	✓	x

9 Preventive maintenance



WARNING

- The symbol  on the ventilator screen indicates that the equipment has entered the preventive maintenance period. For ICU equipment this period is 5,000 hours or 12 months, whichever occurs first.
- Failure to perform maintenance may affect the safety and performance of the ventilator.
- Maintenance shall be performed as indicated by the manufacturer and only by an authorized technician service. The noncompliance will result in loss of warranty and manufacturer's obligations related to the ventilator.
- Schedule preventive maintenance only with the authorized Magnamed Service.
- Before sending the equipment to the service technician, observe the cleaning and disinfection process **RIGOROUSLY**.

9.1 Verifications

The following verifications shall be made daily and whenever the equipment is to be used:

- AC/DC converter power cable integrity;
- Operation of the alarm system, including audio;
- Air/O₂ Filters installed and unobstructed;
- LCD display;
- Batteries charged;
- Touchscreen;
- Turns and confirm Button;
- Correct installation of the respiratory circuit (including the diaphragm of the integrated valve);
- Mesh filter installed.



WARNING

- The daily check must be performed with the ventilator disconnected from the patient.
- The Fleximag Max, its parts and accessories should not be serviced during use.

9.2 Preventive Maintenance Schedule

Magnamed recommends performing preventive maintenance of ICU ventilators with your authorized network throughout the country.

Below spreadsheet with the schedule of maintenance and exchange of preventive parts. If you need more details, contact the MagnaService (Magnamed Technical Assistance).

Table 8 – Preventive maintenance schedule

ITEM	Period									
	5000 h or 1 year	10000 h or 2 years	15000 h or 3 years	20000 h or 4 years	25000 h or 5 years	30000 h or 6 years	35000 h or 7 years	40000 h or 8 years	45000 h or 9 years	50000 h or 10 years
Assessment according to procedures MAGNAMED	X	X	X	X	X	X	X	X	X	
Evaluate replacement of consumables	X	X	X	X	X	X	X	X	X	
LI-ION Battery Pack		X		X		X		X		
O ₂ cell (galvanic)		X		X		X		X		
Disposal of equipment										X

9.3 Consumable items

Table 9 – Consumable items replacement

ITEM	Period
Silicon line	2 years or after 50 hot steam sterilization cycles
Diaphragm	2 years or after 50 hot steam sterilization cycles
Adult proximal flow sensor	5 years or after 50 hot steam sterilization cycles
Pediatric proximal flow sensor	5 years or after 50 hot steam sterilization cycles
Neonatal proximal flow sensor	5 years or after 50 hot steam sterilization cycles
Integrated valve	5 years or after 50 hot steam sterilization cycles
Mesh filter	3 months
Air/O ₂ inlet filter	Replace if it is obstructed
Reusable distal flow sensor	5 years or after 50 hot steam sterilization cycles

9.4 Internal Batteries

These batteries are responsible for maintaining the operation of the equipment even in the absence of electricity and its duration in normal operation is specified in chapter 10.



WARNING

- *For there to be enough battery power during a power outage, it is important that the equipment remains connected to a mains power supply **WHENEVER POSSIBLE**.*



ATTENTION

- *For the capacity of the batteries in normal operation to be full, they shall be replaced as indicated in the technical specification.*
- *Replacement of the internal batteries shall be performed by trained and qualified personnel.*

9.5 Water Collectors with Coalescing Filter





ATTENTION

- *Do not expose the filter container to non-polycarbonate compatible materials.*
- *Replace the filter when it is clogged so that it does not slow down the inlet flow of the equipment.*

To remove accumulated water, simply press the pin found on the bottom of the collector.

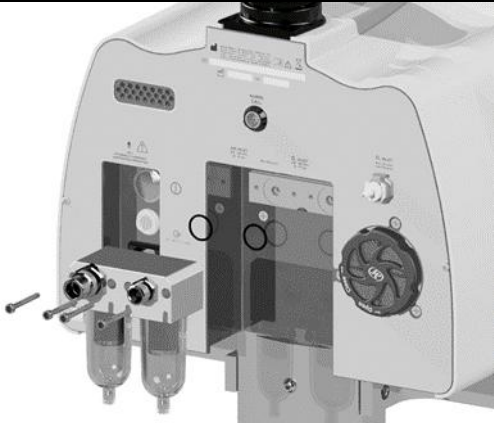
To perform filter replacement, consider the following instructions:

Instruction	Image
Remove the screws with an Allen wrench	

Instruction	Image
Remove the manifold with the O-ring	
Unscrew the filter and thread the new filter	

9.6 Mesh filter

ATTENTION

- *The mesh filter is used to protect the equipment. To protect the patient from bacteria and virus contamination, use the HEPA filter as specified in chapter 10.29.*

The mesh filter is used to protect the equipment from particulate matter in suspension in the environment. To perform filter replacement, consider the following instructions:

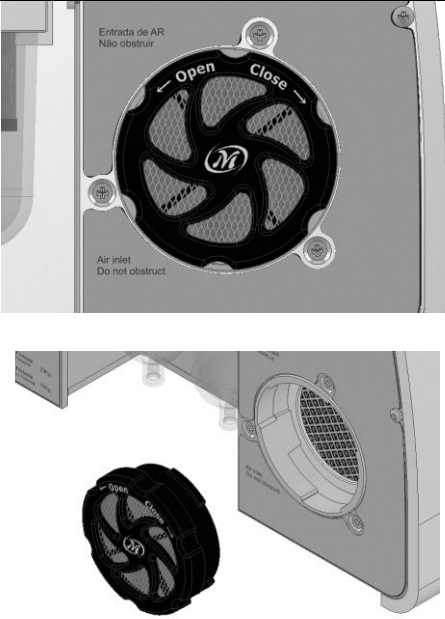
Instruction	Image
<p>Turn the filter to the left side to remove.</p> <p>Introduce a new filter and turn to the right side to close.</p>	

9.7 O₂ Concentration Cell

This ventilator is equipped with O₂ monitoring means for measurements of inspiratory oxygen concentration according to ISO 80601-2-55. This equipment has two ways of measuring the concentration of oxygen:

Galvanic Cell - generates an electric signal proportional to the concentration of oxygen in the gas mixture administered to the patient and the intensity of this electrical signal is due to the chemical reaction. This measuring medium is consumable, and the life of the cell as specified by the original manufacturer is 10,000 hours at 100% O₂, i.e. greater than one year of continuous use. However, we recommend switching during preventive maintenance on a 24-month or 10,000-hour schedule (whichever comes first).

Paramagnetic Cell - generates an electric signal proportional to the concentration of oxygen in the gas mixture administered to the patient and the intensity of this electrical signal is due to the torque created in the magnetic arrangement of the cell. This sensor uses the paramagnetic susceptibility of oxygen that distinguishes it from other gases. This measuring medium is not consumable.



ATTENTION

- *The galvanic cell for measuring the oxygen concentration should be replaced as indicated in chapter 10.21.*
- *Replacement should be performed by trained and qualified personnel.*
- *The galvanic O₂ cell undergoes degradation of less than 1% per month in the*

measurement accuracy.

10 Technical specifications

10.1 Classification

10.1.1 Class I Equipment

According to NBR - IEC - 60601, internally energized, type B for continuous operation. IP31 splash proof equipment.

10.1.2 Protection class of applied parts

Patient circuit and flow sensor type B, oximetry sensor and capnography sensor type BF.

10.1.3 CE – Class IIB

According to Annex IX to Directive 93/42 / EEC, Rule 9 - All therapeutic devices that are active because of their characteristics are likely to provide or exchange energy for the body in a potentially dangerous manner, considering the nature, density and location of energy, in which case they belong to class IIB.

10.1.4 ANVISA – Class III

According to RDC 751/22 - Classification Rule 12 - All active medical devices intended to administer to the human body or to remove drugs, body fluids or other substances from it are classified in class II, unless this is done in a potentially dangerous, taking into account the nature of the substances or the part of the body involved and the mode of application, in which case they are classified in class III.

10.1.5 FDA – Class II

According to the Code of Federal Regulations (CFR), Title 21 - Food and Drugs, Chapter I - Food and Drug Administration, Department of Health and Human Services, subchapter H - medical devices, Part 868 - Anesthesiology Devices, Subpart F - Therapeutic Devices, Sec. 868.5895 Continuous ventilator - A continuous ventilator (respirator) is a device intended to mechanically control or assist patient breathing by delivering a predetermined percentage of oxygen in the breathing gas. Adult, pediatric, and neonatal ventilators are included in Class II.

10.2 Applicable Standards

- **IEC 60601-1:2005/A1:2012 + A2:2020 (EN 60601-1:2006 + A1:2013 + A2:20201) / ABNT NBR IEC 60601-1:2010 / EM1:2016 + EM2:2022** - Medical electrical equipment - Part 1: General requirements for basic safety and essential performance
- **ISO 80601-2-12:2020** - Medical electrical equipment - Part 2-12: Particular requirements for the safety of lung ventilators - Critical care ventilators

-
- **ISO 5359:2014/Amd1:2017** - Anaesthetic and respiratory equipment — Low-pressure hose assemblies for use with medical gases
 - **ABNT NBR IEC 60601-1-2:2017 + Emenda 1: 2020 / IEC 60601-1-2:2014 + A1:2020 / EN IEC 60601-1-2:2015 + A1:2021** - Medical electrical equipment - Part 1-2: General requirements for basic safety and essential performance - Collateral standard: Electromagnetic compatibility - Requirements and tests
 - **IEC 62304:2006 +AMD1:2015 (EN 62304:2006/2008)** - Medical device software - Software life-cycle processes
 - **IEC 60601-1-8 Ed. 2.0 (2006)/A1:2012/A2:2020 / ABNT NBR IEC 60601-1-8:2010+ EM1:2014 + EM2: 2022** - Medical electrical equipment - Part 1-8: General requirements for basic safety and essential performance - Collateral Standard: General requirements, tests and guidance for alarm systems in medical electrical equipment and medical electrical systems
 - **IEC 60601-1-4: 1996/A1:1999 (EN 60601-1-4: 1996/A1: 1999)** - Medical electrical equipment - Part 1-4: General requirements for safety - Collateral standard: Programmable electrical medical systems
 - **IEC 60601-1-6:2010 + AMD1:2013 + AMD2:2020 (EN 60601-1-6:2010 + A1:2013+ A2:2020) / ABNT NBR IEC 60601-1-6:2011 + EM1:2020 + EM2:2022** – Medical electrical equipment - Part 1-6: General requirements for basic safety and essential performance - Collateral standard: Usability
 - **IEC 60601-1-9:2007 + AMD1:2013 + AMD2:2020 (EN IEC 60601-1-9:2008 +A1:2013 + A2:2020) / ABNT NBR IEC 60601-1-9:2010 + EM1:2014 + EM2:2022** – Medical electrical equipment - Part 1-9: General requirements for basic safety and essential performance - Collateral Standard: Requirements for environmentally conscious design
 - **IEC 62366: 2007 (EN 62366:2008)** - Medical devices - Application of usability engineering to medical devices
 - **EN ISO 17665-1:2006** - Sterilization of health care products - Moist heat - Part 1: Requirements for the development, validation and routine control of a sterilization process for medical devices
 - **EN ISO 17664:2004** - Sterilization of medical devices - Information to be provided by the manufacturer for the processing of resterilizable medical devices
 - **EN 1041:2008** - Information supplied by the manufacturer of medical devices
 - **ISO 15223-1: 2016 (EN ISO 15223-1:2016)** - Medical devices - Symbols to be used with medical device labels, labelling and information to be supplied - Part 1: General requirements
 - **ISO 80601-2-61:2017 (EN ISO 80601-2-61:2019) / ABNT NBR ISO 80601-2-61:2022** – Medical electrical equipment: Particular requirements for basic safety and essential performance of pulse ox equipment
 - **ISO 80601-2-55:2018 (EN 80601-2-55: 2018) / ABNT NBR ISO 80601-2-55:2020** - Medical electrical equipment -- Part 2-55: Particular requirements for the basic safety and essential performance of respiratory gas monitors

10.3 Physical and Environmental Specifications

Table 10 - Physical and environmental specifications

Parameter	Specification	Tolerance	Unit
Dimensions and weight (basic unit)			
a. Height	1427	± 5	mm
b. Width	453	± 5	mm
c. Depth (with handle)	544	± 5	mm
d. Weight with pedestal	23	± 0.1	kg
e. Weight without pedestal	16	± 0.1	kg
Operation¹			
a. Temperature	-10 to 50	---	°C
b. Barometric Pressure	600 to 1100	---	hPA
c. Relative air humidity (non-condensing)	15 to 95	---	%
d. Altitude (considering a temperature of 25°C)	-719 to 4570	---	m
Storage¹			
a. Temperature	-20 to 75	---	°C
b. Barometric Pressure	500 to 1200	---	hPA
c. Relative air humidity (non-condensing)	5 to 95	---	%
Lifetime			
Fleximag Max 300 Fleximag Max 500 Fleximag Max 700	10	---	years

¹ Permissible operating and storage conditions for the whole electromedical system.

10.4 Electrical Specifications

10.4.1 Electrical network

Table 11 – Electrical network

Item	Specification	Tolerance	Unit
Electrical Network (50/60Hz)	100 to 240	± 10%	V _{AC}
Maximum power consumption	80	± 10%	VA
AC cable	Equipment side connector: As per IEC 60320 type C13 Plug: As per local legislation. Electrical requirements: Compatible with the electrical supply specifications of each device (Voltage and Current). Confirm the marking of the equipment.		

10.4.2 Batteries

Table 12 - Batteries

Item	Specification	Tolerance	Unit
Internal Batteries Li-Ion 11.8 VDC	4000	± 15%	mAh
Battery life (with full charge and normal use) ⁽¹⁾	240 minutes	± 15%	min
Average time to recharge to full (module in operation) ⁽¹⁾	4.0 hours	± 15%	h

(1) The battery charge should be made at the ambient temperature of 5 to 35 ° C

(2) Adult patient in VCV mode and default parameters.

10.4.3 External DC Power Supply

Table 13 – External DC power supply

3.Item	Specification	Tolerance
Power supply ⁽¹⁾	Voltage: 12 to 15 V _{DC}	± 10%
	Current: 11.5 A	

(1) OPTIONAL external power supply

ATTENTION

- *It is not possible to recharge the internal batteries of the equipment through the external DC power source.*
- *The sole purpose of this input is to allow the equipment to be temporarily powered by a compatible external power source when there are no other alternatives.*
- *When connecting a compatible external source, the equipment will turn on the green LED on the button and the software will change the battery status to “Charging” or “Full”, depending on the measured current value.*
- *In ventilation, before disconnecting an external power source, make sure that there is enough charge in the internal batteries or connect the equipment to the electrical network.*

10.4.4 Connectors

Table 14 - Connectors

Item	Specification
External power supply (network)	Comply with local legislation
External power supply	12-15V external input. Housing connector 3.96mm - 4 pins 180° female Green color
External sensor: capnograph ⁽¹⁾	Redel connector - 5 pin female receptacle Blue color
External sensor: oximeter ⁽¹⁾	Redel connector - 5 pin female receptacle Blue color
RS-232 standard connector (EIA RS-232C)	DB9 female type (on top) Used for maintenance and data transfer services through ARM (Assistance Remote Magnamed) only by authorized and trained Magnamed personnel.
Data output connector (network)	Standard RJ-45 Ethernet Connector Used to send data to an electronic health recorder and distributed alarm system. Use a CAT 5E in accordance with ANSI / TIA / EIA-568 or higher with a maximum length of 3 meters to connect the ventilator network port.
Video output connector	Standard connector HDMI intended for non-clinical use
Standard USB connector	Used to transfer print screen, trends, logs and recordings to an external USB flash memory storage device ("flash drive"). It can also be used to software update, only authorized by Magnamed.

Item	Specification
Nursing Call	Redel connector - 3 pin female receptacle Color-Red Only use cables that are checked by Magnamed.
Distal flow sensor (Envitec or reusable)	Redel Connector – female 6 pin receptacle

(1) Optional



ATTENTION

- **Connected devices shall be approved medical devices that complies with IEC 60601-1.**
- **Use only certified cables on the equipment connectors.**
- **Connecting the ventilator to an IT network may result in risks to the patient, operator, or third party that has not been identified previously. The responsible organization shall identify, analyze, evaluate and control those risks.**
- **Subsequent changes to the IT network may introduce new risks and require further analysis by the responsible organization. Changes to the IT network include: configuration changes, connection of additional items, disconnection of items, updating of equipment connected to the IT network and improvement of equipment connected to the data communication port.**
- **Failure to implement the communication protocol will result in failure to send data to other equipment.**

10.4.4.1 Protocol used for data communication with external devices

The Ethernet port may be used to share ventilator data, such as adjusted parameters, monitored parameters, waveforms, and alarm logging for electronic health recorders, in addition, connection with a distributed alarm system. The data has on average a delay of 8 seconds between the instant of data generation and the data output connector.

To send data to other equipment, the IT network must be scalable, with high availability and low data propagation delay.

The required network settings include a Dynamic Host Configuration Protocol (DHCP) enabled network server, so that the SEMP receives a valid Internet Protocol (IP). Communication is done through the TCP protocol in the IT network. For communication with the electronic health recorder, an appropriate communication protocol shall be implemented. To obtain the implementation guide for the communication protocol, contact MagnaService.

The information transitions from the following form: Fleximag Max sends the data to the responding client it received. The customer can ask questions or an operational request for Fleximag Max that immediately responds or confirms the request.



ATTENTION

- *To obtain the implementation guide for the communication protocol, contact MagnaService.*
- *This implementation shall be performed in a network with the characteristics described in 10.4.4.1 by an IT specialist.*
- *IT network failures to provide the required features may lead to delays in data communication or incorrect, incomplete or corrupted data transmission, resulting in incorrect information for the user.*

10.4.5 Gas Inlet Connector

Table 15 - Gas Inlet Connector

Item	Specification
Connections	According to CGA V-5
Hoses and extensions	According to ISO 5359: 2008
Compressed air and oxygen inlet pressure	200 to 600 kPa (29 to 87 psi)
Respiratory circuit	According to ISO 5367: 2014



ATTENTION

- *Input pressures exceeding the specified limit can damage the equipment.*
- *For inlet pressures less than 250 kPa, the maximum flow shall be 120 L / min.*



Observations

- *All materials that make up the product are compatible with oxygen gas, ambient air and medical compressed air.*

10.5 Pneumatic Specifications

10.5.1 Pneumatic layout¹

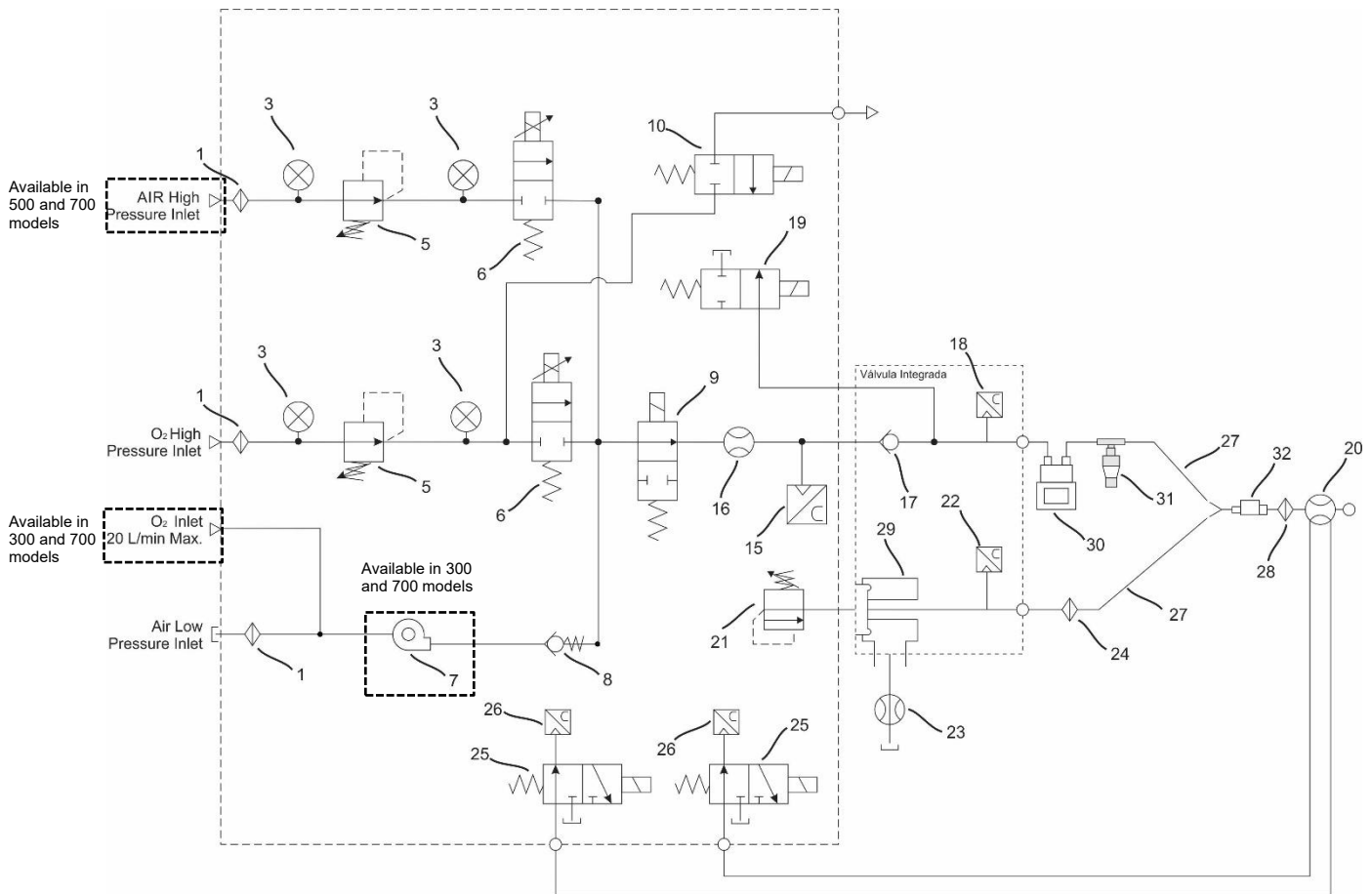

Legend

- | | | | |
|----|--|----|--|
| 1 | Filter | 20 | Proximal Flow Sensor |
| 3 | 150 psi Pressure Sensor | 21 | Linear actuator |
| 5 | 45 psi pressure regulated | 22 | Exp pressure measurement point |
| 6 | 200 LPM Proportional | 23 | Distal flow sensor |
| 7 | Flow Air System | 24 | HEPA filter |
| 8 | One-way valve (anti-asphyxiation) | 25 | x-1 / 6 psi Solenoid valve |
| 9 | Solenoid Valve On/Off (NIF) | 26 | Measurement point (proximal pressure differential) |
| 10 | x-5 100 psi Solenoid Valve (Nebulizer) | 27 | Respiratory circuit |
| 15 | O ₂ concentration cell | 28 | HME filter |
| 16 | Internal Flow Sensor | 29 | Integrated valve with diaphragm |
| 17 | One-way valve – low pressure (insp output) | 30 | Humidifier (optional) |
| 18 | Insp pressure measurement point | 31 | Nebulizer (optional) |
| 19 | On/Off Overpressure Valve | 32 | Capnograph (optional) |

Figure 1 – Pneumatic layout

¹ Pneumatic layout for Fleximag Max 700 model
 High pressure air intake for Fleximag Max 500 and Fleximag Max 700 models only
 FlowAir system only for Fleximag 300 and Fleximag 700 models

Observations

- *Circuit diagram, component list, calibration and repair instructions that help maintenance personnel are presented in the technical service manual.*

10.6 Internal Flow Transducer Specifications

Table 16 - Internal Flow Transducer - General Specifications

General specifications	
<p>The internal flow transducer contains two sensors, one flow sensor and the other to measure the temperature.</p> <p>Each sensor has an independent nonlinear voltage output. To determine the mass flow of gas passing through the transducer, the output voltage of each of the sensors is measured.</p> <p>A microprocessor processes the results and calculates the flow using a specific algorithm.</p> <p>The circuit that measures the flow is usually known as a thermal sensor or hot wire anemometer.</p> <p>This flow transducer uses a heated wire sensor and maintained at a temperature of 150 ° C.</p> <p>The velocity of the gas passing through the sensor determines the rate of heat transfer between the sensor and the gas.</p> <p>This heat transfer rate is translated into a voltage necessary to maintain the temperature at 150 ° C.</p> <p>Consequently, this voltage is a function of the mass flow of gas passing through the sensor.</p> <p>The heat transfer rate is also influenced by the gas temperature.</p> <p>A thermistor circuit is used to measure the temperature of the gas and a correction is also made through specific algorithm.</p>	
Reading range	Air: 0 to 300 SLPM O ₂ : 0 to 300 SLPM
Specified Tolerance	Air: 2.0% or 0.05 SLPM (whichever is greater) O ₂ : 2.0% or 0.05 SLPM (whichever is greater)
Resistance	< 2.5mbar
Gas temperature range	5 to 46°C
Humidity Range	Dry gas (< 10% UR)
Operating Pressure	Atmospheric pressure
Power supply	5V ± 10% sensor and 2.7V - 5.5V Eeprom
Response Time	< 2.5ms

Burst pressure	Above 100 psi
Weight	21g

10.7 Distal Flow Sensor Specifications (Envitec or reusable)

Table 17 - Distal Flow Sensor (Envitec or reusable) - General Specifications

General specifications	
Intended use	Measure the flow expired by the patient.
Working principle	Thermal sensor or hot wire anemometer, thermistor.
Reading range	0 to 160 SLPM
Tolerance	$\pm 8\%$
Resistance	< 2.5mbar
Pressure range	$\pm 100\text{mbar}$
Lifetime	While calibration is successful
Material	MABS

10.8 Proximal Flow Sensor Specifications

Table 18 - Proximal Flow Sensor - General Specifications ADULT

General specifications	
Intended use	Measure the inspired and expired flow of the patient.
Working principle	Pressure differential
Reading range	-180 to 180 SLPM
Tolerance	$\pm 10\%$
Material	PSU

10.9 Pressure Sensor Specifications

Table 19 - Pressure sensor - General specifications

General specifications	
Intended use	Measure the inspired pressure of the patient
Working principle	Pressure differential
Reading range	-60 to 120 cmH ₂ O
Tolerance	± 5% (0 to 85°C)
Sensitivity	90mV/kPa
Response Time	< 1ms

10.10 Galvanic O₂ cell specifications

Table 20 – Galvanic O₂ cell specifications

General specifications	
Intended use	Measure the O ₂ concentration delivered from the equipment to the patient.
Measuring Range	0 to 100%
Exit signal	9 – 13 mV
Response time 90%	13 s
Accuracy	± 2%
Linearity	± 2%
Recommended flow rate	0.1 – 10 lpm
Data sampling rate	7 Hz
Method for calculating the gas level reading	Simple moving average (SMA) of 64 positions acquired every 140ms
Respiratory rate	The Respiratory Rate is displayed every 3 breaths and the mean value is updated with each breath.
Effects of gas and vapor interference	
Gas or steam	Gas level
Response to 80% NO	< 5%
Response to 7,5% Halothane	< 5%
Response to 7,5% Isoflurane	< 5%
Response to 7,5% Enflurane	< 5%
Response to 9% Sevoflurane	< 5%
Response to 20% Desflurane	< 5%

General specifications	
Response to 10% CO ₂	< 5%

10.11 Paramagnetic O₂ cell Specification

Table 21 – Paramagnetic O₂ cell specification

General specifications	
Intended use	Measure the O ₂ concentration delivered from the equipment to the patient.
Measuring Range	-15% to +200%
Exit signal	0 - 50 mV
Response time 90%	< 8 s
Accuracy	< ± 0.2%
Linearity	< ± 0.2%
Data sampling rate	7 Hz
Method for calculating the gas level reading	Simple moving average (SMA) of 64 positions acquired every 140ms
Respiratory rate	The Respiratory Rate is displayed every 3 breaths and the mean value is updated with each breath.
Effects of gas and vapor interference	
Gas or steam	Gas level
N ₂ O	- 0,20%
CO ₂	- 0,26%
H ₂ O	- 0,03%
Methane	- 0,16%
CO	0,06
Helium	0,29
NO	42,56
NO ₂	5,00

10.12 Ventilation Modes Specifications

10.12.1 VCV

VCV - Mandatory volume-controlled ventilation	
<p>Description:</p> <p>In this mode, the respiratory rate, tidal volume, and inspiratory flow (or inspiratory ratio or time) are set.</p> <p>The onset of inspiration (triggering) occurs according to the pre-established respiratory rate. triggering occurs exclusively for time, if the sensitivity setting is off.</p> <p>The transition between inspiration and expiration (cycling) occurs after release of the pre-set tidal volume at given velocity through the flow (or ratio or inspiratory time).</p>	<p>Adjusted Parameters:</p> <ul style="list-style-type: none">• VOLUME• RATE• FLOW or RATIO I:E or INS TIME• PEEP• O₂ CONCENTRATION• LIMIT PRESSURE• PAUSE (% or s)• PRESSURE TRIGGER• FLOW TRIGGER• FLOW WAVE <p>Note: Automatic backup ⁽¹⁾ 1 - Whenever the set apnea time is reached, the ventilator triggers a ventilator cycle, the setting of which is based on the current mode settings.</p>

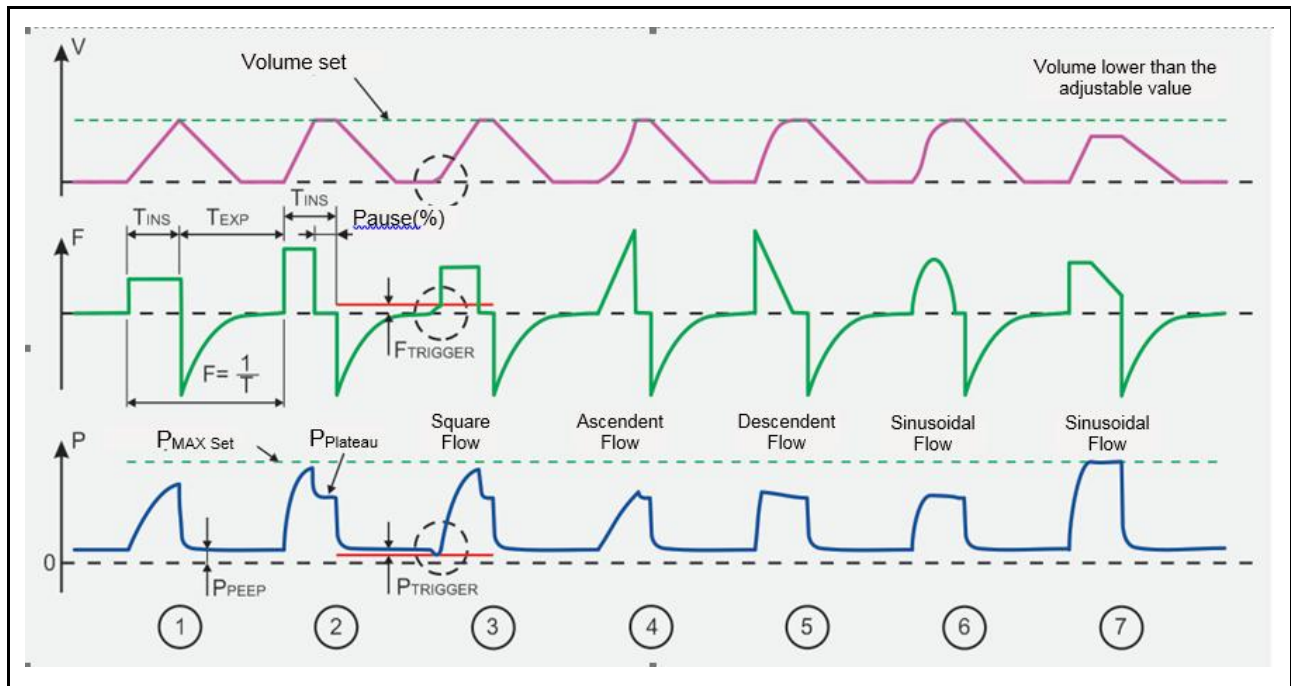

Once all ventilation parameters are received by the ventilator, it calculates the T_{INS} , T_{EXP} , T_{PAUSE} and I: E Ratio, as a function of the adjusted Flow, Pause, Wave and Frequency, thus obtaining all ventilation control times.

1. Ventilation without Inspiratory Pause, after the T_{INS} the ventilator cycles to expiration. The inspiratory pressure reached is a consequence of the volume delivered and the resistance and compliance of the patient's respiratory circuit.
2. Ventilation with Inspiratory Pause, after delivery of the set volume the ventilator keeps the expiration interrupted until T_{INS} is completed, after which the ventilator cycles to expiration, the characteristic is the formation of pressure plateau (the difference between the peak and the plateau depends of airway resistance).
3. If pressure or flow triggers are activated, then the ventilator attempts to synchronize the onset of the next inspiration with the patient's effort, according to the established levels. The information on which trigger type triggered the inspiratory cycle is reported in the status and message area. The patient's inspiratory effort detection for synchronization occurs at any point in the expiratory time.

👁 Observations

- *If the patient makes inspiratory efforts and the triggers are properly adjusted, the ventilatory mode becomes assisted-controlled. In this situation, the monitored respiratory rate may be significantly greater than that adjusted.*

4. ASCENDENT (or accelerated) flow waveform.
5. DECENDENT (or decelerated) flow waveform.
6. SINUSOIDAL flow waveform.
7. Representation of Pressure Limitation. In this situation the ventilator limits the pressure to the adjusted value because of factors such as patient compliance and imposed pressure limit, the adjusted volume is NOT DELIVERED, and this condition is informed in the alarms area (LIMITED PRESSURE message) on the screen.



WARNING

- ***Upon reaching the pressure limit set at the maximum pressure setting (LIMITED PRESSURE alarm), the set volume is NOT DELIVERED.***
- ***The default values are initial reference only.***
- ***Readjust ventilation parameters as required by the patient.***

10.12.2 PCV

PCV - Mandatory pressure-controlled ventilation	
<p>Description:</p> <p>In this ventilatory mode, the respiratory rate, the inspiratory time, and the inspiratory pressure limit are set. The onset of inspiration (triggering) occurs according to the pre-established respiratory rate. The trigger, if the sensitivity adjustment is deactivated, is determined exclusively by the respiratory rate, and cycling (end of inspiration and beginning of expiration) is determined by the inspiratory time.</p> <p>The tidal volume depends on the preset inspiratory pressure, the respiratory system impedance conditions and the inspiratory time selected by the operator.</p>	<p>Adjusted Parameters:</p> <ul style="list-style-type: none"> • CONTROL PRESSURE • RATE • INSPIRATORY TIME • PEEP • O₂ CONCENTRATION • RISE TIME • PRESSURE TRIGGER • FLOW TRIGGER <p>Note: Automatic backup ⁽¹⁾ 1 - Whenever the set apnea time is reached, the ventilator triggers a ventilator cycle, the setting of which is based on the current mode settings.</p>

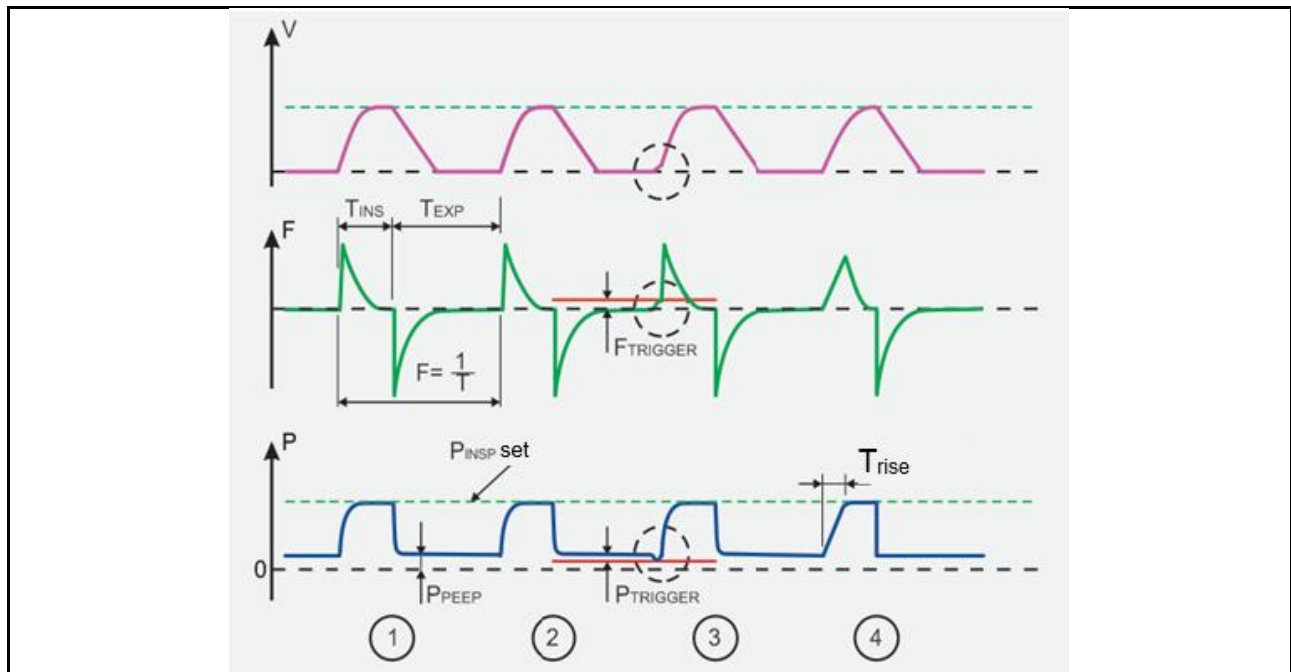

Once all ventilation parameters are set on the ventilator, it calculates the period, T_{EXP} and I: E ratio in function of T_{INS} and Rate, thus obtaining all ventilation control times.

1. Pressure Controlled Ventilation - The ventilator seeks to achieve adjusted inspiratory pressure in the shortest possible time, and this is accomplished by controlling the inspiratory flow.
2. Volume delivered to the patient is a consequence of the resistance and complacency of the patient's breathing circuit. The ventilator remains at the inspiratory pressure level set during T_{INS} after which the ventilator cycles to expiration, keeping the PEEP pressure set.
3. If pressure or flow triggering is activated, then the ventilator attempts to synchronize the onset of the next inspiration with the patient's effort, according to the established levels. The information on which trigger type triggered the inspiratory cycle is reported in the status and message area of the screen. The patient's inspiratory effort detection for synchronization occurs at any point in the expiratory time.

Observation

- *If the patient makes inspiratory efforts and the sensitivities are properly adjusted, the ventilatory mode becomes assisted-controlled. In this situation, the monitored respiratory rate may be significantly greater than that adjusted.*

4. The rise time of the pressure can be adjusted by T_{RISE} (RISE TIME), the initial peak flow is generally lower than that in which $T_{RISE} = 0$ (depends on the resistance and compliance of the patient's respiratory circuit).



WARNING

- *The default values are initial reference only.*
- *Readjust ventilation parameters as required by the patient.*

10.12.3 PLV

PLV - Pressure limited ventilation	
<p>Description:</p> <p>In this bias-flow ventilatory mode, the respiratory rate, inspiratory time, and inspiratory pressure limit are set. The onset of inspiration (triggering) occurs according to the pre-established respiratory rate. The trigger, if the sensitivity adjustment is disabled, is determined exclusively by the respiratory rate, but cycling (end of inspiration and beginning of expiration) occurs according to the inspiratory time.</p> <p>The tidal volume depends on the preset inspiratory pressure, the respiratory system impedance conditions and the inspiratory time selected by the operator.</p> <p>Usually by observing the flow curve, you see a peak of flow that decreases as time goes by.</p>	<p>Adjusted Parameters:</p> <ul style="list-style-type: none">• CONTROL PRESSURE² / INSPIRATORY PRESSURE (Neonatal)• RATE• INSPIRATORY TIME• PEEP• O₂ CONCENTRATION• FLOW (\dot{V})• PRESSURE TRIGGER• FLOW TRIGGER <p>Note: Automatic backup ⁽¹⁾</p> <p>1 - Whenever the set apnea time is reached, the ventilator triggers a ventilator cycle, the setting of which is based on the current mode settings.</p> <p>2- The control pressure setting (Pr Control) in pediatric or adult patients, refers to a relative pressure, that is, it adjusts the pressure value ABOVE PEEP.</p>

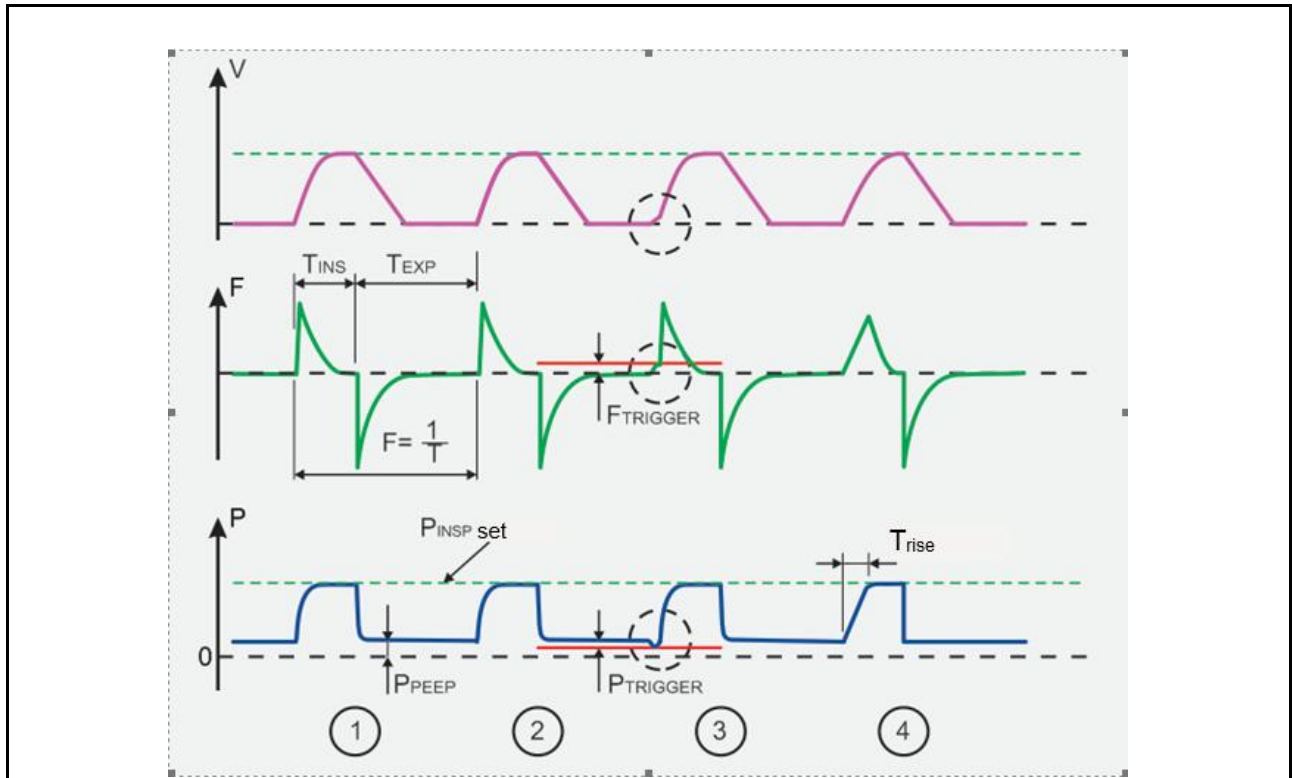

Once all ventilation parameters are set in the ventilator, it calculates T_{EXP} as a function of Rate and T_{INS} , thus obtaining all ventilation control times.

1. Pressure Limited Ventilation - The ventilator seeks to achieve adjusted inspiratory pressure, and this is accomplished by occluding the integrated valve. It is important to note that the rise time of the pressure is dependent on the adjusted bias flow.
2. Volume delivered to the patient is a consequence of the resistance and complacency of the patient's breathing circuit. The ventilator remains at the inspiratory pressure level set during T_{INS} after which the ventilator cycles to expiration, keeping the PEEP pressure set.
3. If pressure or flow triggering is activated, then the ventilator attempts to synchronize the onset of the next inspiration with the patient's effort, according to the established levels. The information on which trigger type triggered the inspiratory cycle is reported in the status and message area of the screen. The patient's inspiratory effort detection, for synchronization, occurs at any time during the expiratory time.



WARNING

- ***The default values are initial reference only.***
- ***Readjust ventilation parameters as required by the patient.***
- ***The operator shall consider the inspiratory time and respiratory mechanics of the patient to define the bias flow adjusted. If the flow is not enough, the airway pressure may not reach the adjusted value.***

Observation

- *If the patient makes inspiratory efforts and the trigger are properly adjusted, the ventilatory mode becomes assisted-controlled. In this situation, the monitored respiratory rate may be significantly greater than that adjusted.*
-

10.12.4 PRVC

PRVC - Pressure regulated volume controlled

Description:

Time-limited, pressure-limited cycling mode that uses tidal volume as feedback to continuously adjust the pressure limit.

The first three respiratory cycles are in volume-controlled mode, allowing the ventilator to calculate respiratory mechanics. In the next cycles the ventilation is distributed with pressure limit and cycled by time to reach 60% of the adjusted volume. The onset of inspiration (triggering) occurs according to the pre-established respiratory rate. The end of the inspiration and beginning of the expiration (cycling) happens according to the adjusted inspiratory time.

At each cycle the ventilator adjusts the pressure limit (5 cmH₂O up) according to the tidal volume distributed in the previous cycle, until the tidal volume indicated by the operator is reached.

The maximum pressure limit is 5 cmH₂O below the pressure limit indicated by the operator.

Adjusted Parameters:

- VOLUME
- LIMIT PRESSURE
- RATE
- INSPIRATORY TIME
- PEEP
- O₂ CONCENTRATION
- RISE TIME
- PRESSURE TRIGGER
- FLOW TRIGGER

Note: Automatic backup ⁽¹⁾

1 - Whenever the set apnea time is reached, the ventilator triggers a ventilator cycle, the setting of which is based on the current mode settings.

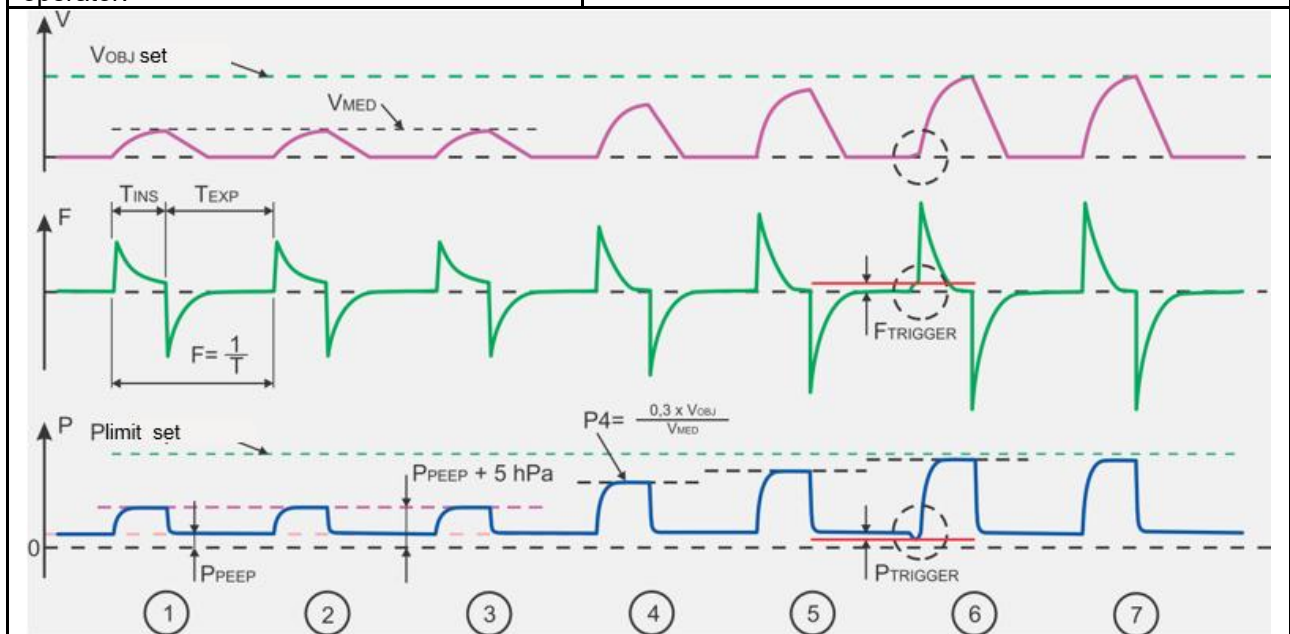

Once all ventilation parameters are set in the ventilator, it calculates the T_{EXP} as a function of Rate and T_{INS} , thus obtaining all ventilation control times.

1,2,3. Evaluation phase of lung compliance. After obtaining the compliance value the ventilator automatically sets a pressure value to reach 60% of the set volume, and then the ventilator adjusts the pressure automatically every three cycles of PCV.

4,5. Start of automatic pressure control to reach defined volume.

6. If the pressure trigger and flow trigger are active, then the ventilator seeks to synchronize the onset of the next inspiration to the patient's effort, according to the configured trigger. Detection of the patient's "window" of effort for synchronization begins in the last quarter of the period of controlled ventilation.

7. Volume reached.



WARNING

- *Upon reaching the pressure limit set at the maximum pressure setting (LIMITED PRESSURE alarm), the set volume is NOT DELIVERED.*
- *The default values are initial reference only.*
- *Readjust ventilation parameters as required by the patient.*



Observations

- *If the patient makes inspiratory efforts and the triggers are properly adjusted, the ventilatory mode becomes assisted-controlled. In this situation, the monitored respiratory rate may be significantly greater than that adjusted.*
- *Automatic pressure control occurs with $PEEP + 5\text{cmH}_2\text{O} \leq P_{Limit}$*

10.12.5 V-SIMV

V-SIMV - Volume controlled synchronized intermittent mandatory ventilation	
<p>Description:</p> <p>In V-SIMV, the respiratory rate, tidal volume and inspiratory flow or inspiratory time or ratio are set, as well as the trigger criterion for the occurrence of ventilator triggering by the patient.</p> <p>This mode allows the ventilator to apply predetermined preset cycles in sync with the patient's inspiratory effort.</p> <p>Mandatory cycles occur in the pre-determined window of time (the onset of inspiration occurs according to the pre-established respiratory rate), but synchronized with the patient's trigger.</p> <p>If there is apnea, the next cycle will be triggered by time until the patient's inspiratory incursions return.</p> <p>The transition between inspiration and expiration in the mandatory cycles occurs after release of the pre-set tidal volume at given velocity through the flow (or ratio or inspiratory time). In spontaneous cycles, cycling (transition between inhalation and expiration) occurs by flow as it falls to a certain percentage of its maximum reached value.</p> <p>In order to obtain the IMV in this mode, simply deactivate the support pressure by setting the support pressure equal to zero ($\Delta PS = 0$) or the flow and pressure sensitivities, equal to zero.</p>	<p>Adjusted Parameters:</p> <ul style="list-style-type: none">• VOLUME• RATE• FLOW or RATIO I:E or INS TIME• PEEP• O₂ CONCENTRATION• FLOW WAVE FORM• PAUSE (%)• PRESSURE TRIGGER• FLOW TRIGGER• ΔPS (Support Pressure)• RISE TIME• FLOW CYCLING (% FLOW)• LIMIT PRESSURE <p>Note: Automatic backup ⁽¹⁾ 1 - Whenever the set apnea time is reached, the ventilator triggers a ventilator cycle, the setting of which is based on the current mode settings.</p>

V-SIMV - Volume controlled synchronized intermittent mandatory ventilation

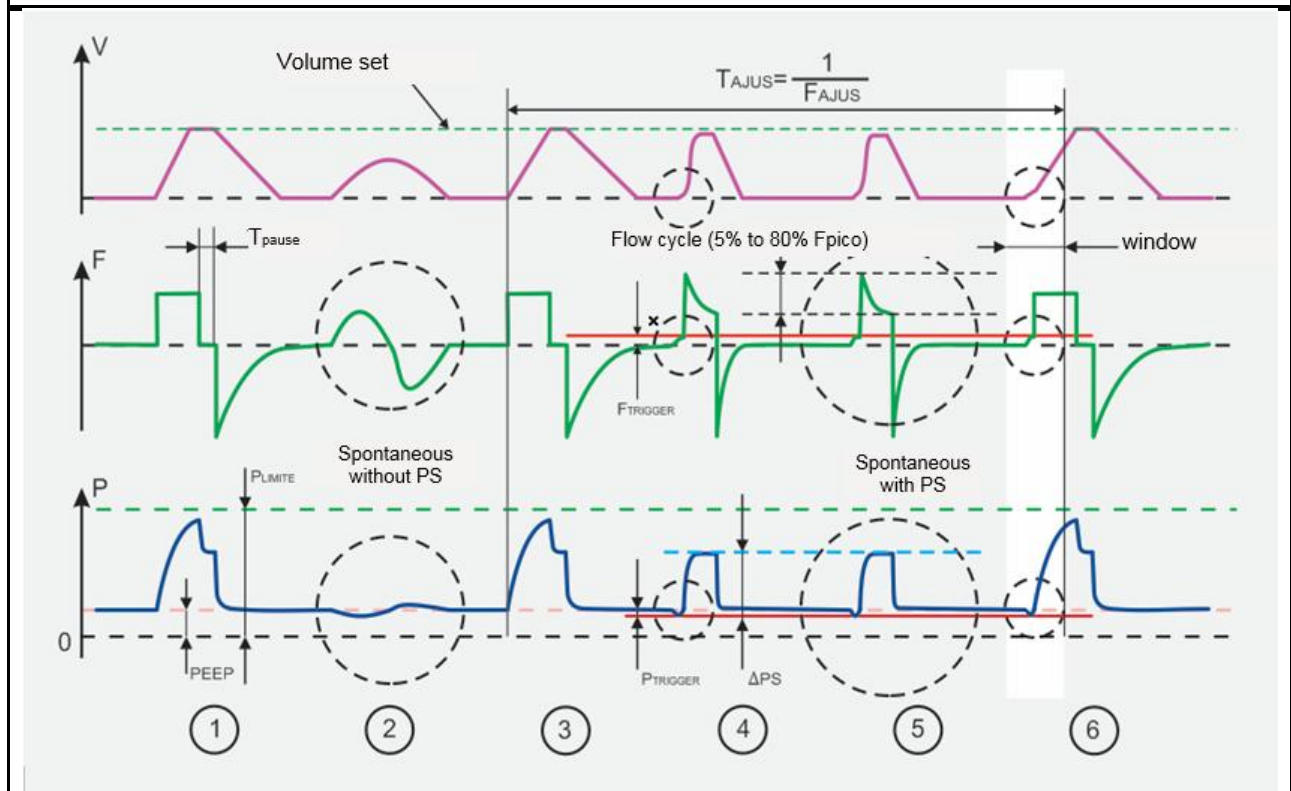

Once all ventilation parameters are set in the ventilator, it calculates the T_{INSP} and T_{EXP} in function of Flow, Pause, Wave and Rate, thus obtaining all ventilation control times.

1. It represents a cycle of VCV (volume controlled) with inspiratory pause;
2. Represents a spontaneous breathing cycle WITHOUT SUPPORT PRESSURE;
3. It represents a VCV (volume controlled) cycle after the SIMV period;
4. Represents a spontaneous breathing cycle WITH SUPPORT PRESSURE, whose cycling occurs by flow, as soon as it falls to a certain percentage of its maximum reached value.
5. The percentage of peak flow at which inspiratory phase cycles to the expiratory phase is programmable. Rise time (T_{RISE}) is also applied to support pressure (see PCV).
6. If the patient performs inspiratory effort, at the end of the SIMV (T_{SIMV}) period there is a window for synchronization of the controlled ventilation cycle, which is 'open' from $0.75 \times T_{SIMV}$, that is, in the last quarter of the period SIMV opens a synchronization window of the mandatory ventilation cycle. The information on which trigger type triggered the inspiratory cycle is reported in the message and status area of the screen.



WARNING

- **Adjusted support pressure (ΔPS) is a value above PEEP. Therefore, the inspiratory pressure of support will be the sum of PEEP and ΔPS .**
- **The default values are initial reference only.**

-
- *Readjust ventilation parameters as required by the patient.*
-

Observation

- *The monitored respiratory rate may be higher than the adjusted respiratory rate, as the patient may breathe spontaneously during the mandatory ventilation cycles.*
-

10.12.6 P-SIMV

P-SIMV – Pressure controlled synchronized intermittent mandatory ventilation	
<p>Description:</p> <p>In P-SIMV, the respiratory rate, inspiratory pressure and inspiratory time are set, as well as the sensitivity criterion for the occurrence of ventilator triggering by the patient.</p> <p>This mode allows the ventilator to apply predetermined preset cycles in sync with the patient's inspiratory effort.</p> <p>Mandatory cycles occur in the pre-determined window of time (the onset of inspiration occurs according to the pre-established respiratory rate) but synchronized with the patient's trigger.</p> <p>If there is an apnea, the next cycle will be triggered by time until the patient's inspiratory incursions return.</p> <p>The transition between inspiration and expiration in the mandatory cycles occurs after release of the pre-set tidal volume at given velocity through the flow (or ratio or inspiratory time). In spontaneous cycles, cycling (transition between inhalation and expiration) occurs by flow as it falls to a certain percentage of its maximum reached value.</p> <p>In order to obtain the IMV in this mode, simply deactivate the support pressure by setting the support pressure equal to zero ($\Delta PS = 0$) or the flow and pressure sensitivities, equal to zero.</p>	<p>Adjusted Parameters:</p> <ul style="list-style-type: none"> • CONTROL PRESSURE² / INSPIRATORY PRESSURE (Neonatal) • RATE • INSPIRATORY TIME • PEEP • O₂ CONCENTRATION • RISE TIME • ΔPS (Support Pressure) • FLOW CYCLING (% FLOW) • PRESSURE TRIGGER • FLOW TRIGGER • Flow (\dot{V} - NEONATAL) <p>Note: Automatic Backup ⁽¹⁾</p> <p>1 - Whenever the set apnea time is reached, the ventilator triggers a ventilator cycle, the setting of which is based on the current mode settings.</p> <p>2- The control pressure setting (Pr Control) in pediatric or adult patients, refers to a relative pressure, that is, it adjusts the pressure value ABOVE PEEP.</p>

P-SIMV – Pressure controlled synchronized intermittent mandatory ventilation

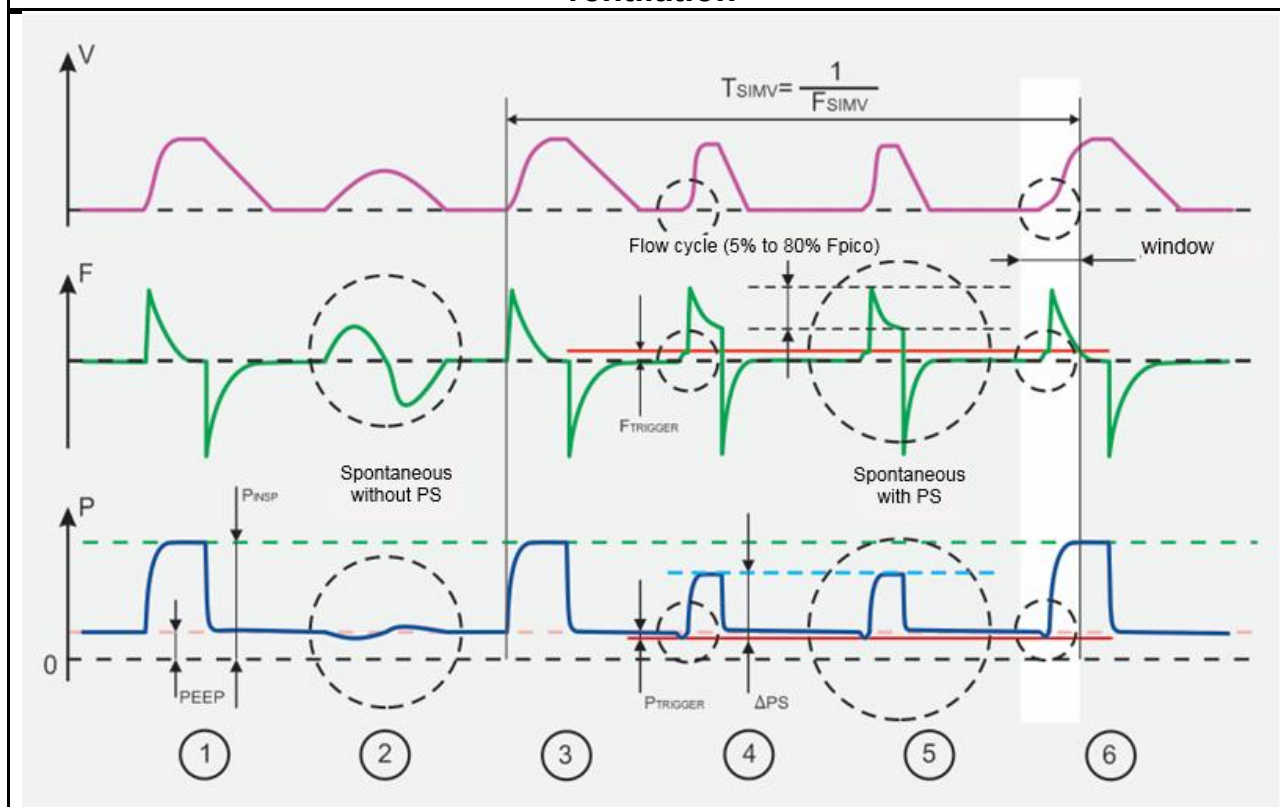

Once all the ventilation parameters are set in the ventilator, it calculates the T_{EXP} according to T_{INS} and Rate, thus obtaining all ventilation control times.

1. Represents a PCV (pressure controlled) cycle during T_{INS}
2. Represents a spontaneous breathing cycle WITHOUT SUPPORT PRESSURE;
3. Represents a PCV (pressure controlled) cycle after the SIMV period;
4. Represents a spontaneous breathing cycle WITH SUPPORT PRESSURE, whose cycling occurs by flow, as soon as it falls to a certain percentage of its maximum reached value.
5. The percentage of peak flow at which inspiratory phase cycles to the expiratory phase is programmable. Rise time (T_{RISE}) is also applied to support pressure (see PCV).
6. If the patient performs inspiratory effort, at the end of the SIMV (T_{SIMV}) period there is a window for synchronization of the controlled ventilation cycle, which is 'open' from 0.75 x T_{SIMV}, that is, in the last quarter of the period SIMV opens a synchronization window of the mandatory ventilation cycle. The information on which trigger type triggered the inspiratory cycle is reported in the message area and status of the screen.



WARNING

- **Adjusted support pressure (ΔPS) is a value above PEEP. Therefore, the inspiratory pressure of support will be the sum of PEEP and ΔPS.**

-
- *The default values are initial reference only.*
 - *Readjust ventilation parameters as required by the patient.*
-

Observation

- *The monitored respiratory rate may be higher than the adjusted respiratory rate, as the patient may breathe spontaneously during the mandatory ventilation cycles.*
-

10.12.7 CPAP/PS

CPAP / PS - Spontaneous ventilation with positive airway pressure and pressure support	
<p>Description:</p> <p>In CPAP / PS, the ventilator allows the patient to breathe spontaneously, but provides continuous pressurization in both inspiration and expiration, and assist ventilation during inspiration by maintaining a supporting pressure until the patient's inspiratory flow is reduced to a critical (adjustable) level of inspiratory peak flow reached.</p> <p>The onset of inspiration occurs when the patient makes an effort that is recognized by the ventilator according to the adjusted trigger. If the backup is active and the patient goes into apnea, the onset of inspiration will occur according to the set apnea time.</p> <p>This allows the patient to control the respiratory rate and inspiratory time, and thus the volume of inspiratory air.</p> <p>Cycle (transition between inspiration and expiration) occurs by flow as it falls to a certain percentage of its maximum reached value.</p> <p>If the support pressure value (ΔPS) is set to 0 (ZERO) and the means for cycle triggering are both turned off, ventilation with pure CPAP mode will be activated, which is a mode of spontaneous ventilation not assisted by the ventilator.</p> <p>The tidal volume depends on the respiratory effort of the patient and the conditions of respiratory mechanics of the lung and chest wall.</p>	<p>Adjusted Parameters:</p> <ul style="list-style-type: none"> • PEEP / CPAP • O₂ CONCENTRATION • ΔPS (Support Pressure) • CYCLE (% FLOW) • RISE TIME • PRESSURE TRIGGER • FLOW TRIGGER • FLOW (NEONATAL) • BACKUP <ul style="list-style-type: none"> ○ VCV Backup <ul style="list-style-type: none"> ▪ VOLUME ▪ RATE ▪ FLOW ▪ LIMIT PRESSURE ▪ FLOW WAVE ▪ PAUSE ○ PCV Backup <ul style="list-style-type: none"> ▪ CONTROL PRESSURE²/ INSPIRATORY PRESSURE (Neonatal) ▪ RATE ▪ INSP TIME ○ PLV-NEONATAL Backup <ul style="list-style-type: none"> ▪ INSP PRESSURE ▪ RATE ▪ INSP TIME ○ Automatic Backup⁽¹⁾ <p>1 - Whenever the set apnea time is reached, the ventilator triggers a ventilator cycle, the setting of which is based on the current mode settings.</p> <p>2- The controlled pressure setting (Pr Control) in pediatric or adult patients, refers to a relative pressure, that is, it adjusts the pressure value ABOVE PEEP.</p>

CPAP / PS - Spontaneous ventilation with positive airway pressure and pressure support

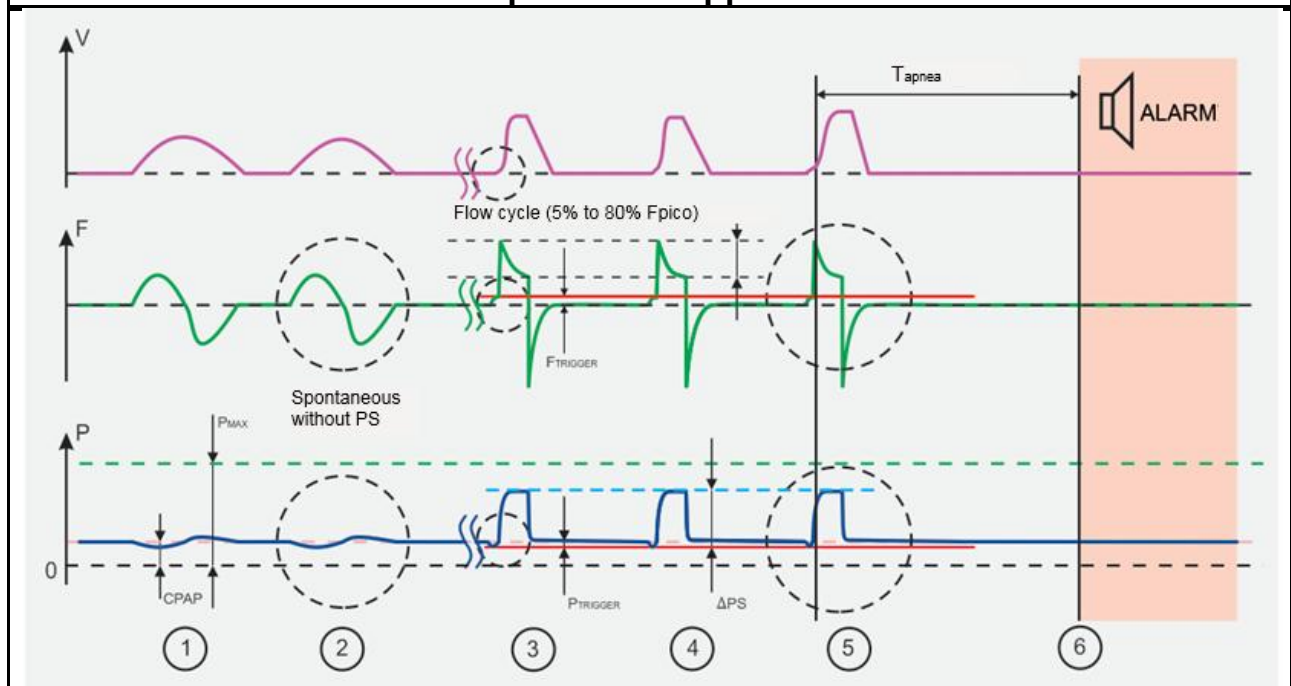

1 and 2. represent spontaneous cycles with the support pressure in ZERO.

3, 4 and 5. They represent spontaneous breathing cycles of the patient with support pressure greater than zero. T_{RISE} (Rise Time) of the support pressure can be adjusted so that the initial flow is smoothed.

The cycling occurs by flow as soon as it falls to a certain percentage of its maximum reached value.

6. If the patient goes into apnea, after T_{APNEIA} (s) the ventilator will present this condition through an alarm in its message area on the screen and will start the selected backup ventilation, according to the settings and programmed parameters.



WARNING

- **Adjusted support pressure (ΔPS) is a value above PEEP. Therefore, the inspiratory pressure of support will be the sum of PEEP and ΔPS .**
- **The default values are initial reference only.**
- **Readjust the ventilation parameters according to the patient's need**

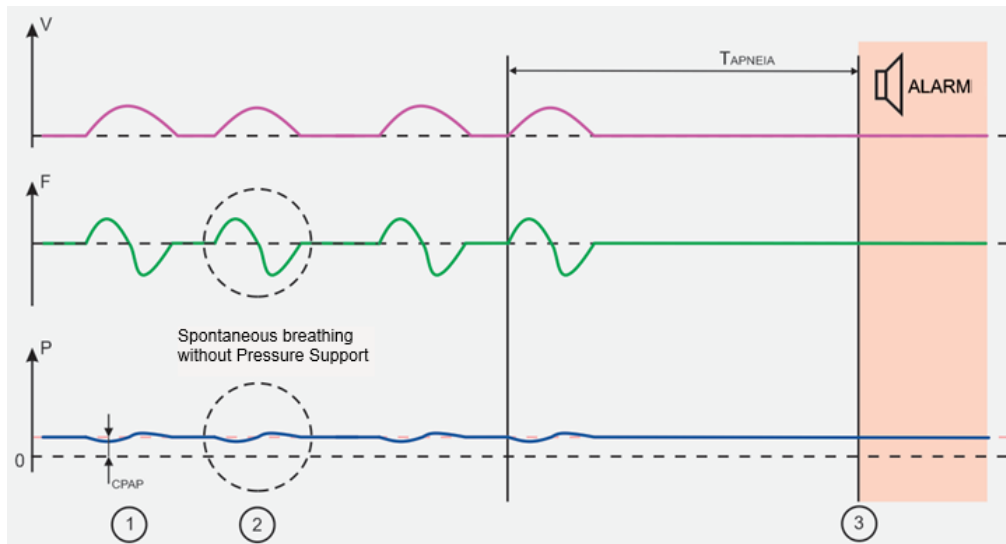

1 and 2. They represent spontaneous cycles.

1. If the patient does not breathe after the time for apnea, the ventilator enters the backup and activates the apnea alarm.

10.12.8 DualPAP

DualPAP - Two-stage positive pressure ventilation			
<p>Description:</p> <p>In DualPAP, the ventilator operates at two pressure levels set by the operator, Superior Pr and Inferior Pr:</p> <p>The change to the lower pressure level (end of inspiration) occurs at the end of Superior T (time set for the superior pressure level). Likewise, restoring the superior pressure level (beginning of inspiration) occurs as soon as the Lower T (the time for the lower pressure level) is exhausted.</p> <p>Consequently, the respiratory rate and the I: E ratio are directly related to this alternation between levels.</p> <p>DualPAP allows spontaneous cycles at both pressure levels and counts with the possibility of synchronization with the patient's inspiratory effort. Cycle (transition between inspiration and expiration) occurs by flow as it falls to a certain percentage of its maximum reached value.</p> <p>Without spontaneous breathing, DualPAP is similar to the controlled pressure mode, differing from this by adjusting the times (Superior T and Inferior T) rather than respiratory rate.</p> <p>The onset of inspiration occurs when the patient makes an effort that is recognized by the ventilator according to the adjusted trigger. If the backup is active and the patient goes into apnea, the onset of inspiration will occur according to the set apnea time.</p>	<p>Adjusted Parameters:</p> <ul style="list-style-type: none"> • SUPERIOR PR. • SUPERIOR T. • INFERIOR PR. • INFERIOR T. • O₂ CONCENTRATION • ΔPS (Support Pressure) • LIMIT PRESSURE • CYCLE (% FLOW) • PRESSURE TRIGGER • FLOW TRIGGER • RISE TIME • FLOW (\dot{V} - NEONATAL); • BACKUP <table style="width: 100%; border: none;"> <tr> <td style="vertical-align: top;"> <ul style="list-style-type: none"> ○ VCV Backup <ul style="list-style-type: none"> ▪ VOLUME ▪ RATE ▪ FLOW ▪ PEEP ▪ FLOW WAVE ▪ PAUSE ○ PCV Backup <ul style="list-style-type: none"> ▪ CONTROL PRESSURE² / INSPIRATORY PRESSURE (Neonatal) ▪ RATE ▪ INSPIRATORY TIME ▪ PEEP </td> <td style="vertical-align: top;"> <ul style="list-style-type: none"> ○ PLV-NEONATAL Backup <ul style="list-style-type: none"> ▪ INSP PRESSURE ▪ RATE ▪ INSPIRATORY TIME ▪ PEEP ○ Automatic Backup⁽¹⁾ <p>1 – Whenever the set apnea time is reached, the ventilator triggers a ventilator cycle, the setting of which is based on the current mode settings.</p> <p>2- The controlled pressure setting (Pr Control) in pediatric or adult patients, refers to a relative pressure, that is, it adjusts the pressure value ABOVE PEEP</p> </td> </tr> </table>	<ul style="list-style-type: none"> ○ VCV Backup <ul style="list-style-type: none"> ▪ VOLUME ▪ RATE ▪ FLOW ▪ PEEP ▪ FLOW WAVE ▪ PAUSE ○ PCV Backup <ul style="list-style-type: none"> ▪ CONTROL PRESSURE² / INSPIRATORY PRESSURE (Neonatal) ▪ RATE ▪ INSPIRATORY TIME ▪ PEEP 	<ul style="list-style-type: none"> ○ PLV-NEONATAL Backup <ul style="list-style-type: none"> ▪ INSP PRESSURE ▪ RATE ▪ INSPIRATORY TIME ▪ PEEP ○ Automatic Backup⁽¹⁾ <p>1 – Whenever the set apnea time is reached, the ventilator triggers a ventilator cycle, the setting of which is based on the current mode settings.</p> <p>2- The controlled pressure setting (Pr Control) in pediatric or adult patients, refers to a relative pressure, that is, it adjusts the pressure value ABOVE PEEP</p>
<ul style="list-style-type: none"> ○ VCV Backup <ul style="list-style-type: none"> ▪ VOLUME ▪ RATE ▪ FLOW ▪ PEEP ▪ FLOW WAVE ▪ PAUSE ○ PCV Backup <ul style="list-style-type: none"> ▪ CONTROL PRESSURE² / INSPIRATORY PRESSURE (Neonatal) ▪ RATE ▪ INSPIRATORY TIME ▪ PEEP 	<ul style="list-style-type: none"> ○ PLV-NEONATAL Backup <ul style="list-style-type: none"> ▪ INSP PRESSURE ▪ RATE ▪ INSPIRATORY TIME ▪ PEEP ○ Automatic Backup⁽¹⁾ <p>1 – Whenever the set apnea time is reached, the ventilator triggers a ventilator cycle, the setting of which is based on the current mode settings.</p> <p>2- The controlled pressure setting (Pr Control) in pediatric or adult patients, refers to a relative pressure, that is, it adjusts the pressure value ABOVE PEEP</p>		

DualPAP - Two-stage positive pressure ventilation

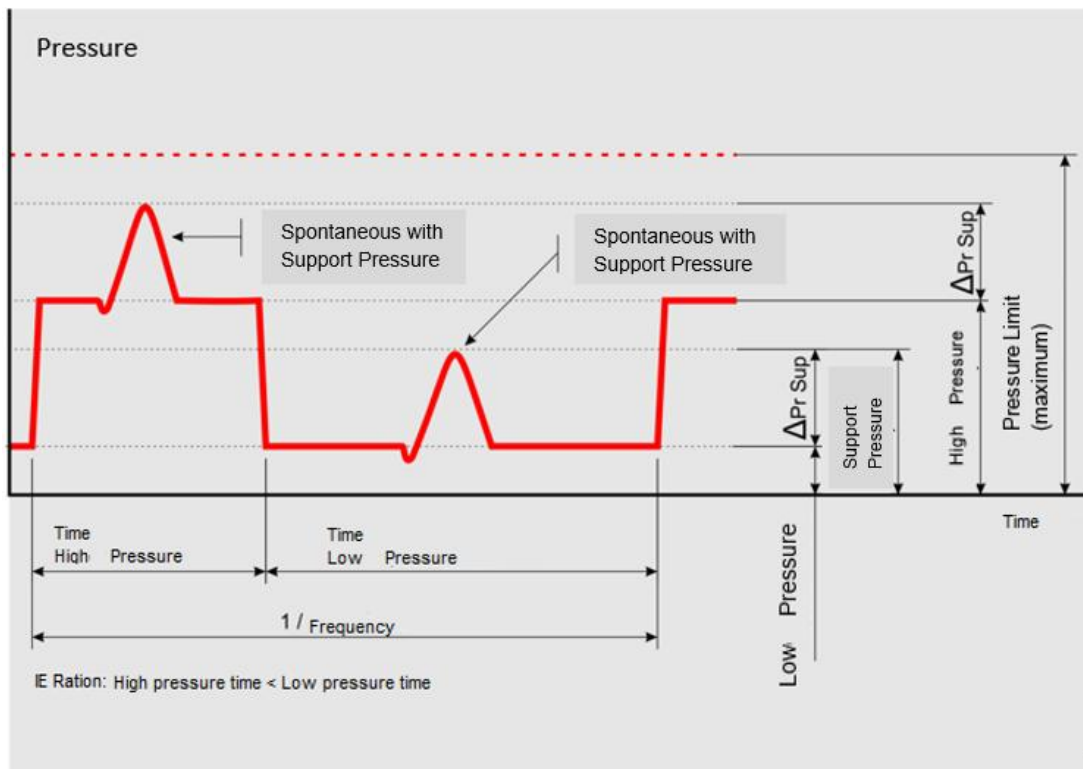
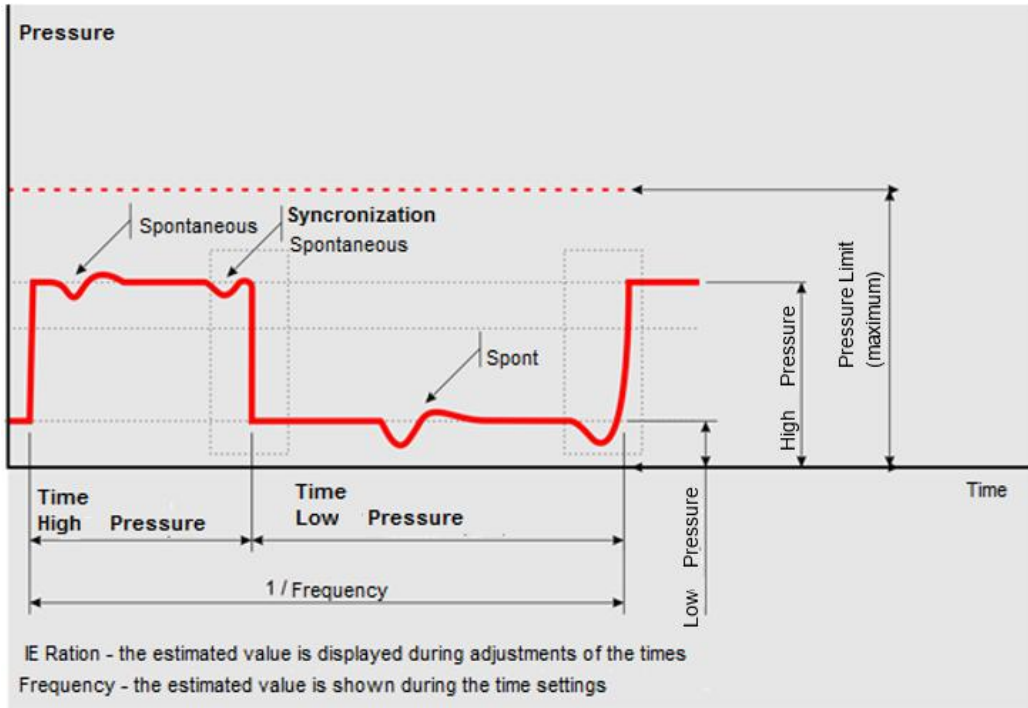



WARNING

- *The support pressure (ΔPS) is a value above the superior or inferior pressure. Therefore, the maximum support pressure will be the sum of that reference pressure and ΔPS .*
- *The default values are initial reference only.*
- *Readjust ventilation parameters as required by the patient.*
- *In the absence of spontaneous cycles when in DualPAP, adjust the superior and inferior pressures so that the minute volume delivered to the patient is enough.*



Observation

- *Changes in pressure levels are synchronized.*

10.12.9 APRV

APRV - Continuous positive pressure ventilation and airway pressure relief

<p>Description:</p> <p>In APRV, the ventilator operates at two pressure levels set by the operator, Superior Pr and Inferior Pr.</p> <p>The transient relief for the lower pressure level (end of inspiration) occurs at the end of the superior T (time set for the superior pressure level). Likewise, restoring the superior pressure level (beginning of inspiration) occurs as soon as the inferior T (pressure relief time) is exhausted.</p> <p>Consequently, the respiratory rate and the resulting I: E ratio are directly related to this alternation between levels.</p> <p>APRV has the characteristic of inversion of the I: E ratio, where the time of the inferior pressure level is usually less than that of the superior pressure level, functioning only as a temporary relief. Cycle (transition between inspiration and expiration) occurs by flow as it falls to a certain percentage of its maximum reached value.</p> <p>Without spontaneous breathing, APRV is similar to the controlled pressure mode, differing from this by adjusting the times (superior and inferior) rather than the respiratory rate.</p> <p>The onset of inspiration occurs when the patient makes an effort that is recognized by the ventilator according to the adjusted trigger. If the backup is active and the patient goes into apnea, the onset of inspiration will occur according to the set apnea time.</p>	<p>Adjusted Parameters:</p> <ul style="list-style-type: none"> • SUPERIOR PR. • SUPERIOR T. • INFERIOR PR. • INFERIOR T. • O₂ CONCENTRATION • ΔPS (Support Pressure) • LIMIT PRESSURE • CYCLE (% FLOW) • PRESSURE TRIGGER • FLOW TRIGGER • RISE TIME • FLOW (\dot{V} - NEONATAL); • BACKUP • ○ VCV Backup <ul style="list-style-type: none"> ▪ VOLUME ▪ RATE ▪ FLOW ▪ PEEP ▪ FLOW WAVE ▪ PAUSE ○ PCV Backup <ul style="list-style-type: none"> ▪ CONTROL PR²/INSPIRATORY PRESSURE (Neonatal) ▪ RATE ▪ INSPIRATORY TIME ▪ PEEP ○ PLV-NEONATAL Backup <ul style="list-style-type: none"> ▪ INSP PRESSURE ▪ RATE ▪ INSPIRATORY TIME ▪ PEEP ○ Automatic Backup⁽¹⁾ <p>1 – Whenever the set apnea time is reached, the ventilator triggers a ventilator cycle, the setting of which is based on the current mode settings.</p> <p>2- The controlled pressure setting (Pr Control) in pediatric or adult patients, refers to a relative pressure, that is, it adjusts the pressure value ABOVE PEEP</p>
--	---

APRV - Continuous positive pressure ventilation and airway pressure relief

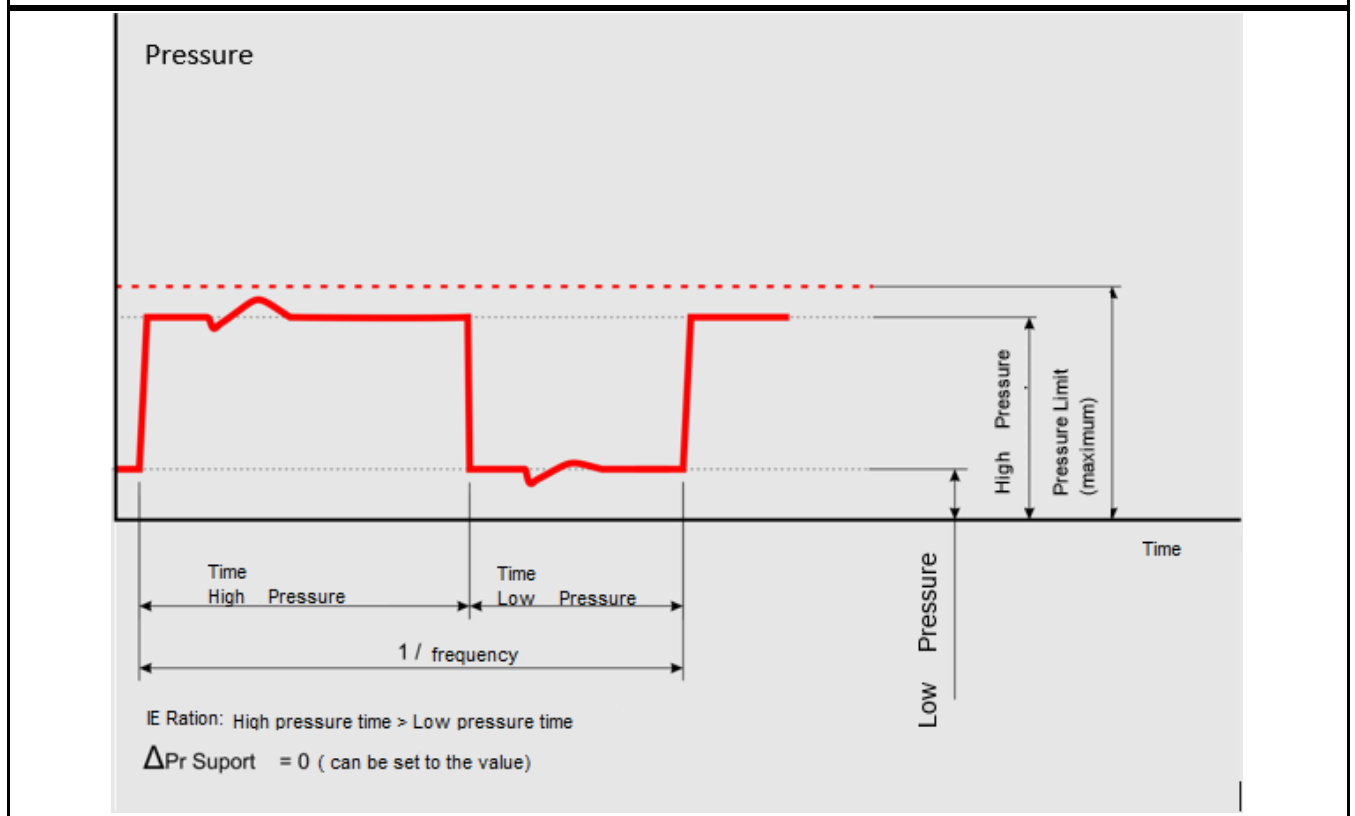

WARNING

- *The support pressure (ΔPS) is a value above the superior or inferior pressure. Therefore, the maximum support pressure will be the sum of that reference pressure and ΔPS .*
- *The default values are initial reference only.*
- *Readjust ventilation parameters as required by the patient.*

10.12.10 MMV

MMV – Spontaneous ventilation with mandatory minute volume	
<p>Description:</p> <p>In this semi-automatic mode, initially, the ventilator allows spontaneous test cycles with a support pressure of 5 or 10 cmH₂O above the adjusted PEEP.</p> <p>Then the minute volume is measured, and approximate compliance is calculated.</p> <p>For each subsequent cycle, the ventilator recalculates the compliance of the previous cycle and adjusts the pressure level to the next cycles, reaching the adjusted minute volume.</p> <p>The increase in pressure between the cycles never exceeds 3 cmH₂O and the maximum level reached does not exceed the value of the set limit pressure.</p> <p>If this value is reached, and the adjusted minute volume is not reached, the limited pressure alarm will be displayed.</p> <p>On the other hand, if the set apnea time is reached, the backup ventilation will be activated.</p> <p>The onset of inspiration occurs when the patient makes an effort that is recognized by the ventilator according to the adjusted trigger. If the backup is active and the patient goes into apnea, the onset of inspiration will occur according to the set apnea time. Cycle (transition between inspiration and expiration) occurs by flow as it falls to a certain percentage of its maximum reached value.</p>	<p>Adjusted Parameters:</p> <ul style="list-style-type: none"> • MINUTE VOLUME • PEEP • CYCLE (% FLOW) • PRESSURE TRIGGER • FLOW TRIGGER • O₂ CONCENTRATION • RISE TIME • LIMIT PRESSURE • BACKUP <ul style="list-style-type: none"> ○ VCV Backup <ul style="list-style-type: none"> ▪ VOLUME ▪ RATE ▪ FLOW ▪ FLOW WAVE ▪ PAUSE ○ PCV Backup <ul style="list-style-type: none"> ▪ CONTROL PR² / INSPIRATORY PRESSURE (Neonatal) ▪ RATE ▪ INSPIRATORY TIME <ul style="list-style-type: none"> ○ Automatic Backup⁽¹⁾ <p>1 – Whenever the set apnea time is reached, the ventilator triggers a ventilator cycle, the setting of which is based on the current mode settings.</p> <p>2- The controlled pressure setting (Pr Control) in pediatric or adult patients, refers to a relative pressure, that is, it adjusts the pressure value ABOVE PEEP.</p>

10.12.11 VS

VS - Spontaneous ventilation with assured volume

Description:

In this semi-automatic mode, Initially, the ventilator allows spontaneous test cycles with a support pressure of 5 or 10 cmH₂O above the adjusted PEEP.

Then the delivered volume is measured, and the approximate compliance is calculated.

For each subsequent cycle, the ventilator recalculates the compliance of the previous cycle and adjusts the pressure level for the next cycles, reaching the adjusted volume.

The increase in pressure between the cycles never exceeds 3 cmH₂O and the maximum level reached does not exceed the value of the set limit pressure.

If this value is reached, without the adjusted volume being reached, the limited pressure alarm will be displayed.

On the other hand, if the set apnea time is reached, the backup ventilation will be activated.

The onset of inspiration occurs when the patient makes an effort that is recognized by the ventilator according to the adjusted trigger. If the backup is active and the patient goes into apnea, the onset of inspiration will occur according to the set apnea time. Cycle (transition between inspiration and expiration) occurs by flow as it falls to a certain percentage of its maximum reached value.

Adjusted Parameters:

- VOLUME
- PEEP
- CYCLE (% FLOW)
- PRESSURE TRIGGER
- FLOW TRIGGER
- O₂ CONCENTRATION
- RISE TIME
- LIMIT PRESSURE
- BACKUP

- PRVC Backup
 - RATE
 - INSPIRATORY TIME

- Automatic Backup⁽¹⁾
1 – Whenever the set apnea time is reached, the ventilator triggers a ventilator cycle, the setting of which is based on the current mode settings.



WARNING

- ***The apnea time alarm can be turned off. In this condition, BACKUP VENTILATION WILL NEVER BE ACTIVATED.***
- ***If backup ventilation is turned off, the operator must be sure that this adjustment is necessary and aware of the clinical implications involved.***

10.12.12 Nasal CPAP

Nasal CPAP - Spontaneous ventilation with positive nasal airway pressure	
<p>Description:</p> <p>As in CPAP mode, in Nasal CPAP the ventilator allows the patient to breathe spontaneously, with the difference that the ventilator compensates for leaks automatically and ignores high minute volume, high current tidal and flow sensor verification.</p> <p>This mode is only available for neonatal patients and requires a compatible nasal interface.</p> <p>The onset of inspiration occurs when the patient makes an effort that is recognized by the ventilator according to the adjusted trigger. If the backup is active and the patient goes into apnea, the onset of inspiration will occur according to the set apnea time. Cycle (transition between inspiration and expiration) occurs by flow as it falls to a certain percentage of its maximum reached value.</p>	<p>Adjusted Parameters:</p> <ul style="list-style-type: none"> • PEEP / CPAP • O₂ CONCENTRATION • ΔPS (Support Pressure) • CYCLE (% FLOW) • RISE TIME • PRESSURE TRIGGER • FLOW • BACKUP <ul style="list-style-type: none"> ○ PLV-NEONATAL Backup <ul style="list-style-type: none"> ▪ INSP PRESSURE ▪ RATE ▪ INS TIME ○ Automatic Backup⁽¹⁾ <p>1 - Whenever the set apnea time is reached, the ventilator triggers a ventilator cycle, the setting of which is based on the current mode settings.</p>

10.12.13 NIV

NIV - Non-Invasive Ventilation	
<p>Description:</p> <p>As in CPAP mode, in NIV the ventilator allows the patient to breathe spontaneously, with the difference that the ventilator compensates for leaks automatically</p>	<p>Adjusted Parameters:</p> <ul style="list-style-type: none"> • PEEP / CPAP • O₂ CONCENTRATION • ΔPS (Support Pressure) • CYCLE (% FLOW) • RISE TIME • PRESSURE TRIGGER • FLOW (Neonatal) • BACKUP

NIV - Non-Invasive Ventilation

<p>and ignores the high minute volume, high current tidal and flow sensor verification.</p> <p>This mode is available to all patients.</p> <p>The onset of inspiration occurs when the patient makes an effort that is recognized by the ventilator according to the adjusted trigger. If the backup is active and the patient goes into apnea, the onset of inspiration will occur according to the set apnea time. Cycle (transition between inspiration and expiration) occurs by flow as it falls to a certain percentage of its maximum reached value.</p>	<ul style="list-style-type: none"> ○ VCV Backup <ul style="list-style-type: none"> ▪ VOLUME ▪ RATE ▪ FLOW ▪ LIMIT PRESSURE ▪ FLOW WAVE ▪ PAUSE ○ PCV Backup <ul style="list-style-type: none"> ▪ CONTROL PR²/INSPIRATORY PRESSURE (Neonatal) ▪ RATE ▪ INSP TIME ○ PLV-NEONATAL Backup <ul style="list-style-type: none"> ▪ INSP PRESSURE ▪ RATE ▪ INS TIME ○ Automatic Backup⁽¹⁾ <ul style="list-style-type: none"> 1 - Whenever the set apnea time is reached, the ventilator triggers a ventilator cycle, the setting of which is based on the current mode settings. 2 - The controlled pressure setting (Pr Control) in pediatric or adult patients, refers to a relative pressure, that is, it adjusts the pressure value ABOVE PEEP.
---	--

10.12.14 VG

VG - Guaranteed Volume Ventilation

<p>Description:</p> <p>Available only for neonatal patient, this ventilatory mode is similar to the PLV, except that a tidal volume value can be set to be delivered by the ventilator.</p> <p>The onset of inspiration (triggering) occurs according to the pre-established respiratory rate. Cycle (transition between inspiration and expiration) occurs by flow as it falls to a certain percentage of its maximum reached value.</p>	<p>Adjusted Parameters:</p> <ul style="list-style-type: none"> • INSPIRATORY PRESSURE • RATE • INSPIRATORY TIME • PEEP • O₂ CONCENTRATION • FLOW (\dot{V}) • PRESSURE TRIGGER • FLOW TRIGGER • VOLUME <p>Obs.: Automatic Backup⁽¹⁾ 1 - Whenever the set apnea time is reached, the ventilator triggers a ventilator cycle, the setting of which is based on the current mode settings.</p>
---	---



WARNING

- *This mode is only available in neonatal patient with proximal flow sensor.*
- *It is mandatory to perform auto test to enable this mode.*

10.12.15 O₂ THERAPY

O ₂ THERAPY	
<p>Description:</p> <p>Available for all patient types, this special mode offers continuous O₂ flush according the O₂ concentration and flow set. This mode requires a compatible interface.</p> <p>To use this mode, connect the appropriate breathing circuit and humidifier for the therapy following the circuit manufacturer's recommendations, put the Fleximag Max in stand-by mode, select the O₂ Therapy mode, perform the O₂ concentration and flow adjustments and take Fleximag Max out of stand-by mode to start therapy.</p>	<p>Adjusted Parameters:</p> <ul style="list-style-type: none">• FLOW• O₂ CONCENTRATION



WARNING

- **Connect the HIGH FLOW O₂ THERAPY breathing circuit with the HIGH FLOW NASAL CANNULA to the VENTILATOR'S FLOW OUTLET.**
- **Do not lubricate fittings, connections, tubing, or other accessories of the equipment to avoid the risk of fire and burns.**
- **Do not use sealed patient interfaces with this equipment, to avoid the risk of suffocation or barotrauma.**
- **Ensure a sufficient intended leakage between the breathing system and the patient to allow the patient to exhale.**
- **Do not allow open flames within 2 m of the equipment or any oxygen-carrying accessories. Open flames during oxygen therapy are dangerous and are likely to result in fire or death.**
- **Oxygen makes it easier for a fire to start and spread. Do not leave the nasal cannula or mask on bed coverings or chair cushions, if the equipment is turned on, but not in use; the oxygen will make the materials more flammable. Turn the equipment off when not in use to prevent oxygen enrichment.**
- **Smoking during oxygen therapy is dangerous and is likely to result in facial burns or death. Do not allow smoking or open flames within the same room as the equipment or any oxygen-carrying accessories. If the patient intends to smoke, always turn the equipment off, remove the cannula and leave the room where the equipment is located. If unable to leave the room, wait 10 minutes after you have turned the equipment off.**
- **The therapy supplied to the patient can be adversely affected by the gas added by the use of a pneumatic nebulizer.**

-
- *There is a risk of fire associated with oxygen enrichment during oxygen therapy. Do not use the equipment or accessories near sparks or open flames.*
 - *This equipment is only suitable for a spontaneously breathing patient.*
 - *Do not connect the equipment to the battery of a wheelchair battery-powered wheelchair as this can affect the equipment performance which consequently can result in degradation of health of the patient.*
 - *Do not use the equipment outside a temperature of 50°C. Using the equipment outside of this temperature range can compromise the equipment performance which consequently can result in degradation of the health of the patient.*
 - *To prevent disconnection of the tubing or tubing system during use, especially during ambulatory use, only use tubes with a retention force in conformance with ISO 5367 or ISO 80601-2-74.*
 - *To reduce the likelihood of disconnection and to prevent adverse equipment performance use only accessories compatible with the equipment. Compatibility is determined by reviewing the instructions for use of either the equipment or the accessories.*
 - *Use only spare parts recommended by the manufacturer to ensure proper function and to avoid the risk of fire and burns.*
 - *Only water-based lotions or salves that are oxygen-compatible before and during oxygen therapy. Never use petroleum-based or oil-based lotions or salves to avoid the risk of fire and burns.*
 - *Do not add any attachments or accessories to the equipment that contravene the instructions for use of the equipment or accessory, as the equipment might not function correctly leading to the risk of degradation of health of the patient.*
 - *The humidifier shall not be used with nitric oxide. Such use might cause the humidifier to not function correctly causing serious deterioration of health.*
 - *Covering breathing tubes with a blanket or heating them in an incubator or with an overhead heater can affect the quality of the therapy or injure the patient.*
 - *Use of the humidifier with a gas source (e.g. a blower/turbine based ventilator) that heats the gas provided to the humidifier above limit temperature can result in impaired humidification output with the potential to cause severe deterioration of health.*
 - *This ventilator is high-flow and should only be connected to a pipeline with a diversity factor considering its flow and the number of terminals. Failure to comply may result in equipment malfunction, compromised patient care and interferes with the operation of adjacent equipment.*
-

10.12.16 PRVC-SIMV

PRVC-SIMV – Volume-controlled synchronized intermittent mandatory ventilation with regulated pressure

<p>Description</p> <p>Available for adult and pediatric patients, this mode fixes the ventilator to the respiratory rate and is limited to the pressure that uses the tidal volume as feedback to continuously adjust the pressure limit, in addition to the sensitivity criteria for the occurrence of ventilator triggering for the patient .</p> <p>This mode allows the ventilator to apply the pre-determined mandatory cycles in synchrony with the inspiratory effort of the patient.</p> <p>The mandatory cycles run in a pre-determined time period (the start of inspiration occurs according to the pre-set respiratory rate), therefore synchronized with the patient's trigger.</p> <p>If there is an apnea, the next cycle will be triggered by the time until the inspiratory incursions of the patient return.</p> <p>In the mandatory cycles, the cycling (end of inspiration and start of expiration) occurs according to the inspiratory time. In spontaneous cycles, cycling (end of inspiration and start of expiration) occurs by flow, so that this falls at a certain percentage of its maximum value reached.</p> <p>To obtain the IMV in this mode, it is enough to deactivate the support pressure setting the support pressure equal to zero ($\Delta PS=0$) or the flow and pressure sensitivities equal to zero.</p> <p>The transition between inspiration and expiration in mandatory cycles occurs after the release of the pre-set tidal volume at the speed determined through the flow rate (either ratio or inspiratory time). In spontaneous cycles, cycling (transition between inspiration and expiration) occurs by flow, so that this falls at a certain percentage of its maximum value reached.</p>	<p>Adjustable parameters</p> <ul style="list-style-type: none"> • VOLUME • RATE • INSPIRATORY TIME • PEEP • LIMIT PRESSURE • O2 CONCENTRATION • RISE TIME • PRESSURE TRIGGER • FLOW TRIGGER • ΔPS (Support Press – PEEP) • CYCLAGE BY FLOW (% FLOW) <p>Obs.: Automatic backup(1)</p> <p>1 – Whenever the apnea time set is reached, the ventilator triggers a ventilation cycle, whose configuration is based on the settings of the current mode</p>
--	--

10.12.17 MASV

MASV - Magnamed Automated Support Ventilation	
Description <p>The MASV is an automated ventilation mode, with a closed loop, based on the Otis principle, which aims at a target minute volume, based on the variables Tidal Volume and Respiratory Rate, constantly analyzed for minimum respiratory work.</p> <p>The calculated parameters will be limited to a safe range of lung protection in order to prevent hyperventilation, hypoventilation, air trapping or volutrauma.</p> <p>The mode starts with 3 controlled test cycles, in PCV to analyze ventilation mechanics, including the patient's expiratory time constant and establishment of the ideal ventilation goal. The algorithm will always respect the safety limits established and easily visualized by the safety chart of the specific ventilation mode curve.</p> <p>The MASV makes adjustments to guide the patient's current values to the target point. This can be achieved for spontaneous or controlled breathing. Therefore, when the patient's condition reaches the target, the patient is considered optimally ventilated according to MASV.</p> <p>The MASV estimates the ideal breathing pattern based on the % of Minute Volume and the Predicted Weight (IBW), entered by the therapist, as well as the measured values of Expiratory Time Constant.</p> <p>When activating MASV mode, it is mandatory to enter the patient's height to calculate the predicted weight, as well as the % of the ideal minute volume that you wish to offer.</p>	Adjusted Parameters: <ul style="list-style-type: none">• % MINUTE VOLUME• O₂ CONCENTRATION• PEEP• PRESSURE TRIGGER• FLOW TRIGGER• RISE TIME• LIMIT PRESSURE• CYCLE (% FLOW)



WARNING

- ***This mode is not available in non-invasive ventilation.***

10.13 Oxygen adjustment response time

The table below indicates the time required for oxygen concentration in the delivered volume to change from a fraction of 21% to 90% of the maximum oxygen concentration adjustable using the maximum internal volume respiratory system configuration.

Table 22 – Oxygen adjustment response time

Delivered volume (mL)	Maximum response time (s)
500	98
150	83
30	360

10.14 Accuracy of settings

The following table shows the maximum error between the adjusted value and the value applied by the ventilator.

Table 23 – Accuracy of settings

Item	Parameter	Accuracy ^{1,2}
1	Tidal volume (All range) ¹	$\pm (4 \text{ mL} + 15\% \text{ of set volume})$
2	Inspiratory pressure	$\pm (2 \text{ cmH}_2\text{O} + 4\% \text{ of set pressure})$
3	PEEP	$\pm (2 \text{ cmH}_2\text{O} + 4\% \text{ of set PEEP})$
4	FiO ₂	$\pm (5\% + 2,5\% \text{ of set FiO}_2)$

1 The volume and pressure accuracy are preserved for respiratory circuits with resistance up to 1.9 cmH₂O and compliance up to 5 mL/cmH₂O

2 Performance accuracies were determined in the worst-case configuration, with respiratory circuit with water trap, heated humidifier, proximal flow sensor and CO₂ sensor, because they have greater compliance and a greater number of potential leakage points.

The performance accuracies were determined through a test system with the measurement uncertainties described in the table below:

Table 24 – Uncertainty of settings

Item	Parameter	Uncertainty
1	Tidal volume	± 2,5%
2	Inspiratory pressure	± 2,0%
3	PEEP	± 2,0%
4	FiO ₂	± 2,0%

10.15 Adjustable Parameter Specifications

Table 25 - Adjustable parameters

Item	Parameter	Specification	Resolution		Unit
1	Tidal volume	2.0 to 3000	Neonatal ⁽¹⁾	2.0 to 10.0: 0.1	mL
				10 to 99: 1	
			Pediatric	10 to 100: 5	
				100 to 300: 10	
			Adult	100 to 1000: 10	
				1000 to 3000: 50	
2	Respiratory rate ⁽²⁾⁽³⁾	0 to 200	Neonatal	0 to 200: 1	rpm
			Pediatric	0 to 200: 1	
			Adult	0 to 100: 1	
3	Rise time	0 to 2.0	0.1		s
4	Pause (plateau)	0 to 70	10		%
		0 to 2	0.1		s
5	Inspiratory pressure and limit	0 to 120	1		cmH ₂ O
6	ΔPS	0 to 120	1		cmH ₂ O
7	PEEP	0 to 50	1		cmH ₂ O
8	Pressure trigger	OFF, 0.2 to -20	0.2 to -2.0: - 0.2		cmH ₂ O
			-2 to -20: - 1		
9	Flow trigger	OFF, 0.1 to 30	0.1 to 1.0: 0.1		L/min

Item	Parameter	Specification	Resolution	Unit
			1.0 to 30.0: 0.5	
10	Cycle	5 to 80 (maximum 3 s)	5	%
11	O ₂ Concentration	21 to 100	1	% vol
12	Inspiratory time	0.05 to 30	0.05 to 0.70: 0.01	s
			0.70 to 1.00: 0.05	
			1.0 to 30.0: 0.1	
13	Flow waveform	Square, Descending or Decelerating, Ascending or Accelerated, Sinusoidal	---	---
14	CPAP	0 to 50	1	cmH ₂ O
15	Superior Pressure (DualPAP/APRV)	5 to 90	1	cmH ₂ O
16	Inferior Pressure (DualPAP/APRV)	0 to 45	1	cmH ₂ O
17	Superior Time (DualPAP/APRV)	0.10 to 59.8	0.10 to 0.70: 0.01	s
			0.70 to 1.00: 0.05	
			1.00 to 59.80: 0.10	
18	Inferior Time (DualPAP/APRV)	0.20 to 59.9	0.20 to 0.70: 0.01	s
			0.70 to 1.00: 0.05	
			1.00 to 59.90: 0.10	
19	Ratio I: E	1:599 to 299:1 ⁽³⁾	1:0.1	---
20	Backup ⁽⁴⁾	OFF, PLV, PCV, VCV and PRVC	---	---
21	Inspiratory flow ⁽¹¹⁾	1 to 180	1	L/min
22	Patient Height	64 to 132 ⁽⁸⁾ (Pediatric)	1	cm
		133 to 250 (Adult) ⁽⁸⁾	1	cm
23	Patient weight	0,1 to 5,9 (Neonatal)	0,1	kg
24	Nebulizer flow - 100% oxygen ⁽⁵⁾	5 to 8 (without direct adjustment)	---	L/min
	Nebulization time	1 to 50	1	min
25	TGI (Tracheal Gas Insufflation) Flow - 100% Oxygen ⁽⁵⁾	5 to 8 (without direct adjustment)	---	L/min

Item	Parameter	Specification	Resolution	Unit
26	Sigh ⁽⁶⁾	1 to 3	1	gasp
27	Volume of the sigh ⁽⁶⁾	10 to 100	10	% Vt
28	Rate of the sigh ⁽⁶⁾	20 to 100	10	cycles
29	Tube compensation	Endotracheal Tracheostomy	---	---
30	Diameter of the tube ⁽¹²⁾	2.5 to 12.0	2.5 to 10 : 0.5	mm
			10 to 12 : 1	
31	% Tube Compensation	10 to 100	10	%
32	Minimum inspiratory hold ⁽⁷⁾	0,1 to 30	0,1 to 1 : 0.1	s
	Minimum expiratory hold		1 to 30 : 1	
33	Alarm muting time	10 to 120	10	s
34	Screen Lock Time	OFF, 1 to 30	1 to 5: 1	min
			10 to 30: 5	
35	Flow (only in O ₂ Therapy mode) ⁽¹³⁾	0 to 60	0 to 60: 1	L/min
36	Minute Volume (MMV)	1,0 a 50,0	0,1	L
37	Flow (neonatal)	1 a 40	1	L/min
38	FiO ₂ (O ₂ + flush)	50 a 100	1	%
39	Time (O ₂ + Flush)	10 a 120	1	s
40	Alarm silence	10 a 120	1	s
41	Minute Volume	50 a 350	1	%

- (1) Neonatal patient volume only with NEONATAL proximal flow sensor and in VG mode.
- (2) Respiratory rate 0 (zero) will only be reached in spontaneous modes, with triggers and backup off.
- (3) The minimum and maximum values of rate and I: E ratio depend on the adjusted ventilatory mode.
- (4) Adjustable backup options for spontaneous modes, for other modes, backup is automatic.
- (5) Nebulizer and TGI flows cannot be activated simultaneously.
- (6) Sigh adjustment available only in VCV and V-SIMV modes
- (7) Hold time when immediately pressing and releasing button.
- (8) The weight of the adult and pediatric patient considered by the equipment for parameter adjustment is the ideal weight (IBW), calculated according to the height of the patient.
- (9) The adjustment above 180 rpm is indirectly obtained by adjusting upper and lower time in DualPAP.

-
- (10) In controlled modes, P_{insp} can be adjusted from 5 to 120 cmH₂O. In spontaneous mode (CPAP/PS), PS is equal to P_{insp} and can be adjusted from 0 to 120 cmH₂O.
- (11) Adult patient – 1 to 180 L/min, Pediatric patient 1 to 100 L/min.
- (12) Adult patient – 6 to 12.0 mm, Pediatric patient 3.5 to 7.0 mm, Neonatal patient 2.5 to 3.5 mm
- (13) Adult patient – 0 to 60 L/min, Pediatric and Neonatal patient – 0 to 30 L/min



ATTENTION

- *The FlexiMag Max ventilator cares for any patient, from premature to morbidly obese, however, the patient height adjustment used for optimal weight calculation is limited.*
- *For patients who exceed this limit, the parameters can be adjusted directly by the operator.*

10.16 Monitored Parameter Specifications

The monitored parameters are calculated using the ordinary least squares (OLS) technique, which calculates the mean through the most recent values in a data series. Thus, for each value included in the averaging calculation, the oldest value is excluded.

Table 26 - Monitored ventilatory parameters

Parameter	Range	Resolution	Measurement Accuracy ⁽¹⁾
Instantaneous pressure	0 to 120 cmH ₂ O	1	± (2 cmH ₂ O + 4% of reading)
Peak pressure (P _{peak})	0 to 120 cmH ₂ O	1	± (2 cmH ₂ O + 4% of reading)
Mean pressure (P _{mean})	0 to 120 cmH ₂ O	1	± (2 cmH ₂ O + 4% of reading)
Plateau Pressure (P _{plat})	0 to 120 cmH ₂ O	1	± (2 cmH ₂ O + 4% of reading)
PEEP ⁽⁷⁾	0 to 120 cmH ₂ O	1	± (2 cmH ₂ O + 4% of reading)
Intrinsic PEEP (iPEEP) ⁽⁷⁾	0 to 99.9 cmH ₂ O	1	± (2 cmH ₂ O + 4% of reading)
Measured Flow ^{(4) (5) (6)}	-180 to 180 L/min	1	± (50mL/min + 10 % of reading)
Tidal Volume in Volume Guaranteed (V _{te}) ^{(2) (3) (4)}	0.0 to 10.0 mL	0.1	±(4,0 mL + 15% of reading)
	10 to 100 mL	1	
Tidal volume (V _{te}) ^{(3) (4) (5)}	0 to 999 mL	1	±(4,0 mL + 15% of reading)
	1,00 to 3,00 L	0.01	
Total minute volume (MV) ^{(4) (5)}	0.001 to 0.999 L	0.001	±(4,0 mL + 15 of reading)
	1.00 to 9.99 L	0.01	
	10.0 to 99.9 L	0.1	
Inspiratory time	0.05 to 9.99 s	0.01	± (0,10 s + 10% of reading)
	10.0 to 60.0 s	0.1	± (0,10 s + 10% of reading)
Expiratory time	0.05 to 9.99 s	0.01	± (0,10 s + 10% of reading)
	10.0 to 60.0 s	0.1	± (0,10 s + 10 of reading)
I:E Ratio	1:599 to 599:1	1:0.1	± (0,1 + 10 % of reading)
Total respiratory rate	0 to 200 bpm	1	± (1bpm + 10% of reading)

Parameter	Range	Resolution	Measurement Accuracy ⁽¹⁾
Spontaneous respiratory rate	0 to 200 bpm	1	± (1bpm + 10% of reading)
O ₂ Concentration (O ₂)	12,0 to 99.9 %	0.1	± (2,5% + 2,5% of reading)
	100 to 110 %	1	
Airway Resistance ⁽³⁾ (Ri and Re)	0 to 99.9 cmH ₂ O/L/s	0.1	± (5cmH ₂ O/L/s +20% of reading)
	100 to 200 cmH ₂ O/L/s	1	
Dynamic Compliance	0 to 99.9 mL/cmH ₂ O	0.1	± (1mL/cmH ₂ O + 10% of reading)
	100 to 200 mL/cmH ₂ O	1	
Static Compliance	0 to 99.9 mL/cmH ₂ O	0.1	± (1mL/cmH ₂ O + 10% of reading)
	100 to 200 mL/cmH ₂ O	1	
Auxiliary pressure	0 to 120 cmH ₂ O	1	± (2 cmH ₂ O + 4% of reading)
Estimated tracheal pressure	0 to 120 cmH ₂ O	1	± (2 cmH ₂ O + 4% of reading)
Elastance	0 to 999 cmH ₂ O/L	1	± (1cmH ₂ O/L + 10% of reading)
Leakage flow ⁽⁴⁾	0.0 to 19.9 L/min	0.1	± (50mL/min + 10% of reading)
	20 to 180 L/min	1	
Percentage leakage ⁽⁴⁾	0 to 100 %	1	± (10% + 10% of reading)
Time constant (TC) ⁽⁵⁾	Calculated (s)	0.1	± (0,1s + 10% of reading)
Ti / Ttotal	Calculated (s)	0.1	± (0,1s + 10% of reading)
RSBi - Surface Respiration Index (IRRS, Tobin Index)	Calculated (cycles/min/L)	1	± (1 cycle/min/L + 10% of reading)
WOBi (Respiratory work imposed)	Calculated (J/min)	0.01	± (0,1 J/min + 10% of reading)
WOBi (Respiratory work imposed)	Calculated (J/L)	0.01	± (0,1 J/L + 10% of reading)
Pi Max	-60 to 120 cmH ₂ O	1	± (2 cmH ₂ O + 4% of reading)
Driving Pressure	Calculated (Pplateau – PEEP)	1	± (2 cmH ₂ O + 4% of reading)
O ₂ consumption	0 to 180 L/min	0.1	± (50mL/min + 10% of reading)
P0.1	-60 to 0 cmH ₂ O	0,1	± (2 cmH ₂ O + 10% of reading)

Parameter	Range	Resolution	Measurement Accuracy ⁽¹⁾
Maximum inspiratory flow	0,0 a 9,9 L/min	0,1	± (0.01 L/min + 10% of reading)
	10 to 180 L/min	1	± (50mL/min + 10% of reading)
Maximum expiratory flow	-9,9 to 0 L/min	0,1	± (50mL/min + 10% of reading)
Stress index	0,00 to 2,00	0,01	± (0.01 + 10% of reading)
C20/C	0,00 to 5,00	0,01	± (0.2 + 10% of reading)
Inspiratory volume/weight	0 to 99,9 L/min	0,1	± (4 mL + 15% of reading)
Expiratory volume/weight	0 to 99,9 L/min	0,1	± (4 mL + 15% of reading)
P0.1	-60 to 0 cmH2O	0,1	±(2cmH2O or 10% of reading)
Flow peak insp	0,0 a 9,9 L/min	0,1	± (0,01 L/min + 10% of reading)
	10 to 180 L/min	1	± (50 mL/min + 10% of reading)
Flow peak exp	-9,9 to 0 L/min	0,1	± (50 mL/min + 10% of reading)
Stress index	0,00 to 2,00	0,01	± (0,01 + 10% of reading)
C20/C	0,00 to 5,00	0,01	± (0,2 + 10% of reading)
Volume/Weight inspiratory	0 to 99,9 L/min	0,1	± (4,0 mL + 15% of reading)
Volume/Weight expiratory	0 to 99,9 L/min	0,1	± (4,0 mL + 15% of reading)
Anatomical Dead Space Ventilation (VDaw)	0 to 999 mL	1	Calculated
	1 to 3 L	0,01	
Anatomical Dead Space Ventilation per Volume Tidal Expiratory (VDaw/VTE)	0 to 110%	1	Calculated
Alveolar Tidal Volume (Vtalv)	0 to 999 mL	1	Calculated
	1 to 3 L	0,01	
Alveolar Minute Volume (V'alv)	0,001 to 0,999 mL	0,001	Calculated
	1 to 9,9 L	0,01	
	10 to 99,9 L	0,1	
Expired CO ₂ Volume (VeCO ₂)	0 to 999 mL	1	± (4,0 mL + 15% of reading)
	1 to 3 L	0,01	
Volume of CO ₂ expelled / Breath (VCO ₂)	0 to 999 mL	1	± (4,0 mL + 15% of reading)
	1 to 3 L	0,01	
Volume of CO ₂ eliminated / minute (V'CO ₂)	0,001 to 0,999 mL	0,001	Calculated
	1 to 9,9 L	0,01	
	10 to 99,9 L	0,1	
CO ₂ Mean Alveolar Partial Pressure (PACO ₂)	0 to 189 mmHg	1	Calculated

Parameter	Range	Resolution	Measurement Accuracy ⁽¹⁾
Partial Pressure of CO ₂ in Exhaled Gas (PETCO ₂)	0 to 189 mmHg	1	± (2,25 mmHg + 4% of reading)
Volume inspired of CO ₂ (ViCO ₂)	0 to 999 mL	1	± (4 mL + 15% of reading)
	0,01 to 1,00 L	0,01	
Fractional Concentration of CO ₂ in Exhaled Gas (FetCO ₂)	0 to 110%	1	Calculated
CO ₂ slope (slopeCO ₂)	0,00 to 9,99 % CO ₂ /L	0,01	Calculated

- (1) When two tolerances are indicated, consider the one with the highest value. The accuracy of volume and pressure is preserved for respiratory circuits with resistance up to 1.9 cmH₂O and compliance up to 5 mL / cmH₂O. The accuracies values are applied to all types of breathing circuits described in the manual.
- (2) Only in VG mode.
- (3) For airway resistance greater than 150 cmH₂O / L / s, the expired volume will have its tolerance outside the declared. In this condition, the measured inspiratory volume remains unchanged.
- (4) Volumes, flows and leakage specifications associated with the ventilator respiratory system are expressed in BTPS.
- (5) Inspired and expired monitored.
- (6) Flow obtained from the FlowAir system or the gas network.
- (7) Total PEEP is displayed on the bargraph during the expiratory pause, obtained by adding PEEP + iPEEP.



WARNING

- **Ventilation with cyclic pressure up to 100 cmH₂O can add tolerance error of up to 2%.**
- **The accuracy of the parameters can be affected under the following conditions:**
 - **Reuse of single-use accessories;**
 - **Incorrect sensor uses for patient type;**
 - **Secretion in the circuit and flow sensor;**
 - **Leakage in the circuit;**
 - **Oxygen cell and flow sensor not calibrated;**
 - **Condensation in the circuit, flow sensor and gas inlet;**
 - **Use of nebulizer with the capnography sensor;**
 - **Proximal flow sensor with tubes facing down.**
- **To maintain the accuracy, keep the flow sensor, breathing circuit, and gas inlet dry, clean, and non-condensing.**

Observations

- *In practice, the units of measure of pressure are equivalent, being able to adopt that 1 mbar = 1 hPa ≈ 1 cmH₂O.*
 - *Oxygen monitoring is obtained accurately in up to 20 seconds after initialization.*
-

10.17 Safety System Specifications

- Anti-asphyxia valve for protection against gas supply failure.
- Safety relief valve of 100 cmH₂O, according to basic ventilator norm in order to avoid overpressure in the respiratory circuit.
- Active overpressure valve that, when detecting obstructions, is activated to reduce the pressure in the respiratory circuit.
- High Pressure Relief Valve is activated when the mains pressure is above 800 kPa (8.0 kg / cm²) by sending the excess gas into the atmosphere. This will limit the ventilator supply pressure.

10.18 Alarm System Specification

The alarm priority is determined by the device's risk management process.

Table 27 - Alarm Priority

Potential result of failure to respond to alarm cause	Potential Damage Onset ⁽¹⁾		
	Immediate ⁽²⁾	Promptly ⁽³⁾	Late ⁽⁴⁾
Death or Irreparable injury	HIGH PRIORITY	HIGH PRIORITY	MEDIUM PRIORITY
Repairable injury	HIGH PRIORITY	MEDIUM PRIORITY	-
Mild injury or discomfort	MEDIUM PRIORITY	-	-

(1) Initiation of potential damage refers to the occurrence of the lesion and not to its manifestation

(2) There is potential for the event to develop over a period usually not enough for manual corrective action.

(3) There is potential for the event to develop over a period usually enough for manual corrective action.

(4) There is potential for the event to unfold in an unspecified period greater than that provided at the "prompt".

In this alarm system there is no change in the priority of the alarm condition and in the occurrence of more than one alarm simultaneously:

- High priority alarm messages are displayed alternately.
- In the absence of high priority alarms, the medium priority alarm messages will be displayed alternately

Alarm messages are displayed as soon as the alarm condition is detected, so there is no delay in displaying the messages.

Table 28 - Alarms Characteristics

Alarm	Characteristic	High priority	Medium Priority	Low Priority
Visual	Color	Red	Yellow	Cyan
	Intermittent frequency	2,08 Hz	0,47 Hz	Constant
Sound	Number of saved pulses	10 pulses	3 pulses	2 wrists
	Interval between saved	5,9 s	6,0 s	30.7s
	Sound pressure range	76,83 dBA	75,71 dBA	73.44 dBA
	Pulse frequency	301 Hz	301 Hz	301 Hz

Observations

- To identify the occurrence of an alarm, the operator should preferably be 1 meter from the front of the equipment at an angle of 30 ° with the horizontal axis at the center of the monitor's viewing plane.

10.18.1 Adjustable alarm specifications

Table 29 - Adjustable alarms

Alarm	Adjustment	Limit	Default Values ⁽¹⁾			Unit
			Neonatal	Pediatric	Adult	
Maximum Pressure	5 to 120	High	30	30	40	cmH2O
	OFF, 0 to 119	Low	OFF	OFF	OFF	
PEEP	OFF, 1 to 80	High	10	15	20	cmH2O
	OFF, 1 to 79	Low	OFF	OFF	OFF	
Total Volume	OFF, 10 to 3000	High	50 mL	500 mL	1.0 L	L or mL

Alarm	Adjustment	Limit	Default Values ⁽¹⁾			Unit
			Neonatal	Pediatric	Adult	
	OFF, 0 to 2950	Low	OFF	OFF	OFF	
Minute volume	OFF, 0.1 to 99.0	High	1.0	10	20	L
	OFF, 0.0 to 98.9	Low	0.5	2	3.6	
Respiratory rate	OFF, 1 to 200	High	80	60	60	rpm
	OFF, 0 to 199	Low	5	5	5	
O ₂	OFF, 19 to 100	High	80	80	80	%
	OFF, 18 to 99	Low	OFF	OFF	OFF	
EtCO ₂ ⁽²⁾	OFF, 1 to 80	High	45	45	45	mmHg
	OFF, 0 to 79	Low	OFF	OFF	OFF	
CO ₂ Ins ⁽²⁾	OFF, 0 to 80	High	3	3	3	mmHg
Heart rate ⁽²⁾	OFF, 1 to 240	High	150	120	100	bpm
	OFF, 0 to 239	Low	OFF	OFF	OFF	
SpO ₂ ⁽²⁾	OFF, 0 to 100	Low	85	85	85	%
Apnea	OFF, 1 to 60		15	15	15	s
Automatic ⁽³⁾	OFF, 10, 20 and 30		OFF	OFF	OFF	%
Driving pressure	OFF, 1 to 120	Alto	OFF	OFF	OFF	cmH ₂ O
	OFF, 1 to 119	Baixo	OFF	OFF	OFF	cmH ₂ O
Apnea sensitivity	OFF, 0,2 to 10		0,5	0,5	0,5	cmH ₂ O
Disconnection sensitivity	OFF, 5 to 90%		OFF	OFF	OFF	%

- (1) Whenever the equipment is started, or the patient type is changed, or the battery power is drained without the ventilator being connected to the power supply, the alarms will reset to default values.
- (2) Alarms available only with optional external sensors.
- (3) The alarm limits will be adjusted according to the monitored values. Valid only for basic ventilation alarms (maximum pressure, PEEP, volume, minute volume, rate and FiO₂).
- (4) The high maximum pressure alarm setting is limited by the pressure setting (limit pressure, upper pressure, controlled pressure and inspiratory pressure) of the current ventilation mode. In order to adjust the alarm with values lower than the allowed limit, it is necessary to adjust the ventilation mode pressures.

WARNING

- **Alarms will return to default values whenever the device restarts or the patient changes.**
- **The apnea time can be turned off and, in this condition, there will be no backup ventilation.**
- **THE OPERATOR SHALL BE AWARE OF THE RISKS OF KEEPING THE APNEIA ALARM OFF.**
- **Automatic alarm adjustment is based on the monitored values, so it can only be used when the ventilator is NOT in the STAND BY mode and preferably when the parameters**

are stable.

- **Adjusting the alarm limits to extreme values will make the alarm system useless.**

10.18.2 Ventilator alarm messages

In the event of one or more ventilator-related alarms, the following messages may be displayed, depending on their respective priorities:

Table 30 - High priority alarms

High priority alarm	Delay	Description
INOPERATIVE EQUIPMENT	< 1 second	Indicates that there was a technical failure in the equipment that needs to be replaced.
LOW BATTERY	< 1 second	When the internal battery charged is at its end. Appropriate means of ventilatory support of the patient should be provided.
APNEA	< 1 second	Means that the time elapsed since the last inspiration is greater than the alarm value set as the maximum apnea time.
LOW O₂ SUPPLY PRESSURE	< 1 second	The oxygen network pressure is below the specified range. This alarm will not be triggered if the O ₂ % parameter is at 21% (air) and the airline is operating within the required specifications.
LOW AIR SUPPLY PRESSURE	< 1 second	The air network pressure is below the specified range. This alarm will not be triggered if the O ₂ % parameter is at 100% and the Oxygen network is operating within the required specifications.
COMMUNICATION FAILURE	< 1 second	Indicates that there was a technical failure in the equipment that needs to be replaced.
OBSTRUCTION	< 2 cycles	There is some obstruction in the respiratory circuit that prevents the patient's complete or adequate expiration.
DISCONNECTED	< 5 cycles	There was disconnection of the respiratory circuit or flow sensor lines (if any), which prevents adequate ventilation of the patient.
HIGH PRESSURE	< 2 cycles	The pressure reached exceeded the alarm value set as the upper pressure limit.
LOW PRESSURE	< 2 cycles	The pressure did not reach the alarm value set as the lower pressure limit.
CHECK INTERNAL SENSOR	< 1 second	Indicates that there was a technical failure in the equipment that needs to be replaced.
CHECK BATTERY	< 1 second	Indicates that there may be an issue with the battery.
HIGH VOLUME	< 3 cycles	The patient volume exceeded the alarm value set as its upper limit.
LOW VOLUME	< 3 cycles	The patient volume is below the alarm value set as its lower limit.
FLOWAIR: VERY HIGH TEMPERATURE ¹	< 1 second	Indicates that the temperature of the FlowAir system is too high.

¹ Only for Fleximag Max 300 and Fleximag Max 700 models

High priority alarm	Delay	Description
FLOWAIR: FAILURE ¹	< 1 second	Indicates a failure in the FlowAir system
FIO₂ BELOW 18%	< 3 cycles	The inspired fraction of O ₂ is less than 18%.
SYSTEM RECOVERY	< 21 second	It is activated when the control software restarts without modifying any of the parameters and ventilation continues without interruption. The total system reboot time is < 21 seconds.

Table 31 - Medium Priority Alarms

Medium priority alarm	Delay	Description
LIMITED PRESSURE	< 1 second	When the monitored pressure reaches the set maximum pressure. The volume delivered by the ventilator module does not reach the adjusted volume due to the pressure limitation.
CHECK FLOW SENSOR	< 3 cycles	indicates that the flow sensor is disconnected. In these conditions all the monitoring that depends on this sensor (VT, MV, Rate, Vins, Tinsp, I: E, T exp, C stat, C dyn, Res, τ , iT, Volume Leak, VxTime Chart) will NOT be displayed. In volume-controlled ventilation modes, delivered volumes of the equipment will vary by up to \pm 10%.
HIGH PEEP	< 3 cycles	The positive end expiratory pressure (PEEP) exceeded the alarm value set as its upper limit.
LOW PEEP	< 3 cycles	The positive end expiratory pressure (PEEP) did not reach the alarm value set as its lower limit.
HIGH MINUTE VOL	< 3 cycles	The minute volume delivered to the patient exceeded the alarm value set as its upper limit.
LOW MINUTE VOL	< 3 cycles	The minute volume delivered to the patient is below the alarm value set as its lower limit.
HIGH RATE	< 3 cycles	The respiratory rate of the patient exceeded the alarm value set as their upper limit.
LOW RATE	< 3 cycles	The respiratory rate of the patient did not reach the alarm value set as their lower limit.
HIGH LEAKAGE	< 2 cycles	The measured leakage flow has exceeded the maximum compensation limit.
HIGH O₂ SUPPLY PRESSURE	< 1 second	Indicates that the network pressure is above the specified value.
HIGH AIR SUPPLY PRESSURE	< 1 second	Indicates that the network pressure is above the specified value.
HIGH DRIVING PRESSURE	< 2 cycles	The driving pressure exceeded the alarm value set as the upper limit of the driving pressure.
LOW DRIVING PRESSURE	< 2 cycles	The expired driving pressure is below the alarm value set as the lower limit of the driving pressure.
HIGH FIO₂	< 3 cycles	The inspired fraction of O ₂ has exceeded the alarm value set as its upper limit.
LOW FIO₂	< 3 cycles	The inspired fraction of O ₂ did not reach the alarm value set as its lower limit.
LOW BATTERY	< 1 second	The battery is less than half of its total capacity.
INVERTED I:E RATIO	< 1 second	It indicates that the ratio I: E is inverse, i.e., the time of the inspiratory phase is greater than the time of the expiratory phase.

Medium priority alarm	Delay	Description
ASSURED VOLUME NOT REACHED	< 1 second	The adjusted volume could not be reached.
FLOWAIR: HIGH TEMPERATURE¹	< 1 second	Indicates that the temperature of the FlowAir system is increasing.
HIGH TEMPERATURE	< 1 second	It indicates that the environmental condition is above 50 °C
O2 CELL FAILURE	< 1 second	It indicates that the O2 cell voltage is below 0.8 V

Table 32 - Low priority alarms

Low priority alarm	Delay	Description
APNEA WITH BACKUP	< 1 second	Indicates that apnea occurred and triggered a backup ventilation because there was one available or enabled.
NO AC POWER	< 1 second	Indicates that the ventilator is disconnected from the electrical network.
LOW AIR SUPPLY PRESSURE	< 1 second	The air network pressure is below the specified range and the flowair system was activated.
MASV: UNAVAILABLE GOAL	< 1 second	It is activated when it is not possible with the current parameter configuration to reach the minute volume configured in MASV mode
SYSTEM RECOVERY	< 21 second	It is activated when the HMI software restarts without modifying any of the parameters and ventilation continues without interruption. The total system reboot time is < 21 seconds.



WARNING

- *When receiving alarm information, promptly provide service to resolve the problem.*
- *Once the situation that requires the total silence of the audible alarm is terminated, the alarms shall be reactivated for patient safety.*



ATTENTION

- *To silence the audible alarm, press the MUTE button. Audible alarms will be disabled for the set period or until a new alarm occurs.*
- *It may be dangerous if different alarm pre-configurations are used for the same or similar equipment in the same area, such as an intensive care unit or cardiac surgery room.*
- *The equipment will always start with the audio volume set to the maximum level (6) regardless of the level set when it was turned off.*

¹ Only for Fleximag Max 300 and Fleximag Max 700 models

- *If an alarm occurs and the audio volume is set to a value below the maximum level (6), the volume will increase gradually every 15 seconds until it reaches its maximum limit.*

10.18.3 Ventilator Alert Messages

In the event of one or more ventilator related alerts, the following messages may be displayed:

Table 33 - Alert messages

Message	Delay	Description
ASSIST TRIGGER: FLOW	< 1 second	Indicates the occurrence of an assisted trigger, generated by increased inspiratory flow.
ASSIST TRIGGER: PRESSURE	< 1 second	Indicates the occurrence of an assisted trigger, generated by a pressure drop.
MANUAL TRIGGER	< 1 second	Indicates the occurrence of an assisted trigger, generated manually by the operator.
SPONT TRIGGER: FLOW	< 1 second	Indicates the occurrence of a spontaneous trigger, caused by increased inspiratory flow.
SPONT TRIGGER: PRESSURE	< 1 second	Indicates the occurrence of a spontaneous trigger, generated by a pressure drop.
SPONT TRIGGER: MANUAL	< 1 second	Indicates the occurrence of a spontaneous trigger, generated manually by the operator.
TO VENTILATE, HOLD STANDBY	< 1 second	Indicates that the unit is in standby and the button must be used to resume ventilation.
CO₂: CONNECTED	< 1 second	CO ₂ monitoring is active.
VENTILATION LOCKED	< 1 second	Indicates that the settings are locked to prevent accidental changes. If any adjustments need to be made the lock button must be pressed.
AUTOTEST LEAK FAILED	< 1 second	Indicates that the leak test has not been performed or the leak is above the tolerated limit.
ACTIVE SIGH	< 1 second	Sigh feature is enabled.

10.18.4 IRMA CO₂ sensor alarm messages

In the event of one or more alarms related to the IRMA CO₂ sensor, the following messages may be displayed, according to their respective priorities:

Table 34 - High priority alarms

High priority alarm	Delay	Description
HIGH EtCO₂	< 3 seconds	The expired CO ₂ rate exceeded the alarm value set as the upper limit of EtCO ₂ .
LOW EtCO₂	< 3 seconds	The expired CO ₂ rate is below the alarm value set as the lower limit of EtCO ₂ .

High priority alarm	Delay	Description
HIGH ICO₂	< 3 seconds	The inspired CO ₂ rate exceeded the alarm value set as the upper limit of CO ₂ l.
CO₂: APNEA	< 3 seconds	Indicates that the capnograph sensor is connected and the time elapsed since CO ₂ expiration is greater than 15 seconds of the maximum apnea time.

Table 35 - Medium Priority Alarms

Medium Priority Alarm	Delay	Description
CO₂: ZERO REQUIRED	< 3 seconds	Indicates the need to reset the IRMA CO ₂ sensor.
CO₂: OUT OF RANGE	< 3 seconds	Indicates that the CO ₂ reading is incorrect or inaccurate.
CO₂: PARAMETER OUT OF RANGE	< 3 seconds	Indicates that some parameter is outside the specified range and prevents the correct reading of CO ₂ .
CO₂: SPEED ERROR	< 3 seconds	Problem with the CO ₂ motor sent by Phase In.
CO₂: CALIBRATION LOST	< 3 seconds	Problem with factory calibration of CO ₂ sent by Phase In.

Table 36 - Low priority alarms

Low priority alarm	Delay	Description
CO₂: DISCONNECTED	< 3 seconds	CO ₂ monitoring was interrupted during use.
CO ₂ : REBOOT IRMA	< 3 seconds	Indicates that the CO ₂ sensor must be disconnected and reconnected.
CO ₂ : HARDWARE ERROR	< 3 seconds	Indicates that the CO ₂ sensor must be replaced.
CO ₂ : REPLACE ADAPTOR	< 3 seconds	Indicates that the airway adapter should be replaced.
CO ₂ : NO ADAPTOR	< 3 seconds	Indicates that the airway adapter must be properly connected.

Table 37 - Messages

Message	Delay	Description
CO₂: CONNECTED	< 3 seconds	Indicates that the CO ₂ sensor was connected



WARNING

- *When receiving alarm information, promptly provide service to resolve the problem.*
- *Once the situation that requires the mute of the audible alarm is terminated, the alarms shall be reactivated for patient safety.*

ATTENTION

- *It may be dangerous if different alarm pre-configurations are used for the same or similar equipment in the same area, such as an intensive care unit or cardiac surgery room.*
-

10.18.5 Oximeter Alarm Messages

In the event of one or more alarms related to the oximeter, the following messages may be displayed, according to their respective priorities:

Table 38 - High priority alarms

High priority alarm	Delay	Description
HIGH PULSE	< 3 seconds	The patient's heart rate exceeded the alarm value set as the upper limit.
LOW PULSE	< 3 seconds	The patient's heart rate is below the alarm value set as the lower limit.
LOW SpO₂	< 3 seconds	The saturation rate of O ₂ is below the alarm value set as the lower limit of SpO ₂ .
SPO2: CABLE LIFE EXPIRED	< 3 seconds	The patient cable is non-functional or the life of the cable has expired
SPO2: INCOMPATIBLE CABLE	< 3 seconds	The currently connected cable is not a proper cable
SPO2: UNRECOGNIZED CABLE	< 3 seconds	The currently connected cable is not being recognized
SPO2: DEFECTIVE CABLE	< 3 seconds	The currently connected cable is defective and unable to be used.
SPO2: CABLE LIFE NEAR EXPIRATION	< 3 seconds	Patient cable has less than 10% of active monitoring life remaining.
SPO2: SENSOR LIFE EXPIRED	< 3 seconds	Sensor has used all its available monitoring time.
SPO2: INCOMPATIBLE SENSOR	< 3 seconds	Not a proper Masimo® sensor. Sensor is attached to a device without an appropriate parameter installed.
SPO2: CHECK CABLE AND SENSOR FAULT	< 3 seconds	The cable and/or sensor connection is faulty
SPO2: SENSOR LIFE NEAR EXPIRATION	< 3 seconds	Sensor has less than 10% active monitoring life remaining

SPO2: ADHESIVE SENSOR LIFE EXPIRED	< 3 seconds	When a single-patient-use sensor is used, the adhesive portion of the sensor is non-functional, or the life of the adhesive portion of the sensor has expired.
SPO2: INCOMPATIBLE ADHESIVE SENSOR	< 3 seconds	Not a proper Masimo® single use sensor or single use Sensor is attached to a device without an appropriate parameter installed.
SPO2: UNRECOGNIZED ADHESIVE SENSOR	< 3 seconds	The currently connected single use sensor is not being recognized
SPO2: DEFECTIVE ADHESIVE SENSOR	< 3 seconds	The currently connected sensor is defective and unable to be used.
SPO2: ADHESIVE LIFE NEAR EXPIRATION	< 3 seconds	The adhesive is approaching its usable life and should be replaced when it is convenient.
SPO2: CHECK SENSOR	< 3 seconds	The technology board is unable to collect pulsing through the acoustic sensor
SPO2: ONLY MODE	< 3 seconds	Occurs during an unsuccessful sensor initialization/pulse search routine or during monitoring.
SPO2: DEFECTIVE SENSOR	< 3 seconds	The currently connected sensor is defective and unable to be used.

Table 39 - Medium Priority Alarms

Medium priority alarm	Delay	Description
SPO₂: FAILURE	< 3 seconds	Problem with the SpO ₂ sensor sent by Masimo.
SPO₂: SENSOR OFF PATIENT	< 3 seconds	Indicates that the sensor is not on the patient's finger.
SPO₂: NO SENSOR	< 3 seconds	Indicates that the sensor is not connected.
SPO₂: LOW PERFUSION	< 3 seconds	Indicates signal quality too low.
SPO₂: NO PULSE	< 3 seconds	Indicates that it is not detecting the beat signal.
SPO₂: INTERF. DETECTED	< 3 seconds	Indicates that light interference is disrupting the reading.
SPO₂: EXCEEDED OF LIGHT	< 3 seconds	Indicates that it is not possible to make the measurement due to excessive light.
SPO₂: NO ADHESIVE SENSOR	< 3 seconds	Indicates that the adhesive sensor is not connected.
SPO₂: LOW SIGNAL QUALITY	< 3 seconds	Indicates that signal quality is not good enough for monitoring.
SPO₂: NO CABLE	< 3 seconds	Cable not attached or not fully inserted into the connector.
SPO₂: SENSOR INITIALIZING	< 3 seconds	Device is checking the sensor for proper functioning and performance.

Table 40 - Low priority alarms

Low priority alarm	Delay	Description
SPO ₂ : BOARD FAILURE	< 3 seconds	Indicates that the SpO ₂ board has stopped working.
SPO ₂ : DISCONNECTED	< 3 seconds	Indicates that SpO ₂ has been disconnected during monitoring.

Table 41 - Messages

Message	Delay	Description
SPO ₂ : DETECTING PULSE	< 3 seconds	Indicates that SpO ₂ is initiating calculations.
SPO ₂ : CONNECTED	< 3 seconds	Indicates that the sensor is connected.
SPO ₂ : DEMO	< 3 seconds	Indicates that SpO ₂ is in demo mode.



WARNING

- *When receiving alarm information, promptly provide service to resolve the problem.*
- *Once the situation that requires the mute of the audible alarm is terminated, the alarms shall be reactivated for patient safety.*



ATTENTION

- *It may be dangerous if different alarm pre-configurations are used for the same or similar equipment in the same area, such as an intensive care unit or cardiac surgery room.*

10.18.6 Alarm Testing

To perform the alarm tests, a breathing circuit and a simulator balloon are necessary.



ATTENTION

- *Never perform the alarm test with the patient connected to the equipment.*

10.18.6.1 FiO₂ alarm

To test the high O₂ concentration alarm, set the alarm's upper limit concentration below the concentration adjusted in the mode parameters. To test the low O₂ concentration alarm, set the alarm's lower limit concentration above the concentration adjusted in the mode parameters.

10.18.6.2 Airway pressure alarm

To test the high pressure alarm, put the ventilator in PCV mode, set PEEP to zero, Control Pr to 5 and set the Ppeak alarm's upper limit to 5. Assemble the respiratory circuit, put the equipment to cycle and press the balloon so that the monitored pressure is greater than the set pressure. To test the low pressure alarm, set the Ppeak alarm's lower limit above inspiratory pressure monitored in the equipment.

10.18.6.3 Volume alarm

To test the high volume alarm, set the alarm's upper limit volume below the volume adjusted in the mode parameters. To test the low volume alarm, set the alarm's lower limit volume above the volume adjusted in the mode parameters.

10.18.6.4 No AC power alarm

Remove the power supply.

10.18.6.5 Low battery alarm

Leave the equipment on, unplugged and cycling for 3 hours.

10.18.6.6 Gas supply failure alarm

Disconnect the air and O₂ supply.

10.18.6.7 PEEP alarm

To test the high PEEP alarm, set the alarm's upper limit PEEP below the adjusted in the mode parameters. To test the low PEEP alarm, set the alarm's lower limit PEEP above the PEEP adjusted in the mode parameters.

10.18.6.8 Disconnection alarm

Disconnect the simulator from the respiratory circuit and leave the equipment cycling.

10.18.6.9 Obstruction alarm

The obstruction alarm is triggered when some form of obstruction occurs in the respiratory circuit that prevents complete expiration of the patient. In PEDIATRIC and ADULT mode, the criteria for triggering this alarm is based on the ratio of average values obtained from PEEP and the limiting pressure (P_{max}). When the pressure value is above the average of the reference parameters (PEEP and P_{max}), the alarm is triggered.

In NEONATAL mode, the obstruction alarm is activated when the airway pressure is above the SET PRESSURE + 5cmH₂O. When an occlusion occurs in the respiratory circuit, the ventilator drives an overpressure valve system that relieves pressure in the circuit in order to preserve the integrity of the patient's lungs.

To test the obstruction alarm operation, place the ventilator in normal operation and press the expiratory branches of the patient circuit to simulate the obstruction and observe the activation of the alarm.

10.18.6.10 Minute volume alarm

To test the high minute volume alarm, set the alarm's upper limit minute volume below the monitored in the equipment. To test the low minute volume alarm, set the alarm's lower limit minute volume above the minute volume monitored in the equipment.

10.18.6.11 Respiratory rate alarm

To test the high rate alarm, set the alarm's upper limit rate below the monitored in the equipment. To test the low rate alarm, set the alarm's lower limit rate above the rate monitored in the equipment.

10.18.6.12 Apnea alarm

To test the apnea alarm, set the apnea time to 3 seconds and adjust a low rate in the ventilatory mode. Put the ventilator in normal operation and wait the set time to occur the alarm.

10.18.6.13 EtCO₂ alarm

To test the EtCO₂ alarm, connect a capnograph to the ventilator. Assemble the respiratory circuit to use with the capnograph and blow the airway adapter so that the ventilator monitors the capnograph parameters. To test the high EtCO₂ alarm, set the alarm's upper limit EtCO₂ below the monitored in the equipment. To test the low EtCO₂ alarm, set the alarm's lower limit EtCO₂ above the EtCO₂ monitored in the equipment.



WARNING

- *Airway adapters are single use. The re-use may result in cross contamination.*

10.18.6.14 iCO₂ alarm

To test the iCO₂ alarm, connect a capnograph to the ventilator. Assemble the respiratory circuit to use with the capnograph and blow the airway adapter so that the ventilator monitors the capnograph parameters. To test the high iCO₂ alarm, set the alarm's limit iCO₂ below the monitored in the equipment.



WARNING

- *Airway adapters are single use. The re-use may result in cross contamination.*
-

10.18.6.15 Heart rate alarm

To test the heart rate alarm, connect an oximeter to the ventilator. Assemble the respiratory circuit and connect the oximeter in the finger to monitor the oximeter parameters. To test the high heart rate alarm, set the alarm's upper limit heart rate below the monitored in the equipment. To test the low heart rate alarm, set the alarm's lower limit heart rate above the heart rate monitored in the equipment.

10.18.6.16 SpO₂ alarm

To test the SpO₂ alarm, connect an oximeter to the ventilator. Assemble the respiratory circuit and connect the oximeter in the finger to monitor the oximeter parameters. To test the SpO₂ alarm, set the alarm's limit SpO₂ below the monitored in the equipment.

10.18.7 Battery test

To check the battery status, enter the Battery menu, where the voltage and battery status information will be displayed. To test the operation of the battery, disconnect the equipment from the electrical power and check that the remaining battery power is displayed in percentage. Wait a few minutes, reconnect the machine to the electrical power and check that the battery is recharged.

10.19 Performance Specifications

Table 42 - Performance specifications

Parameter	Specification	Unit	Tolerance	
Valve Response Time T _{0.90}	10	ms	± 20%	
	Adult	180	L/min	± 10%

Parameter	Specification		Unit	Tolerance
Maximum Flow in Supporting Pressure and Spontaneous Breathing	Neonatal	60	L/min	± 10%
Maximum Leak Compensated Flow – Invasive Modalities ¹	Neonatal	20	L/min	± 10%
	Pediatric	35	L/min	± 10%
	Adult	120	L/min	± 10%
Maximum Leak Compensated Flow – Non-Invasive Modalities ²	Neonatal	30	L/min	± 10%
	Pediatric	35	L/min	± 10%
	Adult	120	L/min	± 10%

Observation

- Pressure-controlled ventilation is recommended for leakage flows greater than the limit specified above.
- In this case the maximum compensated flow may be greater than 100 L / min.

10.20 Respiratory Circuit Specifications

Table 43 - Expiratory and inspiratory branch resistance specifications

Respiratory circuit	Flow (L/min)	Resistance (hPa or cmH ₂ O) ¹			
		Circuit	Circuit + Flow Sensor	Circuit + Flow Sensor + HME Filter	Circuit + Flow Sensor + CO ₂ Sensor + HME Filter
Neonatal	2.5	0.3	0.85 ⁽¹⁾		
Pediatric	15.0	0.2	1.7	1.8	1.9 ⁽¹⁾
Adult	30.0	0.4	0.7	1.55	1.75 ⁽¹⁾

¹ Maximum resistance to assure the accuracy.

Table 44 - Respiratory circuit compliance specification

Respiratory circuit	Pressure (cmH ₂ O)	Compliance default ⁽¹⁾ (mL/cmH ₂ O)	Maximum Compliance ⁽²⁾ (mL/cmH ₂ O)
Neonatal	60 ± 3	0,5	1.5

¹ In pressure-controlled modes

² In all modalities

Pediatric	60 ± 3	1	4
Adult	60 ± 3	2	5

1 Default compliance will be used if the auto test is not performed or if a failure occurs.
2 Maximum compliance to assure the accuracy

Table 45 - Operation Specifications

Description	Specification	Tolerance
Recommended Maximum Operating Temperature	37 °C	± 3 °C
Recommended maximum operating pressure	120 cmH2O	± 2 cmH2O

10.21 Maintenance and Calibration Specifications

Table 46 - Maintenance and calibration specifications

Description	Specification	Tolerance
Inspection and replacement of integrated valve diaphragm	Under inspection or 5,000 hours or 12 months (whichever comes first)	± 500 h / ± 1 month
Inspection and replacement of the O ₂ galvanic cell	Recommended replacement if there are problems with calibration or 10,000 hours or 24 months (whichever comes first)	
inspection and Replacement of Internal Battery	10,000 hours or 24 months (whichever comes first)	
Equipment Inspection	5,000 hours or 12 months (whichever comes first)	
Calibration of equipment	5,000 hours or 12 months (whichever comes first)	
FlowAir System	30,000 hours or 72 months (whichever comes first)	
Lifetime (useful life)	10 years	---

10.22 IRMA CO₂ Sensor Specifications

Table 47 - IRMA CO₂ sensor - General specifications

General specifications	
Description	Mainstream monitoring sensor with infrared technology.
Dimensions (L x P X A)	38 x 37 x 34mm (1.49" x 1.45" x 1.34")
Cable length	2.50m (± 0.02m)
Weight	<25g (without cable) <38g (with cable)
Atmospheric Operating Pressure	525 to 1200 hPa (525 hPa corresponds to an altitude of 4572m or 15,000 feet).
Storage and Transport Atmospheric Pressure	500 to 1200 hPa.

General specifications	
Mechanical resistance	Supports 1m repeated drops on a hard surface.
Power Supply	4.5-5.5 VDC ≤ 1.0 W (normal operation @ 5V) < 1.8W (power surge @5V can last up to 400 ms when entering measurement mode from sleep mode or during start-up)
Surface Temperature (Ambient Temperature of 23 ° C)	Maximum 39°C (102°F)
Airway Adapter	<u>Adult / Pediatric (Disposable):</u> Adds less than 6ml of dead space; Loss of pressure less than 0.3cmH20 at 30L / min. <u>Infant (Single use):</u> Adds less than 1ml of dead space; Loss of pressure less than 1.3cmH20 at 10L / min.

Table 48 - IRMA CO₂ Sensor - Outputs

Outputs	
Breath Detection	Adaptive threshold, minimum 1 vol% change in CO ₂ concentration.
Respiratory rate	0–150 ±1 bpm. The respiration rate is displayed after three breaths and the average value is updated every breath.
Fi and ET	Fi and ET are displayed after one breath and have a continually updated breath average.
Wave forms	CO ₂ .
Diagnostic Parameters	Atmospheric pressure, software and hardware revision, serial number.
Information	New Breath Detection, Apnea, Check Adapter, Unspecified Accuracy, and Sensor Error.
Method used to calculate end-tidal (ET) values	The highest concentration of CO ₂ during one breathing cycle with a weight function applied to favor values closer to the end of the cycle.

Table 49 - IRMA CO₂ sensor - Gas analyzer

CO₂ Gas Analyzer	
Sensor	2 channel NDIR type gas analyzer measuring at 4–5.5 μm. Data acquisition rate 10 kHz (sample rate 20Hz). Pressure, temperature and full spectral interference correction.
Calibration	No span calibration required for the IR bench.
Warm-up Time	< 10 seconds (concentrations reported and full accuracy)
Rise time (at 10 L/min)	CO ₂ ≤ 90ms.

CO₂ Gas Analyzer

Analyzer system response time	< 1s.
-------------------------------	-------

Observations

- Accurate CO₂ monitoring is achieved 1 minute after initialization.
- Measured according to EN ISO 80601-2-55.

Table 50 - IRMA CO₂ sensor – Accuracy I

Exactitude / accuracy of measurements (under standard conditions)		
Type of Gas	Range (AX+)	Accuracy
CO ₂	0 to 15	±(0,2 vol% + 2% of reading)
	15 to 25	Not specified
<i>Note: Concentration of gases expressed in units of percentage volume.</i>		

Table 51 - IRMA CO₂ sensor - Accuracy II

Exactitude / accuracy of measurements (under all conditions)	
Type of Gas	Accuracy
CO ₂	± (0.3 vol% + 4% of reading)
<i>Note: The accuracy specification is valid for any specified environmental condition, except as described in the table below with "Effects of Gas and Vapor Interference".</i>	

Table 52 - IRMA CO₂ sensor - Effects of gas and vapor interference

Effects of gas and vapor interference		
Gases or Vapor	Gas Level	CO ₂
N ₂ O ⁽⁴⁾	60 vol%	--- (1 and 2)
HAL ⁽⁴⁾	4 vol%	--- (1)
ENF, ISO, SEV ⁽⁴⁾	5 vol%	+8% of the read measurement. ⁽³⁾
DES ⁽⁴⁾	15 vol%	+12% of the read measurement. ⁽³⁾
Xe (Xenon) ⁽⁴⁾	80 vol%	-10% of the read measurement. ⁽³⁾
He (Helium) ⁽⁴⁾	50 vol%	-6% of the read measurement. ⁽³⁾
Measured dose inhaler propellant ⁽⁴⁾	Not designed for use with a measured-dose propellant inhaler.	
C ₂ H ₅ OH (Ethanol) ⁽⁴⁾	0,3 vol%	--- (1)

Effects of gas and vapor interference		
C ₃ H ₇ OH (Isopropanol) ⁽⁴⁾	0,5 vol%	--- (1)
CH ₃ COCH ₃ (Acetone) ⁽⁴⁾	1 vol%	--- (1)
CH ₄ (Methane) ⁽⁴⁾	3 vol%	--- (1)
CO (Carbon Monoxide) ⁽⁵⁾	1 vol%	--- (1)
NO (Nitrogen Monoxide) ⁽⁵⁾	0,02 vol%	--- (1)
O ₂ ⁽⁵⁾	100 vol%	--- (1 and 2)

- (1) Negligible interference, effect included in the specification "Accuracy, all conditions" above.
- (2) For sensors that are not measuring N₂O and / or O₂, concentrations must be entered manually by the user.
- (3) Interference at indicated gas level. For example, 50 vol% Helium typically decreases the CO₂ readings by 6%. This means that if measuring on a mixture containing 5.0 vol% CO₂ and 50 vol% Helium, the actual measured CO₂ concentration will typically be $(1-0.06) * 5.0 \text{ vol\%} = 4.7 \text{ vol\% CO}_2$.
- (4) According to the EN ISO 80601-2-55 standard.
- (5) In addition to the EN ISO 80601-2-55 standard.

Table 53 – Effects from Water Vapor Partial Pressure on Gas Readings

Temp [C]	RH [%]	P [hPa]	H ₂ O part.pres [hPa]	Err _{rel} [%]	Err _{rel} ATPD [%]	Err _{rel} [%] BTPS
10	20	1013	2	0	-0,2	+6,0
20	20	1013	5	0	-0,5	+5,7
25	0	1013	0 (ATPD)	0	0	+6,2
25	23	1013	7,3	0	-0,7	+5,5
25	50	1013	16	0	-1,6	+4,6
30	80	1013	42	0	-4,1	+2,0
37	100	1013	63 (BTPS)	0	-6,2	0
37	100	700	63	0	-9,0	-2,8

10.23 Oximeter specifications

Table 54 – Performance specifications

Specification Criteria	Functional SpO ₂ (%)	Pulse Rate (bpm)	Perfusion index (%)	PVI (%)
Display Range	0.0 - 100.0 %	25 – 240 bpm	0.02 – 20.0 %	0 – 100 %
Calibration Range	70 – 100 %	25 – 240 bpm	0.10 – 20.0 %	-
Calibration Standard	Invasive Co-oximeter	ECG and Patient Simulator	Patient Simulator	-
No motion accuracy (ms)	≤ 2.0 %	≤ 3.0 bpm	-	-
Motion Accuracy (rms)	≤ 3.0 %	≤ 5.0 bpm	-	-
Resolution	≤ 0.1 %	≤ 1 bpm	≤ 0.01 %	≤ 1 %
Time to Display	≤ 8, ≤ 12 s	≤ 8, ≤ 12 s	≤ 8, ≤ 12 s	-
Asystole Detection Time	≤ 8 s	≤ 8 s	≤ 8 s	-
Delay	≤ 10 s	≤ 10 s	≤ 10 s	-
Response Time	≤ 20 s	≤ 20 s	≤ 20 s	-

Display Update Frequency	≥ 1 Hz	≥ 1 Hz	≥ 1 Hz	≥ 1 Hz
Averaging Time (s)	2-4, 4-6, 8, 10, 12, 14, 16	-	-	-
Maximum Power Output	15 mW	-	-	-

For each specified range, the SpO2 ACCURACY of the PULSE OXIMETRY EQUIPMENT is determined in terms of the difference in mean square value (vqm) between the measured values (SpO2i) and the reference value (SRi), as given by the Equation:

$$A_{rms} = \sqrt{\frac{\sum_{i=1}^n (SpO_{2i} - S_{Ri})^2}{n}}$$

The pulse rate ACCURACY is defined over the full declared range, as the difference in mean square value (vqm) between paired pulse rate data, recorded with the PULSE OXIMETRY EQUIPMENT and with a reference method. The reference method used was a Biotek Index 2™ electronic pulse simulator.

Table 55 – Environmental specifications

Characteristic	Specification
Operating Conditions	
Incandescent light intensity	100 k Lux (Sunlight)
Fluorescent Light Intensity	10 k Lux
Fluorescent Light Frequency	50, 60 Hz ± 1.0 Hz
Temperature	5 to 40 °C
Humidity	15 to 95 %, non-condensing
Pressure	500 to 1060 mbar
Storage Conditions	
Temperature	-40 to 70 °C
Humidity	15 to 95 %, non-condensing

10.24 Electromagnetic Compatibility

Changes or modifications to this equipment not expressly approved by MAGNAMED may cause EMC problems with this equipment. Contact MAGNAMED for technical assistance.

This equipment has been designed and tested to comply with the applicable EMC standards as described below:

- Immunity: IEC 60601-1-2
- Emission: CISPR11 (Group 1 – Class A)
- Approvals: OS / IEC 60601-1

This equipment has been designed and tested to meet the following essential requirements: deliver volume within alarm limits or generate alarm condition; FiO₂ monitoring; generate PEEP alarm conditions when PEEP is above or below the alarm limit; monitor expired volume; alarm condition to indicate when the electrical voltage has fallen below what is necessary to maintain normal operation; alarm condition to indicate when the battery charge is near the end; technical alarm condition to indicate failure of the air and oxygen network; limiting the reverse flow between the gas port to values below 100 mL/h; ensure the accuracy of the oxygen level within the specified range.



WARNING

- *Use of mobile phones or other radio-frequency (RF) emitting equipment near the system may cause unexpected or adverse results. Monitor operation if there are sources of radiofrequency emission in the vicinity.*
- *Use of other electrical equipment in or near the system may cause interference. Before use on the patient, you should check that the equipment functions normally in the set configuration.*
- *The use of this adjacent equipment or other equipment shall be avoided as it may result in improper operation. If this is necessary, this and other equipment shall be observed to verify that they are operating normally.*
- *The use of accessories, transducers, and cables other than those specified or provided by Magnamed may result in high electromagnetic emissions or reduced electromagnetic immunity from this equipment and result in improper operation.*
- *Portable RF communication equipment (including peripherals such as antenna cables and external antennas) shall not be used within 30 cm of any part of the Fleximag Max, including cables specified by Magnamed. Failure to do so may cause performance degradation.*
- *If essential performance is affected or degraded due to electromagnetic disturbances, the ventilator may stop ventilating. In this case, the operator shall provide manual ventilation.*

10.24.1 Guidelines and manufacturer's declaration - Electromagnetic emissions

The Fleximag Max is intended for use in the electromagnetic environment specified below. It is recommended that the customer or user of Fleximag Max ensure that it is used in such an environment.

Emissions Testing	Compliance	Electromagnetic environment - guidelines
RF emissions CISPR 11	Group 1	Fleximag Max uses RF energy only for its internal functions. Therefore, RF emissions are very low and are not likely to cause any interference in nearby electronic equipment.
RF emissions CISPR 11	Class A	The Fleximag Max is suitable for use in all establishments other than domestic and those directly connected to the public low-voltage power supply network that supplies buildings for domestic purposes, as long as the following warning is respected:
Harmonic emissions IEC 61000-3-2	Class A	Warning: This equipment / system is intended for use by healthcare professionals only. This equipment / system may cause radio interference or may impair the operation of nearby equipment. It may be necessary to take measures such as reorienting or relocating the Fleximag Max or shielding the site.
EF voltage fluctuations / flicker emissions IEC 61000-3-3	Complies	

10.24.2 Guidelines and manufacturer's declaration - Electromagnetic immunity

The Fleximag Max is intended for use in the electromagnetic environment specified below. It is recommended that the purchaser or user of Fleximag Max ensure that it is used in such an environment.

Immunity Test	IEC-60601 Test Level	Level of Compliance	Electromagnetic environment - guidelines
IEC 61000-4-2 - Electrostatic discharge (ESD)	± 8 kV per contact ± 15 kV through the air	± 8 kV per contact ± 15 kV through the air	Floors should be made of wood, concrete or ceramic. If the floors are covered with synthetic material, the relative humidity should be at least 30%.
IEC 61000-4-4 - Electrical Fast Transit / Pulse Train ("Burst")	± 2 kV at the input power input c.a.	± 2 kV at the input power input c.a.	Mains power quality should be that of a typical commercial or hospital environment.
IEC 61000-4-5 - Surge	± 1 kV line (s) to line (s) ± 2 kV line (s) to ground	± 1 kV line (s) to line (s) ± 2 kV line (s) to ground	Mains power quality should be that of a typical commercial or hospital environment.
IEC 61000-4-11 - Voltage dips	0% UT; 0.5 cycle at 0 °, 45 °, 90 °, 135 °, 180 °, 225 °, 270 ° and 315 ° 0% UT; 1 cycle (single phase: at 0 °) 70% UT; 25/30 cycles (single phase: at 0 °) <5% UT (> 95% UT voltage drop) for 5 seconds.	0% UT; 0.5 cycle at 0 °, 45 °, 90 °, 135 °, 180 °, 225 °, 270 ° and 315 ° 0% UT; 1 cycle (single phase: at 0 °) 70% UT; 25/30 cycles (single phase: at 0 °) <5% UT (> 95% UT voltage drop) for 5 seconds.	Quality of energy supply should be that of a typical hospital or commercial environment.
IEC 61000-4-11 - Voltage interruptions	0% UT; 250/300 cycles	0% UT; 250/300 cycles	Quality of energy supply should be that of a typical hospital or commercial environment.
IEC 61000-4-8 - Magnetic field of the frequency of mains (50/60 Hz)	30 A/m	30 A/m	Magnetic fields in the frequency of feeding should be at levels characteristic of a typical location in a typical hospital or commercial setting

Note: UT is the a.c. mains voltage prior to application of the test level.

The **Fleximag Max** is intended for use in the electromagnetic environment specified below. It is recommended that the purchaser or user of **Fleximag Max** ensure that it is used in such an environment.

Immunity Test	IEC-60601 Test Level	Level of Compliance	Electromagnetic environment - guidelines
Conducted RF IEC 61000-4-6	3 Vrms 150 kHz to 80 MHz outside the ISM bands (a)	3 V	Portable and mobile RF communications equipment should be used no closer to any part of Fleximag Max, including cables, than the recommended separation distance calculated from the equation applicable to the frequency of the transmitter. Recommended separation distance: $d = 1.2\sqrt{P}$
	6 Vrms 150 kHz to 80 MHz in the ISM bands (a)	6 V	
Radiated RF IEC 61000-4-3	3 V/m 80 MHz to 2.7 GHz	3 V/m	$d = 1.2\sqrt{P}$ 80 MHz to 800 MHz
			$d = 2.3\sqrt{P}$ 800 MHz to 2.5 GHz

where P is the maximum output power rating of the transmitter in watts (W) according to the transmitter manufacturer and d is the recommended separation distance in meters (m).^b
Field strengths from fixed RF transmitters, as determined by an electromagnetic site survey^c, should be less than the compliance level in each frequency range^d
Interference may occur in the vicinity of equipment marked with the symbol:



NOTE 1 At 80 MHz and 800 MHz, the higher frequency range applies.

NOTE 2 These guidelines may not apply in all situations. Electromagnetic propagation is affected by absorption and reflection from structures, objects and people..

^a The ISM (industrial, scientific and medical) bands between 150 kHz and 80 MHz are 6,765 MHz to 6,795 MHz; 13,553 MHz to 13,567 MHz; 26,957 MHz to 27,283 MHz; and 40,66 MHz to 40,70 MHz.

^b The compliance levels in the ISM frequency bands between 150 kHz and 80 MHz and in the frequency range 80 MHz to 2,5 GHz are intended to decrease the likelihood that mobile/portable communications equipment could cause interference if it is inadvertently brought into patient areas. For this reason, an additional factor of 10/3 has been incorporated into the formulae used in calculating the recommended separation distance for transmitters in these frequency ranges.

^c Field strengths from fixed transmitters, such as base stations for radio (cellular/cordless) telephones and land mobile radios, amateur radio, AM and FM radio broadcast and TV broadcast cannot be predicted theoretically with accuracy. To assess the electromagnetic environment due to fixed RF transmitters, an electromagnetic site survey should be considered. If the measured field strength in the location in which the Fleximag Max is used exceeds the applicable RF compliance level above, the Fleximag Max should be observed to verify normal operation. If abnormal performance is observed, additional measures may be necessary, such as re-orienting or relocating the Fleximag Max.

^d Over the frequency range 150 kHz to 80 MHz, field strengths should be less than 3 V / m.

Recommended separation distances between portable and mobile RF communications equipment and the Fleximag Max

The **Fleximag Max** is intended for use in an electromagnetic environment in which radiated RF disturbances are controlled. The customer or the user of the **Fleximag Max** can help prevent electromagnetic interference by maintaining a minimum distance between portable and mobile RF communications equipment (transmitters) and the **Fleximag Max** as recommended below, according to the maximum output power of the communications equipment.

Separation distance according to frequency of transmitter (m)

Rated maximum output power of transmitter (W)	150 kHz to 80 MHz outside ISM bands	150 kHz to 80 MHz in ISM bands	80 MHz to 800 MHz	800 MHz to 2.5 GHz
	$d = 1.2\sqrt{P}$	$d = 1.2\sqrt{P}$	$d = 1.2\sqrt{P}$	$d = 2.3\sqrt{P}$
0.01	0.12	0.12	0.12	0.23
0.1	0.38	0.38	0.38	0.73
1	1.2	1.2	1.2	2.3
10	3.8	3.8	3.8	7.3
100	12	12	12	23

For transmitters rated at a maximum output power not listed above, the recommended separation distance d in meters (m) can be determined using the equation applicable to the frequency of the transmitter, where P is the maximum output power rating of the transmitter in watts (W) according to the transmitter manufacturer.

NOTE 1 At 80 MHz and 800 MHz, the separation distance for the higher frequency range applies.

NOTE 2 The ISM (industrial, scientific and medical) bands between 150 kHz and 80 MHz are 6,765 MHz to 6,795 MHz; 13,553 MHz to 13,567 MHz; 26,957 MHz to 27,283 MHz; and 40,66 MHz to 40,70 MHz.

NOTE 3 An additional factor of 10/3 has been incorporated into the formulae used in calculating the recommended separation distance for transmitters in the ISM frequency bands between 150 kHz and 80 MHz and in the frequency range 80 MHz to 2,5 GHz to decrease the likelihood that mobile/portable communications equipment could cause interference if it is inadvertently brought into patient areas.

NOTE 4 These guidelines may not apply in all situations. Electromagnetic propagation is affected by absorption and reflection from structures, objects and people.

Fields in the vicinity of RF wireless communication equipment

The Fleximag Max enclosure interface was tested as specified in the table below using the test methods specified in IEC 61000-4-3

Band [MHz]	Freq. test [MHz]	Modulation	Test level [V/m]
380 to 390	385	Pulse, 18 Hz	27
430 to 470	450	FM, 1 kHz, Deviation from \pm 5kHz	28
704 to 787	710 745 780	Pulse, 217 Hz	9
800 to 960	810 870 930	Pulse, 18 Hz	28
1.700 to 1.990	1.720 1.845 1.970	Pulse, 217 Hz	28
2.400 to 2.570	2.450	Pulse, 217 Hz	28
5.100 to 5.800	5.240 5.500 5.785	Pulse, 217 Hz	9

Radiated fields in close proximity

The Fleximag Max enclosure interface was tested as specified in the table below using the test methods specified in IEC 61000-4-39

Test Frequency	Modulation	Test level [A/m]
30 kHz	CW	8
134,2 kHz	Pulse, 2,1 kHz	65
13,56 MHz	Pulse, 50 kHz	7,5

Observation

- ***The EMISSION characteristics of this equipment make it suitable for use in industrial areas and hospitals (ABNT NBR IEC / CISPR 11 class A). If used in a residential environment (for which ABNT NBR IEC / CISPR 11 class B is normally required), this equipment may not provide adequate protection for radio frequency communication services. The user may need to take mitigation measures, such as relocating or reorienting the equipment.***

10.24.3 Electrical safety

The following are the precautions that shall be observed when combining these items (non-medical equipment) with the system.



WARNING

- *Items that do not comply the requirements of IEC 60601-1 cannot be placed within 1.5 m of the patient.*
- *Do not connect non-medical electrical equipment directly to the wall outlet. Use AC power supply with own transformer. Otherwise, current leakage will increase above the levels accepted by IEC 60601-1 under normal conditions and single fault conditions. This may cause dangerous electrical shock to the patient or the operator.*
- *After connecting any equipment to these outlets, subject the system to a complete leakage current test (in accordance with IEC 60601-1).*
- *The electromedical system operator shall not touch non-medical electrical equipment and the patient simultaneously. This may cause dangerous electrical shock to the patient or the operator.*
- *Do not connect a multiple socket or extension cable to the electromedical system.*

10.25 Audible acoustic energy

Table 56 – Audible acoustic energy specification

Configuration	Sound Pressure Level	Sound Power Level
Volume \geq 300 mL	47 dB \pm 2 dB	55 dB \pm 2 dB
300 mL \geq Volume \geq 50 mL	46 dB \pm 2 dB	54 dB \pm 2 dB
Volume \leq 50 mL	45 dB \pm 2 dB	53 dB \pm 2 dB

10.26 Mask to non-invasive ventilation

Table 57 – Mask to NIV ventilation specification

Specification	
Adult/ pediatric connection	22 mm
Neonatal connection	15 mm



WARNING

- Use only MASKS specified by MAGNAMED with local registration and CE mark.
- Use MASK suitable for patient type to avoid excessive leakage.

10.27 Respiratory Circuit

Table 58 – Respiratory circuit specification

Specification	
Adult connection	22 mm
Pediatric / Neonatal connection	15 mm
Resistance	≤ 0.3 mbar/L.s-1



WARNING

- Use only respiratory circuit specified by MAGNAMED with local registration and CE mark.
- Use respiratory circuit suitable for patient type to avoid excessive leakage.

10.28 HME Filter



ATTENTION

- It is recommended the use of HME filter following the specifications given below with local registration and CE mark.

Table 59 – HME filter specification

Specification	
Compliance	ISO 23328-1, ISO 23328-2, ISO 9360-1 and ISO 9360-2

Connection	22 mm (female)	
Connection to breathing tubes	22 mm (male) / 15 mm (female)	
Bacterial and viral filtration efficiency	99,99%	
Resistance	30 L/min	2,02 cmH ₂ O
	60 L/min	5,19 cmH ₂ O
	90 L/min	9,37 cmH ₂ O

10.29 HEPA Filter

ATTENTION

- *In order to avoid cross contamination, a HEPA filter following the specifications given below.*

Table 60 – HEPA filter specification

Specification		
Compliance	ISO 23328-1 and ISO 23328-2	
Connection to conical connectors	22 mm (female)	
Connection to breathing tubes	22 mm (male) / 15 mm (female)	
Bacterial and viral filtration efficiency	99,99%	
Resistance	30 L/min	1 cmH ₂ O

10.30 Internal volume of the breathing circuit components

Table 61 - Internal volume of the breathing circuit components

internal volume	
Trachea 22mm x 1.20 m autoclavable 22f+22f	407,8 mL
Y adult 22mm autoclavable with straight thermometer	18,7 mL

internal volume	
Trachea 15mm x 1.20 m autoclavable 15f+22f	179,5 mL
Intermediate 15m+15m for autoclavable infant breathing circuit	3,6 mL
Pediatric's Y 15mm autoclavable without thermometer 90	16,9 mL
Airway adapter	9,0 mL
Autoclavable adult flow sensor	8,4 mL
Autoclavable infant flow sensor	8,0 mL
Autoclavable neonatal flow sensor	7,7 mL

11 IRMA CO₂ Sensor (optional)

11.1 Intended Use

The measurement of CO₂ in the breathing gas mixture is based on the fact that different gas components absorb infrared light at specific wavelengths. A beam of invisible infrared light is directed through the respiratory gas flow in the IRMA Airway Adapter. As the beam passes through the IRMA Airway Adapter, some of the light is absorbed by the gas mixture. The amount of absorbed light is measured by a miniaturized two channel spectrometer positioned to receive the infrared light beam.

The spectrometer incorporates a filter wheel fitted with optical "color" filters. The wavelength ranges of these filters are chosen such that one filters out colors where carbon dioxide has very strong absorption and the other filters out colors where carbon dioxide has no absorption.

The spectrometer also incorporates an infrared detector that converts the light beam to an electrical signal. The electrical signal is converted to a digital value that is fed to a microprocessor. The ratio of the light measured through the different filters is then used by the microprocessor to calculate the carbon dioxide concentration in the breathing gas mixture.

11.2 Instructions for use

The IRMA CO₂ sensor is designed to be used connected to Magnamed ventilators and any other compatible monitoring device. Its function is to monitor the signal and the concentration value of the gas in real time.

It shall not be used as the sole means of monitoring the patient. It shall always be used in conjunction with other vital signs monitoring equipment and this process should be accompanied by a specialist capable of analyzing the patient's conditions.

The IRMA CO₂ sensor is designed for use by trained and authorized healthcare professionals only.



WARNING

- *The sensor shall not have direct contact with the patient during its use.*
- *Perform the leak test in the patient circuit with the airway adapter connected to the circuit.*
- *Always check the gas reading and waveform in the ventilator before to connect the airway adapter in the patient circuit.*
- *Ventilation with cyclic pressure up to 100 cmH₂O does not interfere with gas reading.*
- *It shall not be used as the sole means of monitoring the patient. It shall always be used in conjunction with other vital signs monitoring equipment and this process should be accompanied by a specialist capable of analyzing the patient's conditions.*
- *The IRMA CO₂ sensor is designed for use by trained and authorized healthcare professionals only.*
- *The IRMA CO₂ sensor shall be operated exclusively by trained and authorized medical personnel.*
- *The IRMA CO₂ sensor is designed to be an adjunct device in patient monitoring, so its information should be analyzed along with other measurements and symptoms.*

11.2.1 Reset procedure

To ensure high accuracy in the values measured by the IRMA sensor, the following zeroing recommendations shall be followed.



WARNING

- *Incorrect sensor reset will result in incorrect reading of measured values.*



Observations

- *The sensor zeroing option is available in the CALIBRATION window as soon as the sensor is identified and ready for use.*
- *It may take a few seconds until the sensor is ready for the zeroing process.*

Zeroing shall be done by connecting an airway adapter to the sensor without connecting it to the respiratory circuit. When the gas monitoring signals are stable, press the button to start the zero reset.

Exceptional care should be taken to avoid breathing near the sensor before or during the reset. The presence of ambient air (21% O₂ and 0% CO₂) in the airway adapter is of crucial importance for successful zeroing. If the calibration error message appears immediately after the end of the zeroing procedure, it shall be repeated.

Zeroing shall be performed every time the airway adapter is replaced. It shall also be executed whenever there is a displacement of the baseline (offset) in any of the gas measurements or when any of the alarm messages are displayed: "CO₂: PARAM OUT OF RANGE ", "CO₂: OUT OF RANGE" or "CO₂: ZERO REQUIRED".

After connecting the sensor or replacing the airway adapter, wait at least one minute before starting the zeroing procedure to allow the sensor to warm up.

The green LED on the sensor will blink for 5 seconds while the reset process is in progress.

11.2.2 LED status information

Table 62 - IRMA CO₂ Status LEDs

Color (state)	Significance
Green (constantly on)	System OK
Green (blinking)	Zeroing in progress
Blue (constantly on)	Anesthetic agent present
Red (constantly on)	Sensor error
Red (blinking)	Check the adapter

11.3 Preventive maintenance

Once every year it is recommended to perform a gas span check on IRMA with a reference instrument or with calibration gas. A Gas Regulator Kit (P/N 900910) can be ordered from Masimo.

11.4 Important Notices



WARNING

- *The IRMA CO₂ sensor shall be operated exclusively by trained and authorized medical personnel.*
- *The sensor shall not be used with flammable anesthetic agents.*
- *Airway adapters shall not be reused. Reusing a disposable adapter may cause cross-infection.*
- *Do not use the adult / pediatric airway adapter in neonates as the adapter adds a 6mL dead space to the patient's breathing circuit.*
- *Do not use the neonate airway adapter in adult patients as this adapter may add*

excessive resistance.

- *Measurements may be affected by radio-frequency communication equipment or cellular devices.*
- *The user must make sure that the sensor is used in environments that comply with the electromagnetic environment specifications stated in this manual.*
- *Do not use the airway adapter with measured-dose inhalers or nebulized medications as they may affect the transmission of light into the sensor windows.*
- *The IRMA CO₂ sensor is designed to be an adjunct device in patient monitoring, so its information should be analyzed along with other measurements and symptoms.*
- *Incorrect zeroing may result in erroneous measurements.*
- *Replace the airway adapter if there is condensation inside the adapter.*
- *Use only airway adapters and sensors produced by Masimo.*
- *The sensor shall not come in direct contact with the patient during use.*
- *Do not connect the airway adapter between the endotracheal tube and the respiratory circuit elbow as this can cause patient secretions to block the adapter windows, causing incorrect sensor operation.*



Figure 2 - Incorrect and correct positioning of the airway adapter

- *IRMA should only be used for the purpose and in the manner described in this manual.*
- *Do not adjust, repair, open, disassemble, or modify the IRMA. Damage to the device may result in degraded performance and/or patient injury.*
- *The IRMA is not intended to be in patient contact.*
- *If for whatever the reason the IRMA device is in direct contact with any parts of the infant's body an insulation material shall be placed between the IRMA and the body.*
- *The IRMA is not designed for MRI environments.*
- *IRMA Airway Adapters shall not be reused. Reuse of single use Adapters can cause cross infection.*
- *Do not use the IRMA Infant Airway Adapter with adults/pediatrics as this may cause excessive flow resistance.*
- *Disconnect the device from power by removing the device cable connection from the medical backboard device.*
- *Use and store the IRMA in accordance with specifications. See the Specifications section in this manual.*

-
- *IRMA should not be used as the sole basis for medical decisions. It must be used in conjunction with clinical signs and symptoms.*
 - *Use only IRMA Airway Adapters manufactured by Masimo.*
 - *No modification of the IRMA probe or the IRMA Airway Adapters is allowed.*
 - *Light transmission can be affected by secretions and moisture pooling on the IRMA Airway Adapter XTP™ windows. When using heated humidifiers special care should be paid to position the Airway Adapter in a vertical position and to change Airway Adapter if necessary.*
 - *Do not place the IRMA Airway Adapter between the endotracheal tube and an elbow as this may allow patient secretions to block the adapter windows and result in incorrect operation.*
 - *Use of this equipment adjacent to or stacked with other equipment should be avoided because it could result in improper operation. If such use is necessary, this equipment and the other equipment should be observed to verify that they are operating properly.*
 - *Make sure that IRMA is used in the electromagnetic environment specified in this manual.*
 - *Use of high-frequency electrosurgical equipment in the vicinity of IRMA may produce interference and cause incorrect measurements.*
 - *Portable RF communications equipment (including peripherals such as antenna cables and external antennas) should be used no closer than 30 cm (12 inches) to any part of the IRMA including cable. Otherwise, degradation of the performance of the IRMA could result.*
 - *Incorrect zeroing of IRMA will result in false gas readings.*
 - *To avoid electric shock, always physically disconnect the IRMA and all patient connections before cleaning.*
 - *Any changes or modifications not expressly approved by Masimo shall void the warranty for this equipment and could void the user's authority to operate the equipment.*
-



ATTENTION

- *Do not apply electrical voltage to the sensor cable.*
 - *Do not use the sensor in environments with specifications outside the limits stated in your technical specification.*
-

12 Pulse Oximeter (optional)

12.1 Intended Use

The Masimo MS-2040 pulse oximeter is a self-contained solution that allows the safe measurement of SpO₂, pulse rate, perfusion index and PVI, even with movement or low perfusion.

12.2 Principle of Operation

The MS board of the Masimo SET pulse oximeter is based on three principles:

1. Differential absorption of oxyhemoglobin and deoxyhemoglobin from red and infrared lights (spectrophotometry).
2. The volume of arterial blood in the tissue and the light absorbed in the blood changes (plethysmography).
3. Arteriovenous shunting is highly variable and its fluctuation of absorbance through the venous blood is a major component of noise during the pulse.

The MS board of the Masimo SET pulse oximeter as well as the traditional pulse dosimetry determines SpO₂ by the passage of red and infrared light in a capillary bed and changes the measurement during the pulsatile cycle. Red and infrared (LED) emitting diodes on the oximetry sensors serve as light source, the photodiode serves as a photodetector.

Traditionally pulse oximetry assumes that all pulsations in the light absorption signal are caused by oscillations in arterial blood volume. Assuming that the blood flow in the sensor region passes entirely through the capillary bed rather than some arteriovenous shunt. Traditional pulse oximetry calculates the ratio of pulsatile absorption (AC) to mean absorption (DC) at each of the two wavelengths, 660nm and 905nm:

$$S(660) = AC(660) / DC(660)$$

$$S(905) = AC(905) / DC(905)$$

oximeter then calculates the ratio between these two pulse signals arterial absorption:

$$R = S(660) / S(905)$$

This value of R is used to find the saturation (SpO₂) in a verification table made by the oximeter software. The values of this table were obtained based on studies on human blood, performed with healthy adult volunteers, in situations of induced hypoxia.

The MS board of the Masimo SET pulse oximeter assumes that the arteriovenous shunt is highly variable in the floating absorption because the venous blood is a component of noise during the pulse. The

MS board decomposes S (660) and S (905) into an arterial signal, plus a noise component and calculates the arterial signal ratio without noise:

$$S(660) = S1+N1$$

$$S(905) = S2+N2$$

$$R = S1 / S2$$

Again, R is the ratio of two pulsed arterial absorption signals and its value is used to find SpO₂ saturation in an empirical derived equation in the oximeter software. The values in the empirical derived equation were obtained based on studies on human blood, performed with healthy adult volunteers, in situations of induced hypoxia.

The above equations are combined and a reference noise (N') is determined:

$$N' = S(660) - S(905) \times R$$

If there is no noise N'= 0: then S (660) = S (905) x R which is the same ratio as the traditional pulse oximeter.

The equation for reference noise is based on the value of R, at the value sought to determine SpO₂. The MS board software scans all possible R values that correspond to the SpO₂ values between 1% and 100% and generates a value N 'for each of these R values. Signals S (660) and S (905) are (ACC) that produces a power output versus a possible SpO₂ value as shown in the following figure where R corresponds to SpO₂ = 97%:

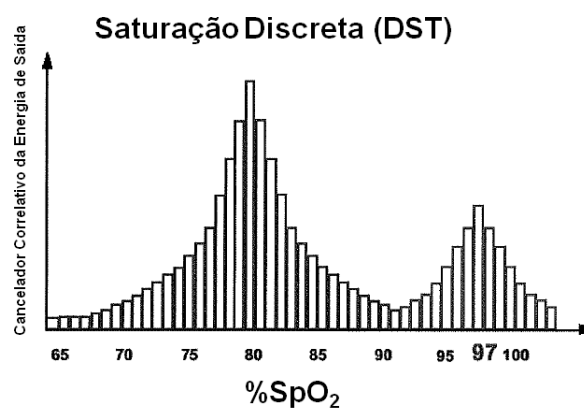

The DST curve has two peaks: a peak corresponding to the highest saturation is selected as the SpO₂ value. The entire sequence is repeated every two seconds in the most recent four seconds of the received data. Concluding the SpO₂ of the MS board, corresponds to the running evaluation of arterial saturation of the hemoglobin updated every two seconds.

12.3 Important Notices



WARNING

- *LNCS® oximeter probes were tested and validated with USpO2 MASIMO SET oximeter cables and the Fleximag Max family equipments in accordance with ISO 80601-2-61.*
- *The pulse oximeter is calibrated to display functional oxygen saturation.*
- *Risk of explosion. Do not use the MS pulse oximeter in the presence of flammable anesthetics or other flammable substances in contamination such as air, oxygen enriched environments or nitrous oxide.*
- *The pulse oximeter shall not be used as an apnea sensor, because is not an apnea monitor.*
- *The heart rate is based on the optical detection of the peripheral pulse flow and in this way may not detect certain arrhythmias. Therefore, the pulse oximeter should not be used as a replacement of ECG-based arrhythmia analysis*
- *A pulse oximeter can be considered a warning device. As an indicator of the patient's deoxygenation tendency, blood samples can be analyzed by co-oximetry laboratory to complete understanding of the patient's condition.*
- *The MS board of the pulse oximeter must be operated only by a qualified person.*
- *The manual, instructions for use and all precautions and specifications shall be read before use.*
- *There is danger of electric shock. Do not remove the monitor cover except for battery replacement.*
- *The operator may perform the maintenance procedures described in the product manual.*
- *Contact Magnamed service for oximeter repairs.*
- *As with all medical equipment, position the cable on the patient in order to reduce the possibility of entanglement or strangulation.*
- *Interfering substances:*
 - *Carboxyhemoglobin may erroneously increase readings. The level of increase is approximately equal to the amount of carboxyhemoglobin present.*
 - *Dyes or any substance containing dye, which change usual pigmentation of the artery may cause reading errors.*
- *Do not use the sensor during magnetic resonance (MRI) scanning:*
 - *Induced current can potentially cause burns.*
 - *The oximeter may affect the resonance image and the resonance unit may affect the oximetry measurements.*
- *If the fidelity of any measure does not seem reasonable, first check the patient's vital signs for alternative measures and make sure the oximeter is working properly.*
- *Before using, read the instructions for using the LNOP / LNCS sensors carefully.*

-
- **Use only Masimo oximetry sensors to measure SpO₂.**
 - **Damage to the tissue may be caused by improper application or misuse of LNOP / LNCS sensors.**
 - **Inspect the sensor location as directed in the instructions for use of the product to ensure skin integrity and correct positioning and adhesion of the sensor.**
 - **Do not use damaged LNOP / LNCS sensors.**
 - **Do not use LNOP / LNCS sensors with exposed optical components.**
 - **Do not immerse the sensor in water, solvents, or cleaning solution (sensors and connectors are not waterproof).**
 - **Do not sterilize by irradiation, steam or sterilization by oxides.**
 - **See the cleaning instructions in the instructions for use for reusable Masimo LNOP / LNCS sensors.**
 - **Do not use damaged cables.**
 - **Do not immerse the patient cable in water, solvents or cleaning solution (patient cables are not waterproof).**
 - **Do not sterilize by irradiation, steam or sterilization by oxides.**
 - **See the cleaning instructions in the instructions for use for reusable Masimo LNOP / LNCS patient cables.**
 - **Do not use the adult / pediatric sensor in neonate patients. It may cause incorrect measurements of physiological parameters.**
 - **Do not use the neonate sensor in adult / pediatric patients. It may cause incorrect measurements of physiological parameters.**

 - **Before use, the responsible company or the operator must verify the compatibility between the monitor, the probe and the cable, because when unattended it may result in patient injury.**
 - **The misapplication of a probe with excessive pressure for prolonged periods can induce pressure injury.**
 - **Do not use the IRMA Adult/Pediatric Airway Adapter with infants as the Adapter adds 6 ml dead space to the patient circuit.**
 - **Do not use the IRMA Infant Airway Adapter with adults/pediatrics as this may cause excessive flow resistance.**
 - **Possession or purchase of this device does not convey any express or implied license to use the device with unauthorized sensors or cables which would, alone or in combination with this device, fall within the scope of one or more of the patents relating to this device.**
 - **For more information about masimo patents: www.masimo.com/patents.htm**
 - **Inaccurate SpO₂ readings may be caused by:**
 - **Improper sensor application and placement**
-

-
- ***Elevated levels of COHb or MetHb: High levels of COHb or MetHb may occur with a seemingly normal SpO₂. When elevated levels of COHb or MetHb are suspected, laboratory analysis (CO-Oximetry) of a blood sample should be performed.***
 - ***Elevated levels of bilirubin***
 - ***Elevated levels of dyshemoglobin***
 - ***Vasospastic disease, such as Raynaud's, and peripheral vascular disease***
 - ***Hemoglobinopathies and synthesis disorders such as thalassemias, Hb s, Hb c, sickle cell, etc.***
 - ***Hypocapnic or hypercapnic conditions***
 - ***Severe anemia***
 - ***Very low arterial perfusion***
 - ***Extreme motion artifact***
 - ***Abnormal venous pulsation or venous constriction***
 - ***Severe vasoconstriction or hypothermia***
 - ***Arterial catheters and intra-aortic balloon***
 - ***Intravascular dyes, such as indocyanine green or methylene blue***
 - ***Externally applied coloring and texture, such as nail polish, acrylic nails, glitter, etc.***
 - ***Birthmark(s), tattoos, skin discolorations, moisture on skin, deformed or abnormal fingers. etc.***
 - ***Skin color disorders***
-
- ***Do not place the pulse oximeter or accessories in any position that might cause it to fall on the patient.***
 - ***Do not start or operate the pulse oximeter unless the setup was verified to be correct.***
 - ***To ensure safety, avoid stacking multiple devices or placing anything on the device during operation.***
 - ***To protect from electric shock, always remove the sensor and completely disconnect the pulse oximeter before bathing the patient.***
 - ***Do not adjust, repair, open, disassemble, or modify the pulse oximeter or accessories. Injury to personnel or equipment damage could occur. Return the pulse oximeter for servicing if necessary.***
 - ***Do not place the pulse oximeter where the controls can be changed by the patient.***
 - ***Electrical shock and flammability hazard: Before cleaning, always turn off the device and disconnect from any power source.***
 - ***When patients are undergoing photodynamic therapy they may be sensitive to light sources. Pulse oximetry may be used only under careful clinical supervision for short time periods to minimize interference with photodynamic therapy.***
 - ***If the Low Perfusion message is frequently displayed, find a better perfused monitoring***

site. In the interim, assess the patient and, if indicated, verify oxygenation status through other means.

- **Change the application site or replace the sensor and/or patient cable when a “Replace sensor” and/or “Replace patient cable”, or a persistent poor signal quality message (such as “LOW SIGNAL QUALITY”) is displayed on the host monitor. These messages may indicate that patient monitoring time is exhausted on the patient cable or sensor.**
- **To ensure that alarm limits are appropriate for the patient being monitored, check the limits each time the pulse oximeter is used.**
- **Variation in measurements may be profound and may be affected by sampling technique as well as the patient's physiological conditions. Any results exhibiting inconsistency with the patient's clinical status should be repeated and/or supplemented with additional test data. Blood samples should be analyzed by laboratory instruments prior to clinical decision making to completely understand the patient's condition.**
- **Replace the cable or sensor when a replace sensor or when a LOW SIGNAL QUALITY message is consistently displayed while monitoring consecutive patients after completing troubleshooting steps listed in this manual.**
- **The measurement instability of SpO₂ and the unrepeatability of the waveform is an indication of signal inadequacy which may affect the measurement accuracy of SpO₂ and heart rate, making it not reliable. It must be verified that the correct connection of the probe with the patient and wait for the stabilization of the SpO₂ measurement and wait for the waveform repeatability.**
- **A functional tester cannot be used to assess the accuracy of the pulse oximeter.**
- **When using the Maximum Sensitivity setting, performance of the "Sensor Off" detection may be compromised. If the device is in this setting and the sensor becomes dislodged from the patient, the potential for false readings may occur due to environmental "noise" such as light, vibration, and excessive air movement.**
- **Do not loop the patient cabling into a tight coil or wrap around the device, as this can damage the patient cabling.**
- **Additional information specific to the Masimo® sensors compatible with the pulse oximeter, including information about parameter/measurement performance during motion and low perfusion, may be found in the sensor's directions for use (DFU).**
- **Cables and sensors are provided with X-Cal™ technology to minimize the risk of inaccurate readings and unanticipated loss of patient monitoring. Refer to the Cable or Sensor DFU for the specified duration of the patient monitoring time.**
- **The pulse oximeter should not be used as the sole basis for medical decisions. It must be used in conjunction with clinical signs and symptoms.**
- **The pulse oximeter may be used during defibrillation, but this may affect the accuracy or availability of the parameters and measurements.**
- **The pulse oximeter may be used during electrocautery, but this may affect the accuracy**

or availability of the parameters and measurements.

- *The pulse oximeter should not be used for arrhythmia analysis.*
- *SpO2 is empirically calibrated in healthy adult volunteers with normal levels of carboxyhemoglobin (COHb) and methemoglobin (MetHb).*
- *Do not place the pulse oximeter on electrical equipment that may affect the device, preventing it from working properly.*
- *If SpO2 values indicate hypoxemia, a laboratory blood sample should be taken to confirm the patient's condition.*
- *If using pulse oximetry during full body irradiation, keep the sensor out of the radiation field. If the sensor is exposed to the radiation, the reading might be inaccurate or the device might read zero for the duration of the active irradiation period.*
- *To minimize radio interference, other electrical equipment that emits radio frequency transmissions should not be in close proximity to the pulse oximeter.*
- *High-intensity extreme lights (such as pulsating strobe lights) directed on the sensor, may not allow the pulse oximeter to obtain vital sign readings.*
- *To protect against injury, follow the directions below:*
 - *Avoid placing the device on surfaces with visible liquid spills.*
 - *Do not soak or immerse the device in liquids.*
 - *Do not attempt to sterilize the device.*
 - *Use cleaning solutions only as instructed in this operator's manual.*
 - *Do not attempt to clean the device while monitoring a patient.*
- *Loss of pulse signal can occur in any of the following situations:*
 - *The blood pressure cuff is inflated at the same extremity of where the SpO2 sensor attached.*

13 Technical Service



WARNING

- *FlexiMag Max is a life-support device and therefore, if any repairs or maintenance on this equipment is needed, only ask for an authorized Magnamed service.*
 - *Failure to perform the preventive maintenance may affect the safety and performance of the ventilator.*
 - *DO NOT OPERATE the equipment if it is not operating according to the specifications contained in this operating manual.*
 - *Before sending the equipment to the service technician, observe the cleaning and disinfection process RIGOROUSLY.*
 - *Magnamed will make available upon request the circuit diagrams, component list, descriptions, calibration instructions and other information required to perform an authorized service.*
-

14 Discard

The Fleximag Max ventilator shall be discarded as electrical and electronic equipment. Accessories and consumables must be disposed of as described in the instruction manual. Follow local government recommendations for proper disposal.

















WARNING









- *Dispose of the removable parts of the equipment in accordance with your institution's parts and pieces arrangement protocol.*
- *Follow local government recommendations for environmental protection, especially in cases of disposal of electronic waste or electronic parts.*
- *All parts of Magnamed ventilators that come in contact with patient fluids (e.g. breathing circuit) and that are potentially contaminated, are called semi-critical, and must endure a high-level disinfection or sterilization process before disposal (at the end of their useful lives) or before it is sent in for maintenance.*
- *When disposing of parts of Magnamed ventilators that come in contact with fluids from a patient, indicate as potentially infectious hospital waste.*
- *Disposal of batteries shall be in accordance with local regulations.*
- *Disposal of the galvanic cells shall follow local regulations.*
- *Airway adapters shall be disposed of in accordance with local regulations for medical disposal.*
- *Do not disassemble the equipment. All service or maintenance on the ventilator can only be carried out by qualified technician, trained and duly authorized by MAGNAMED.*
- *To discard the pulse oximeter, comply with local laws in the disposal of the device and/or its accessories.*

15 Symbology

15.1 Symbols used in the equipment

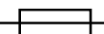







Table 63 - Symbols used in the equipment









Symbol	Description
	Preventive maintenance period
	Patient
	Equipment with applied part type B
	Equipment with applied part type BF
IP31	Degree of protection IP31 for protection against solid objects 2.5 mm in diameter or more and protected against falling drops
	EC Conformity: Indicates that the equipment complies with the European Council directive 93/42 / EEC for medical equipment
	Authorized Representative in the European Community
	Attention! Consult accompanying documents
	See operating instructions
	Separate collection of electrical / electronic equipment (do not dispose as ordinary waste)
	Manufacture Date
	Manufacturer's identification
	Gas inlet (AR / O ₂)
	On/Off
	Power connection
	Serial connection

Symbol	Description
	USB connection
	Network connection
	Alternating current
	Direct current
	DC Input - External Power Supply
	Fuse
	Identify or advise cleaning or filter change
	US federal law restricts this device to sale by or on the order of a physician.
	Consult documentation that came with the product.

15.2 Symbols used in packaging and labeling

Table 64 - Symbols used in packaging and labeling

Symbol	Description
	Fragile
	Direction of upper box face
	Keep protected from sunlight
	Keep protected from moisture
	Maximum Stacking Quantity
	Temperature limits
	EC Conformity: Indicates that the equipment complies with the European Council directive 93/42 / EEC for medical equipment
	INMETRO

Symbol	Description
	Single use part or accessory. Discard after use. Reprocessing is prohibited.
	Part or accessory not supplied sterile. Sterilize before use.
	Expiration date
	Do not use if packaging is damaged
	Manufacturer's Catalog Number
	Manufacturer serial number
	Manufacturer batch code
	Consult documentation that came with the product.

16 Abbreviations and Terms Used

Table 65 - Abbreviations and terms used

Abbreviation	Meaning
ΔPS	Support pressure delta (pressure above PEEP)
O_2	O_2 Concentration
PEEP	Positive end-expiratory pressure
Control Pr	Controlled pressure (pressure above PEEP)
Inferior Pr	Inferior pressure in APRV / DualPAP
Insp Pr	Inspiratory pressure (absolute pressure in neonatal mode)
Limit Pr	Limit pressure
Superior Pr	Superior Pressure in APRV / DualPAP
Fl Trigger	Flow trigger (for triggering)
Pr Trigger	Pressure sensitivity (for triggering)
T Inferior	Inferior Time in APRV / DualPAP
T Rise	Rise time (rise ramp)
T Superior	Superior Time in APRV / DualPAP
Ins Time	Inspiratory time
Minute Vol	Minute volume
Vol/weight	Volume by patient weight
NIV or VNI	Noninvasive Ventilation
$O_2 +$	Concentration of 50 to 100% O_2 for a certain time
O_2 100%	100% O_2 concentration for a certain time
MANUAL CYCLE or INSP MANUAL	Manual Cycle trigger
INSP HOLD	Inspiratory hold
EXP HOLD	Expiratory hold
Leakage	Percentage or leakage flow
Cdyn	Dynamic Compliance
Cstat	Static Compliance
E	Elastance
R Rate or f	Respiratory rate
Rate sp or fspont	Spontaneous respiratory rate
I:E	I: E Ratio
Pmean	Pressure Mean
Ppeak	Pressure Peak
Pplat	Plateau Pressure
RE	Expiratory resistance
RI	Inspiratory resistance
RSBi	Rapid Shallow Breathing Index (IRRS, Tobin Index)
TC	Expiratory Time Constant
Te	Expiratory time
Ti	Inspiratory time
Ti/Ttot	Reason for total inspiratory time
Vte or VTE	Total expired volume
Vte sp or VTE spont	Spontaneous total expired volume
Vti or VTI	Total Inspired Volume
MV or VM	Minute volume
MV sp or VM spont	Spontaneous minute volume
WOBi	Imposed Work of Breathing



WARNING

- *The controlled pressure setting (Pr Control) in pediatric or adult patients, refers to a relative pressure, that is, it adjusts the pressure value ABOVE PEEP.*
 - *The resulting inspiratory pressure will be the sum of the pressure controlled and PEEP.*
-

17 Biocompatibility Statement

We declare under our sole responsibility that all materials used in parts applied to Fleximag Max, such as silicone and polysulfide, have been widely used in the medical field over time, with no effects related to toxicity or tissue effects, ensuring their biocompatibility.



WARNING

- *Common accessories purchased from third parties SHALL be registered with local government.*

18 Warranty

The products manufactured and marketed by **MAGNAMED TECNOLOGIA MÉDICA S/A** are warranted against in material and manufacturer defects throughout Brazil, as described below.

The warranty period of the equipment is 12 months. For batteries and accessories, the period is 3 months, as long as their original characteristics are maintained, these terms begin from the date of acquisition by the first purchaser of the product, as indicated in the purchase receipt issued by MAGNAMED TECNOLOGIA MÉDICA S / A.

Warranty liability is limited to exchange, repair and labor for any parts that are defective or that do not meet the specifications contained in the Product Operation Manual.

The warranty is limited to the product which is used under normal conditions and for the intended purpose and whose preventive maintenance and replacement of parts and repairs are carried out according to the instructions in the Product Operation Manual by personnel authorized by the manufacturer.

The warranty does not cover defects caused by improper use or installation, accident, improper sterilization, service, installation, operation or alteration performed by personnel not authorized by the manufacturer.

Breakage or absence of seals or warranty seals by unauthorized personnel results in loss of product warranty.

Parts subject to wear or deterioration by normal use, adverse conditions of use, misuse or accidents are not covered under warranty.

Any expenses and risks with the transportation of the product are not covered by the guarantee.



For equipment sold with extended warranty, it will only be valid if the preventive maintenance suggested by Magnamed is carried out in accordance with chapter 9 of this manual.

There is no express or implied warranty other than as set forth above.

19 Training

To request training, contact Magnamed Product Specialist who will direct you to the nearest authorized representative. The training is performed in-loco and is expected to be executed in 1 hour.

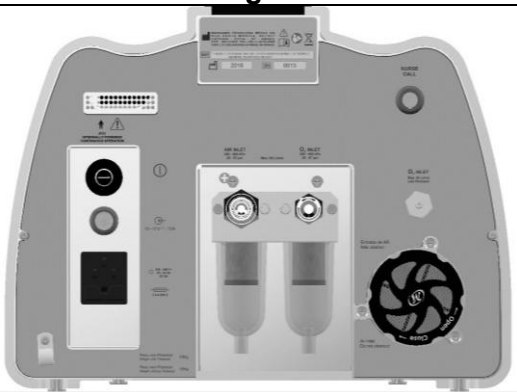
Annex I – Differences between models

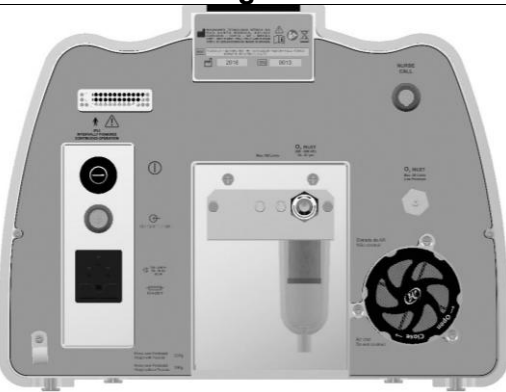
Specification	Fleximag Max 700	Fleximag Max 500	Fleximag Max 300
BACK VIEW			
FLOWAIR	YES	NO	YES
AIR PROPORTIONAL VALVE	YES	YES	NO
Alarm - FLOWAIR: Very High Temperature	YES	NO	YES
Alarm - FLOWAIR: HIGH TEMPERATURE	YES	NO	YES
Alarm - FLOWAIR: Failure	YES	NO	YES
Alarm - LOW AIR SUPPLY PRESSURE	YES	YES	NO
Alarm - HIGH AIR SUPPLY PRESSURE	YES	YES	NO

This product is only intended for use in pulmonary ventilation and shall be operated only by qualified professionals.

MAGNAMED

Manufacturer
Technical assistance
Customer Service



Rua Santa Mônica, 801, 831
06715-865 – Parque Industrial San José - Cotia – SP Brasil
Tel/Fax: +55 11 4615-8500
E-mail: magnamed@magnamed.com.br
Website: www.magnamed.com.br
CNPJ: 01.298.443/0002-54
State registration: 149.579.528.111

Technical Responsible: Toru Miyagi Kinjo
Inscription CREA-SP 5061555031
Legal Responsible: Wataru Ueda