

MAGNAMED

Operation Manual

Mechanical Ventilator
Fleximag Plus (display 15")

This operation manual refers to ventilator model FlexiMag Plus, developed and manufactured by Magnamed Tecnologia Médica S/A.

Revision of this operation manual: n° 14



Registration at ANVISA No. 80659160003

All rights reserved by:

Magnamed Tecnologia Médica S/A



Rua Santa Mônica, 801, 831

06715-865 – Parque Industrial San José -Cotia – SP Brasil

Tel/Fax: +55 11 4615-8500

E-mail: magnamed@magnamed.com.br

Website: www.magnamed.com.br

CNPJ: 01.298.443/0002-54

State Inscription: 149.579.528.111

Technical Responsible: Toru Miyagi Kinjo

Inscription CREA-SP: 5061555031

Legal Responsible: Wataru Ueda

Content

1 SAFETY ANNOTATIONS	7
1.1 DEFINITIONS	7
1.2 WARNING.....	7
1.3 ATTENTION	10
1.4 OBSERVATION	10
2 CHARACTERISTICS	11
2.1 INTENDED USE.....	11
2.2 FUNCTIONING PRINCIPLE	11
2.3 GENERAL CHARACTERISTICS	13
2.4 SAFETY CHARACTERISTICS	14
3 UNPACKING THE PRODUCT	15
3.1 INITIAL VERIFICATIONS	15
3.2 RELATION OF COMPONENTS OF FLEXIMAG PLUS.....	16
4 COMPONENT IDENTIFICATION	19
4.1 FRONT VIEW.....	19
4.2 BACK VIEW	20
5 PREPARATION FOR USE.....	21
5.1 ASSEMBLY	21
5.2 CONNECTION TO POWER SUPPLY	28
5.3 VERIFICATIONS BEFORE USE.....	29
6 USE INSTRUCTIONS	31
6.1 INITIAL SEQUENCE	31
6.2 ADJUSTMENT BUTTONS	34
6.3 MAIN SCREEN	35
6.3.1 Bargraph or patient menu area	35
6.3.2 Menu and graph area	36

6.3.3 Information Area.....	37
6.3.4 Menu selection area.....	37
6.3.5 Alarm panel.....	38
6.3.6 Alert panel.....	38
6.3.7 Ventilatory mode area	38
6.3.8 Options area.....	38
6.3.9 Mute alarm indicator	38
6.3.10 Quick access function area.....	39
6.3.11 Permanent monitor display area	40
6.3.12 Area of adjustable parameters	41
6.4 SETTING THE VENTILATION	42
6.4.1 Ventilatory modes available	42
6.4.2 Ventilatory modes adjust.....	43
6.4.3 Non-Invasive Ventilation (NIV).....	44
6.4.4 Ventilatory features	44
6.4.4.1 Volume x weight patient definition.....	45
6.4.4.2 Breathing circuit compensation	45
6.4.4.3 Automatic tube compensation (ATC)	45
6.4.4.4 External auxiliary pressure	46
6.5 AVAILABLE MENUS.....	46
6.5.1 GRAPH.....	46
6.5.2 MONITOR.....	47
6.5.3 ALARM	47
6.5.4 TREND	48
6.5.5 EVENTS.....	50
6.5.6 MANEUVER	50
6.5.6.1 P0.1	50

6.5.6.2 Slow Vital Capacity	50
6.5.6.3 P/V Flex	51
6.5.6.4 Max Pi.....	51
6.5.6.5 Gas Trapping Volume	52
6.6 CALIBRATIONS	52
6.6.1 <i>Distal flow sensor</i>	52
6.6.2 <i>Exhalation valve</i>	52
6.6.3 <i>O₂ cell (only galvanic cell)</i>	52
7 TROUBLESHOOTING	54
8 CLEANING, DISINFECTION AND STERILIZATION	56
8.1 EQUIPMENT CLEANING	56
8.1.1 <i>External Parts</i>	56
8.1.2 <i>Components</i>	56
8.1.2.1 Respiratory circuit, PROXIMAL flow sensor, silicone line and exhalation valve	56
8.1.2.1.1 Wash	56
8.1.2.1.2 Rinse.....	57
8.1.2.1.3 Drying.....	57
8.2 DISINFECTION.....	57
8.2.1 <i>External Parts</i>	57
8.2.2 <i>Respiratory circuit, exhalation valve, proximal flow sensor and silicone line</i>	57
8.2.3 <i>DISTAL flow sensor (Envitec SpiroQuant A+)</i>	57
8.2.4 <i>IRMA CO₂ sensor</i>	58
8.2.5 <i>Oximetry sensor (oximeter)</i>	58
8.3 STERILIZATION	58
8.3.1 <i>Steam sterilization</i>	59
8.4 IMPORTANT ADVICES.....	59
8.5 PROCESSING METHODS.....	60

9 PREVENTIVE MAINTENANCE	62
9.1 VERIFICATIONS	62
9.2 SCHEDULE PREVENTIVE MAINTENANCE	63
9.3 INTERNAL BATTERIES.....	63
9.4 WATER COLLECTORS WITH COALESCING FILTER	63
9.5 O ₂ CELL.....	64
10 PIECES AND ACCESSORIES OPTIONAL.....	66
11 TECHNICAL SPECIFICATIONS.....	69
11.1 EQUIPMENT CLASSIFICATION	69
11.1.1 Risks	69
11.1.2 Electrical isolation	69
11.1.3 Mode of operation	69
11.1.4 Protection against liquid penetration	69
11.2 APPLICABLE STANDARDS	69
11.4 ELECTRICAL SPECIFICATIONS	71
11.4.1 Power Supply.....	71
11.4.1.1 External Power Supply AC (power grid)	71
11.4.1.1 Internal Power Supply (battery)	71
11.4.1.1 External Power Supply DC	72
11.4.2 Connectors	72
11.5 PNEUMATIC SPECIFICATIONS	73
11.5.1 Pneumatic Chart	73
11.5.2 Gas inlet connections	74
11.6 INTERNAL FLOW TRANSDUCER SPECIFICATIONS	75
11.7 DISTAL FLOW SENSOR SPECIFICATIONS.....	76
11.8 PROXIMAL FLOW SENSOR SPECIFICATIONS (OPTIONAL).....	76
11.9 MASK FOR NON-INVASIVE VENTILATION.....	77

11.10 BREATHING CIRCUIT	77
11.11 VENTILATION MODES SPECIFICATIONS.....	78
11.11.1 VCV.....	78
11.11.2 PCV.....	80
11.11.3 PLV	82
11.11.4 PRVC.....	84
11.11.5 V-SIMV	86
11.11.6 P-SIMV.....	89
11.11.7 CPAP/PS	92
11.11.8 DualPAP	95
11.11.9 APRV.....	98
11.11.10 MMV - Mandatory minute ventilation.....	100
11.11.11 VS	101
11.12 ADJUSTABLE PARAMETER SPECIFICATIONS	102
11.13 MONITORED PARAMETER SPECIFICATIONS	105
11.14 SPECIFICATIONS OF ALARM AND SAFETY SYSTEM.....	107
11.14.1 Specifications of adjustable alarms.....	109
11.14.2 Messages of Ventilator Alarm.....	110
11.14.3 Messages of Ventilator Alerts	113
11.14.4 Messages of IRMA CO ₂ sensor Alarm.....	113
11.14.5 Messages of oximeter Alarm	115
11.15 SPECIFICATIONS OF PERFORMANCE	117
11.16 SPECIFICATIONS OF EXPIRATORY LIMB RESISTANCE	117
11.17 SPECIFICATIONS OF MAINTENANCE AND CALIBRATION.....	118
11.18 SPECIFICATIONS OF IRMA CO ₂ SENSOR.....	118
11.19 ELECTROMAGNETIC COMPATIBILITY	121
11.19.1 Manufacturer declaration – Electromagnetics emissions.....	122

11.19.2	Manufacturer declaration – Electromagnetic immunity.....	122
11.19.3	Radiated Immunity.....	123
11.19.4	Electrical safety	125
12	IRMA CO₂ SENSOR (OPTIONAL)	126
12.1	INTENDED USE.....	126
12.2	USE INSTRUCTIONS.....	126
12.2.1	Sensor Assembly.....	126
12.2.2	Sensor Positioning	128
12.2.3	Sensor Reset Procedure.....	129
12.2.4	Information about the LED status	130
12.3	PREVENTIVE MAINTENANCE	130
12.4	CLEANING AND DISINFECTION.....	130
12.5	IMPORTANT NOTES	130
13	PULSE OXIMETER (OPTIONAL).....	132
13.1	INTENDED USE.....	132
13.2	PRINCIPLE OF OPERATION	132
13.3	IMPORTANT NOTES	134
14	TECHNICAL SERVICE	138
15	SYMBOLOLOGY	139
15.1	SYMBOLS USED IN EQUIPMENT.....	139
15.2	SYMBOLS USED ON PACKAGING AND LABELING	140
16	ABBREVIATIONS AND USED TERMS.....	142
17	BIOCOMPATIBILITY DECLARATION	144
18	GUARANTEE	145
19	TECHNICAL ASSISTANCE	146
20	TRAINING	147

1 Safety Annotations

1.1 Definitions



WARNING

- *Informs the user of the possibility of lesion, death, or other serious adverse reactions associated to the use or misuse of the equipment.*
-



ATTENTION

- *Informs the user of the possibility of equipment failure associated to use or misuse, such as the equipment's malfunction, damages to the equipment, or damages, and, indirectly, to patient lesion.*
-



Observations

- *Important information.*
-

1.2 Warning



WARNING

- *Whenever the  symbol is found, read the instruction manual for further details.*
 - *This manual shall be fully and carefully read to that equipment to be used in a correct and safety manner, providing maximum safety and better resources to patients. Observe all Warnings and Attentions contained in this manual and on the equipment's labels.*
 - *This equipment must only be used for the specified purpose in the Intended use (chapter 2.1) together with the appropriate monitoring.*
 - *The equipment must be operated by qualified professionals, which must maintain*
-

vigilance during use. Including ventilations limited to volume.

- *Explosion Risk – This equipment is not approved for the use of flammable anesthetic agents.*
- *The equipment must be adversely affected and suffer interferences with certain transmission equipment, such as: cellular phones, walkie-talkies, cordless telephones, pagers, high-frequency surgical equipment (diathermy), defibrillators, short wave therapy, that may interrupt the equipment's operation. Do not use these transmission devices near the ventilator.*
- *This equipment must not be used during an MRI (MTR, NMR, NMI), it could be interfered with, may cause adverse effects on the patient.*
- *The applied parts are resistant to defibrillation.*
- *Before the first use or after each patient's use, clean the equipment according to chapter 8.*
- *Turn on the equipment and realize basic verification and adjustment procedures – follow the instructions, according indicated in chapter 5.*
- *The Alarms and Warnings must be promptly attended to in order to maintain the equipment's operation and the patient's security.*
- *Do not use hoses or antistatic or electrically conductive tubes.*
- *Verify if the equipment is adjusted correctly before use.*
- *After the ventilation starts, verify if the ventilator parameters indicated by the monitor display are adequate.*
- *Use only MAGNAMED's accessories listed at this manual, in which they were tested and approved for jointly using with this equipment. Otherwise, the correct equipment's operation may be compromised.*
- *During the equipment's prolonged use in patients with excess secretion or in breathing system using a heated humidifier, the flow sensor's condition must be frequently verified.*
- *The equipment has an independent power supply and its own battery backup system.*
- *Connect an AC power cord to a three-pin socket NBR 14136:2002 (2P+T);*
- *Maintain the equipment connected to a power source even when it is turned off in order to maintain the internal batteries permanently charged;*
- *Completely recharge the batteries after use or after a long stocking period;*
- *The alarm battery recharge must be promptly attended to. Perform your recharge before the next use of the equipment, because any power outage can stop the operation.*

-
- *If after a long period of time using battery, occurs a LOW BATTERY alarm, provide an IMMEDIATE connection of the power cord to a power supply, if it is not possible, provide adequate ventilator support means and DISCONNECT the patient from ventilator.*
 - *The absence of obstruction is extremely important for the correct operation of ventilation monitoring. Therefore, it must be frequently verified during the patient's ventilation realization.*
 - *After usage, the ventilator breathing system components MUST be disinfected before their next use, whenever the same are reusable.*
 - *All of the equipment's parts that came into contact with fluids from the patients must undergo a high-level disinfection process or sterilization when discarded or be discarded as potentially infected medical waste.*
 - *All parts applied of FlexiMag Plus ventilators are made of nontoxic material, they are exempted of latex and do not cause irritation or allergy to the patient (biocompatibility).*
 - *The common use accessories, which are not exclusive to FlexiMag Plus, such as: masks, respiratory circuits, nebulizers, heated humidifiers, HME filters, among others, must comply with local legal government requirements.*
 - *Do not use the equipment if the problem cannot be solved.*
 - *Have a ventilation manual powered available, to use in the cases of: the battery to be completely depleted or, there is a lack of gas for the ventilator operation; or general failure of the ICU ventilator.*
 - *Always use officially approved oxygen cylinders and pressure regulator valves that attend to local legal government requirements.*
 - *In order for appropriate ventilation, take in account the ventilator breathing system's dead spaces while adjusting the ventilator, especially for small tidal volumes.*
 - *The ventilator must not be covered or positioned so that the ventilator's operation or performance becomes adversely affected.*
 - *When adding components to the ventilator breathing system or other components of subsets for the ventilator breathing system, the pressure gradient may increase through the ventilator breathing system measured in relation to the patient's connection port.*
 - *HME filter, HEPA filter and airway adapter are single use. The reuse of these accessories may cause cross contamination.*
-

1.3 Attention



ATTENTION

- *The ICU's ventilator does not emit electromagnetic waves which interfere during the operation of equipment in their proximity.*
 - *Perform annual periodical maintenance or according to the specified hours of usage, whichever comes first.*
 - *All of the Ventilator's service or maintenance can only be realized by a licensed, trained, and duly authorized technician by MAGNAMED.*
 - *Only use MAGNAMED specified parts, cables, sensors and filters. For purchase, please inform the codes presented in the corresponding chapter.*
-

1.4 Observation



Observation

- *Eliminate the equipment's removed parts according to the disposal protocol of parts and accessories of its institution.*
 - *Follow the local governmental recommendations regarding environmental protection, especially in the event of electronic waste or electronic accessories (for example, batteries).*
 - *MAGNAMED products' technical characteristics are subject to alterations without previous warning.*
-

2 Characteristics

2.1 Intended Use

FlexiMag Plus comprises a family of ventilators developed to supply invasive and non-invasive ventilatory support to patients with impairment of respiratory functions in intensive or semi-intensive care, post-operative care, post-anesthetic recovery (PAR) or intra-hospital transport.

FlexiMag Plus model serves neonatal low weight, pediatric and adult with morbid obesity patients.

2.2 Functioning Principle

FlexiMag Plus is an electronic and microprocessed lung ventilator, whose operating principle is based on the integration of the following modules:

- Pneumatic module (manifold)
- Electronic control module
- Electronic interface module

At the pneumatic module inlet, two valves regulate the pressure coming from the hospital line or gas cylinders, in order to assure the proper pressure range to the equipment.

After the pressure regulators valves, there are micro switches that constantly monitors the gas pressure, to guarantee that an insufficiency or absence of pressure of one or both gases, is immediately indicated through a priority alarm.

After the micro switches, proportional flow control valves, regulate the gas flow in such a way to guarantee that the volume and oxygen concentration are suitable to each situation.

After having the respective flows adjusted, the gases are mixed to allow the measurement of O₂ concentration and also the resultant flow.

The oxygen concentration measurement is made through a galvanic cell sensor or, optionally, through a paramagnetic cell.

The resultant flow measurement is made through a high precision internal mass flow sensor, that allow the reading without the need of calibrations and without pressure and temperature influence.

The patient exhaled flow is measured by a hot-wire external sensor, connected to the exhalation valve. Optionally, for the model FlexiMag Plus, this flow can be read through a proximal flow sensor connected to the output of the 'Y' piece close to the patient, for which the measurement is based on differential pressure between two points.

The system pressures are taken through existing points in the pneumatic module, which are connected to existing transducers in the electronic control module.

All these flow and pressure measurements are converted into digital signals by the electronic control module and serve to feed back the control algorithm continuously, ensuring a gradual and secure adjust of the respiratory process.

The pneumatic module also comprises safety valves, and the overpressure valve and the anti-asphyxia valve.

The input and output information are processed by the electronics module interface. The information entered by the operator via the touch screen or via button, are translated, interpreted and sent to the electronic control module for serial type communication through secure protocols. With this

information the ventilator sets the appropriate parameters to work in each different situation.

As receives information, the control module also sends to the interface module. All measured or calculated data is sent, also via serial, to the interface module. This module process and

displays this information to the operator in a friendly and intuitive way.

All risk situations that require operator intervention are analyzed by the control module and sent to the interface module that emits then, according to the degree of risk, alarms or alerts needed.

2.3 General Characteristics

- Complete ventilation platform, with low weight and volume, integrating the pneumatic and electronic modules.
- Graphical interface with high-resolution color screen (up to XVGA), touch and single button (spin and confirm) for data entry.
- Color display of 15 inches.
- Digital technology, with the last generation embedded processor, applied to the electronic control system flow and pressure.
- Graphical interface completely intuitive, allowing operations through the touch screen or spin and confirm button.
- Recording of all parameters used by the last patient, allowing the ventilator to shut down without the need for adjustments when turns it on.
- Reading the regulated gas pressure (O₂ and compressed air).
- No need to use regulator valves for O₂ and compressed air if the gas supply is within the pressure range specified in this manual.
- Flow and pressure readings in the breathing circuit.
- Precise reading of the O₂ concentration in the mixture of gases delivered through the galvanic cell, or optionally, non-consumable paramagnetic cell.
- Automatic altitude compensation.
- Single distal flow sensor for all types of patient.
- Proximal flow sensor (neonatal, pediatric and adult).
- Complete monitoring of various ventilation parameters.
- Quick access functions:
 - Standby Mode
 - Mute alarm
 - 100% O₂ or O₂ suction
 - Cycle for manual breath
 - Inspiratory pause
 - Expiratory pause
- Nebulizer synchronized with the patient's inspiration, volume and FiO₂ compensation by software that maintains the volume and FiO₂ adjusted.
- Tracheal Gas Insufflation synchronized with the expiration of the patient.
- Automatic weaning feature that when detect a particular sequence of inspiratory efforts suspends the backup ventilation and resumes the set ventilation mode.
- Trend graphs with memorization of events in the last hours of ventilation (up to 72 hours, depending on the model).
- BICOLOR LED as connection indicator to electrical supply; green when equipment is connected and blue when equipment is being supplied only by batteries.
- Input port to an electric power supply 100-240 VAC ~ 50-60 Hz.
- Input port to an external source 15 V / 4 A (optional).
- Connectivity with personal computer by means of standard output RS232.
- Remote assistance and diagnostics - Magnamed (ARM).



ATTENTION

- ***These equipments shall be operated only by qualified and properly trained professionals for their use.***

2.4 Safety Characteristics

- Anti-asphyxia valve to protect against failures in gas supply.
- Relief valve of 100 hPa, in compliance with basic standard of ventilators, avoiding possible overpressure in the respiratory circuit.
- Active overpressure valve to detect obstructions is activated to reduce the pressure in the patient circuit.
- The equipment has audiovisual alarms related to both equipment operating condition (technical alarms), as the ventilation process.
- Backup energy system that allows the equipment to run using batteries for about 3,5 hours¹.
- Speaker for alarms and alerts.
- High brightness RED LED for prompt alarm identification.
- Possibility of automatic adjustment of alarms.
- Option of autodiagnosis to check alarms, failures detection, leakage measurement, system resistance and compliance.
- Use of the equipment even in case of single gas failure (O₂ or compressed air)
- Resistance compensation of the endotracheal tubes (ATC).
- Compensation of breathing circuit volume/compliance.
- Leak Compensation, both in invasive as in non-invasive modes.
- Compensation of volume according to temperature and humidity (ATPD and BTPS).
- Option for proximal sensors (neonatal, pediatric and adult).
- Maneuver for patient respiratory evaluation (except neonatal): P0.1, slow vital capacity, P/V Flex, Pi Max (NIF) and gas trapping volume.
- Freezing and salvaging loops of ventilation.
- Graphical differentiation between inspiratory and expiratory phases, indication of mode (assisted, spontaneous or manual) and window period.
- Sigh adjustment in volume modes.
- Measurement channel of auxiliary pressure for possible use of esophageal balloon or carina pressure measurement.
- Event table.
- Possibility to print trend data, graphs and alarms via a personal computer.

¹ Depending on battery load and adjusted ventilation parameters

3 Unpacking the Product

3.1 Initial Verifications

Observation

- *If the packaging is damaged, please immediately report to the carrier responsible and to MAGNAMED.*
-

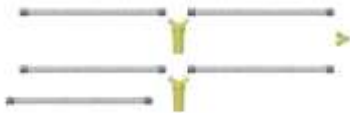

Table 1 – Initial Verifications

Stage	Procedure	Approved
1	Verify if the package is intact by looking for holes, or other damages.	<input type="checkbox"/> OK <input type="checkbox"/> NOK
2	Carefully open the package observing the box's indications	<input type="checkbox"/> OK <input type="checkbox"/> NOK
3	Check the package contents.	<input type="checkbox"/> OK <input type="checkbox"/> NOK

3.2 Relation of Components of FlexiMag Plus





The following items are integral part of equipment and are for exclusive use of it:

Table 2 - Components of FlexiMag Plus

Item	Part Number	Description	Qty	IMU	Image
1	1104970	FLEXIMAG PLUS – ADULT PEDIATRIC NEONATAL ELECTRONIC LUNG VENTILATOR 15 INCHES	01	PC	
2	1703038	RESPIRATORY CIRCUIT ADULT WITH WATER TRAP STRAIGHT Y ¹	01	PC	
3	1702667	ARTICULATED ARM WITH SUPPORT FOR RESPIRATORY CIRCUITS	01	PC	
4	3902647	O2 DISS X2 HOSE	01	PC	

¹ Accessories not available for European Union

Item	Part Number	Description	Qty	IMU	Image
5	3903114	COMPRESSED AIR DISS X2 3M HOSE	01	PC	
6	1703938	KIT 5 SENSORS SPIROQUANT ENVITEC CE 0123	01	PC	
7	2803779	FLOW SENSOR CONNECTION CABLE (EXTERNAL) CE 0123	01	PC	
8	3800248	MAGNAMED EXHALATION VALVE DIAPHRAGM	01	PC	
9	3804865	EXHALATION VALVE WITH STABILIZING RING	01	PC	
10	5003782	ASSEMBLY GUIDE	1	PC	-
11	9003608	ALLEN KEY 4 MM	1	PC	-
12	3005934	ALLEN SCREW HEAD SOCKET M6X25 WITH SEXTABLE INTERNAL STAINLESS STEEL	1	PC	-

Item	Part Number	Description	Qty	IMU	Image
13	2804669	AC POWER CORD MONTEO WITH 3 WAYS 3,0M – NEW NBR STANDARD 14136	01	PC	
14	110XXXX-NE-20-RR	OPERATION MANUAL	1	PC	
15	3505475	TEFLON CAP FOR AUTO TEST	1	PC	
16	1705043	KIT FLOW SENSORS ADU INF NEO AUTOCLAVABLE 1,6M <ul style="list-style-type: none"> • 03 Silicone lines • 01 Adult flow sensor • 01 Pediatric flow sensor • 01 Neonatal flow sensor 	01	PC	
17	7006466	QUICK GUIDE - FLEXIMAG	01	PC	-

4 Component Identification

4.1 Front view

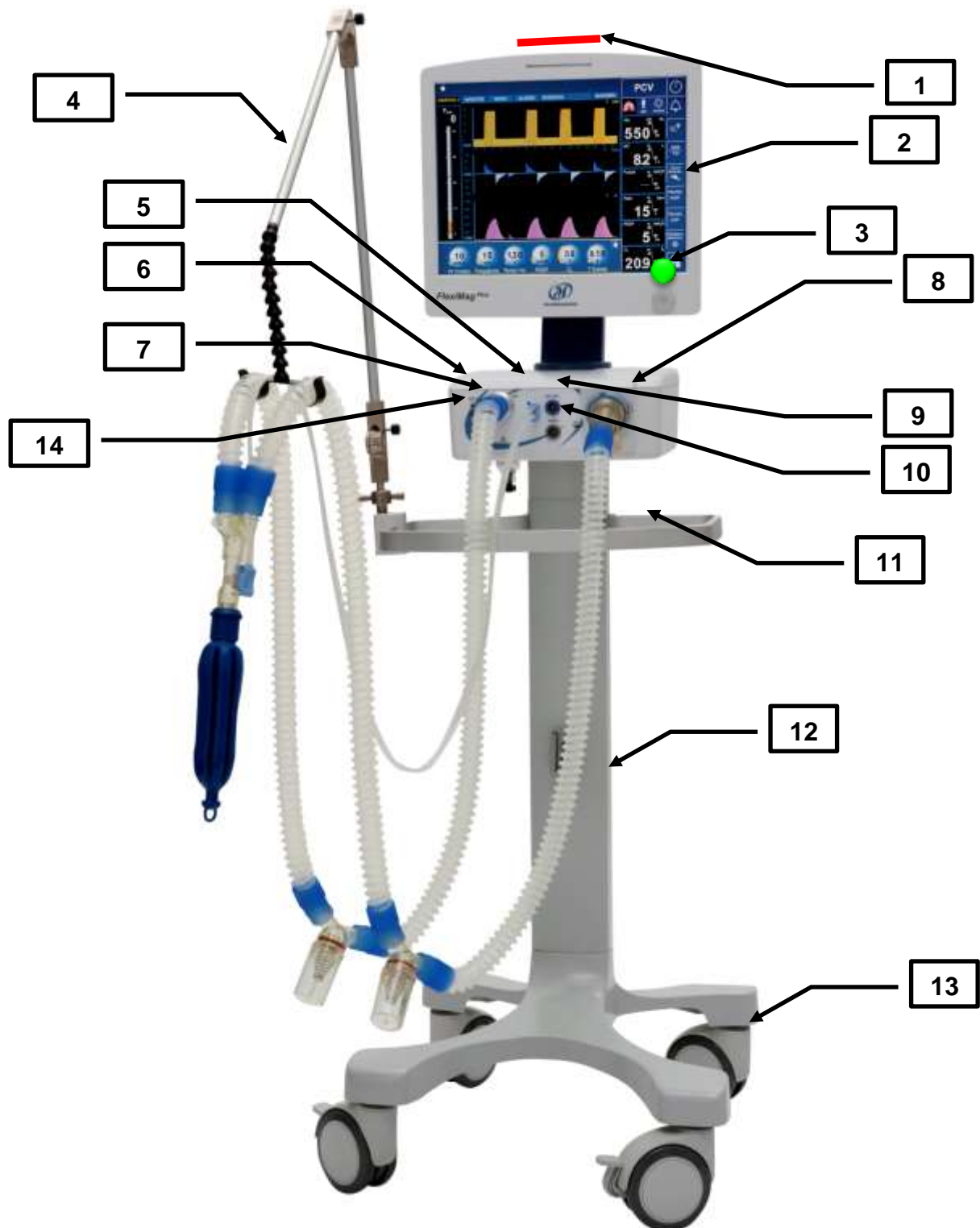

Figure 1- Front view

1. ALARM INDICATOR LIGHT – RED
2. LIQUID CRYSTAL DISPLAY WITH TOUCHSCREEN
3. SPIN AND CONFIRM BUTTON AND NETWORK POWER INDICATOR
4. ARTICULATED ARM
5. CONNECTIONS OF PROXIMAL FLOW SENSOR ⁽¹⁾
6. NEBULIZER / TGI
7. INSPIRATORY LIMB CONNECTOR
8. EXPIRATORY LIMB CONNECTION
9. CONNECTION OF DISTAL FLOW SENSOR
10. DISTAL FLOW SENSOR CABLE CONNECTOR
11. CARRYING STRAP
12. PEDESTAL
13. CASTORS WITH BRAKES
14. EXTERNAL AUXILIARY PRESSURE PORT

4.2 Back View

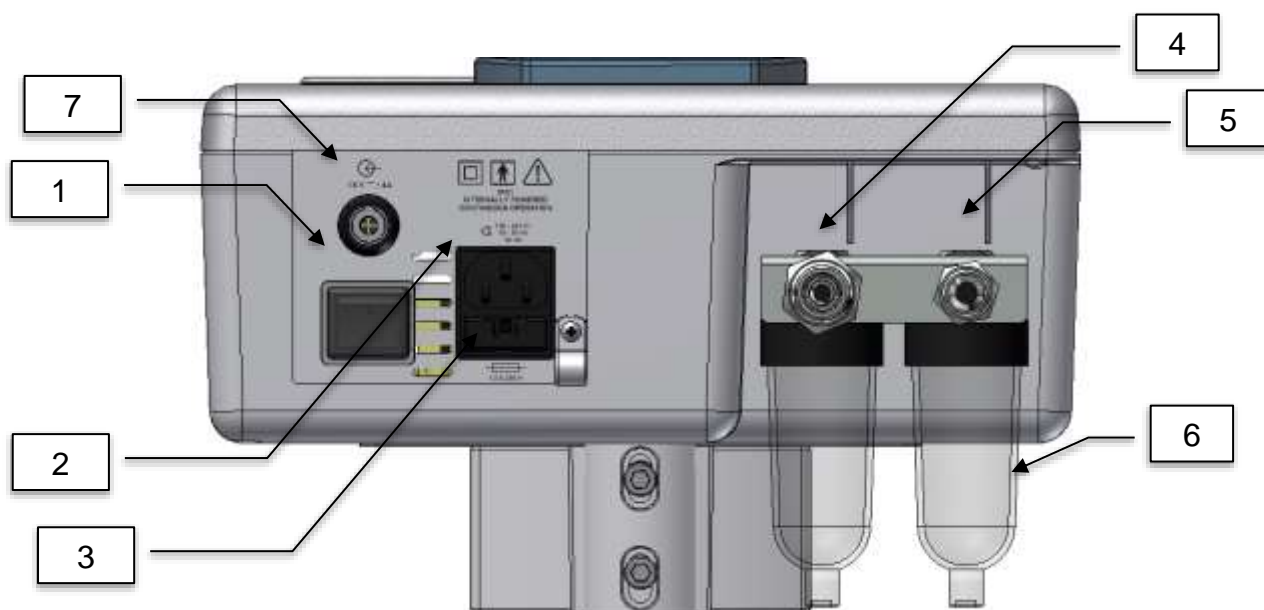





Figure 2 – Back View



1. On/Off Switch
2. Input of Electrical Power
3. Fuse holder
4. Inlet of Compressed Air
5. Inlet of Oxygen
6. Collectors of Water with Coalescing Filter for Gas under High Pressure
7. Inlet for Power External Source





5 Preparation for Use

5.1 Assembly



OK	Item	Assembly Sequence	Image
<input type="checkbox"/>	1	Use the four screws and key included with the equipment to screw the ventilator base with trundle.	-
<input type="checkbox"/>	2	<p>Position the diaphragm on the exhalation valve as shown in the figure.</p> <p>Position the exhalation valve locators on the base, press and rotate clockwise to lock.</p> <p>WARNING</p> <ul style="list-style-type: none"> • <i>Correctly position the diaphragm and the exhalation valve in order to avoid the expiratory limbs obstruction.</i> <hr/> <p>ATTENTION</p> <ul style="list-style-type: none"> • <i>To unlock the valve, press the base lock and turn the valve counterclockwise.</i> 	

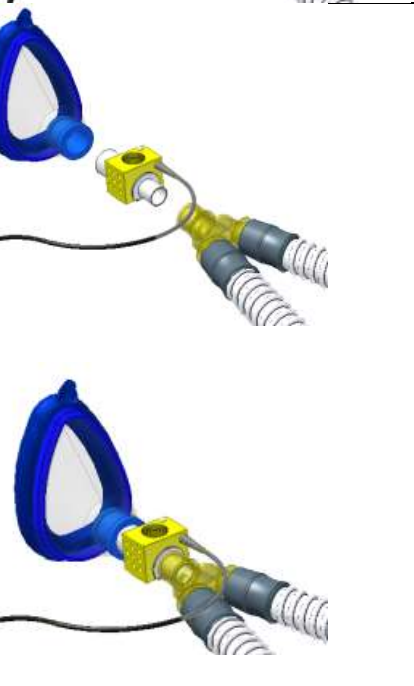
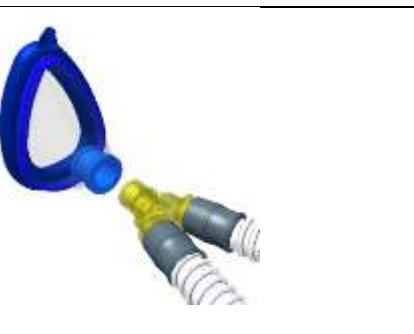

OK	Item	Assembly Sequence	Image
<input type="checkbox"/>	3	<p>Adequately connect the flow sensor and follow the instructions on the right.</p> <p>WARNING</p> <ul style="list-style-type: none"> <i>All connections must be mounted securely to prevent leakages.</i> 	
<input type="checkbox"/>	4	<p>Prepare the patient's respiratory circuit, firmly connection the inspiratory limb to the gas mix flow source.</p> <p>ATTENTION</p> <ul style="list-style-type: none"> <i>Use the respiratory circuit that is adequate to the patient.</i> 	

OK	Item	Assembly Sequence	Image
<input type="checkbox"/>	5	The expiratory circuit's limb must be firmly connected to the exhalation valve.	
<input type="checkbox"/>	6	<p>Assembly of proximal flow sensor:</p> <p>Connect the appropriate flow sensor according to the patient type and the respiratory circuit as indicated in the figure on the right.</p> <p>Connect the flow sensor line in the flow sensor as indicated in the figure on the right.</p> <div data-bbox="395 965 1011 1025" style="background-color: black; color: white; padding: 5px;">  ATTENTION </div> <ul style="list-style-type: none"> • <i>USE THE FLOW SENSOR INDICATED. The correct ventilation monitoring depends on the flow sensor used in the breathing circuit.</i> • <i>Even if there is need to use breathing circuits different from the patients to be ventilated, the FLOW SENSOR SHALL BE AS INDICATED.</i> 	

OK	Item	Assembly Sequence	Image
<input type="checkbox"/>	7	Connect the flow sensor line in the equipment as indicated in the figure on the right.	
<input type="checkbox"/>	8	<p>If using sensor of CO₂ (optional item), perform the mounting next to the flow sensor, as showed in the sequence of figures at the side.</p> <p>Connect the airway adapter to the CO₂ sensor and, afterwards, make a firm connection of the set to the flow sensor.</p>	
<input type="checkbox"/>	9	<p>In the event the respiratory circuit with CO₂ sensor and HME filter (Heat and Moisture Exchange), make the assembly according to the instructions presented in the image.</p> <div data-bbox="395 1742 1011 1800" style="background-color: black; color: white; padding: 5px;">  ATTENTION </div> <ul style="list-style-type: none"> • Use MAGNAMED specified HME FILTERS. 	

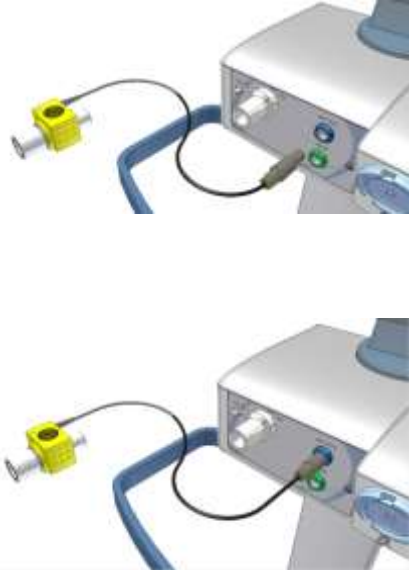
OK	Item	Assembly Sequence	Image
<input type="checkbox"/>	10	<p>In the event the respiratory circuit is used for NON INVASIVE VENTILATION (NIV) with masks, besides the filter and CO₂ sensor, follow the instructions on the image to the right.</p> <div style="background-color: black; color: white; padding: 5px; margin: 10px 0;"> <p>ATTENTION</p> <ul style="list-style-type: none"> • Use MASKS specified by MAGNAMED. • Use the adequate MASK for the type of patient. </div>	
<input type="checkbox"/>	11	<p>In the event the respiratory circuit is used for NON INVASIVE VENTILATION (NIV) with the use of mask and without the filter, follow the assembly on the right.</p>	
<input type="checkbox"/>	12	<p>In the event the respiratory circuit is used for NON INVASIVE VENTILATION (NIV) without filter.</p>	

OK	Item	Assembly Sequence	Image
			
<input type="checkbox"/>	13	<p>In the event the respiratory circuit is used for NON INVASIVE VENTILATION (NIV) with mask and HME filter, follow the assembly to the right.</p>	
<input type="checkbox"/>	14	<p>In the event the capnography sensor (CO₂) is used, connect the cable to the right lateral panel according to what is indicated in the illustration.</p> <div style="background-color: black; color: white; padding: 5px; margin: 10px 0;"> ATTENTION </div> <ul style="list-style-type: none"> • <i>The CAPNOGRAPHY connector has a BLUE indication.</i> • <i>Use the acquired CAPNOGRAPH by MAGNAMED.</i> 	

OK	Item	Assembly Sequence	Image
<input type="checkbox"/>	15	<p>If you are using the oximetry sensor:</p> <p>Connect the sensor cable to the front panel as shown.</p> <p>Position the oximetry sensor on the patient's finger.</p>	
<input type="checkbox"/>	16	<p>Connect the power cord to the equipment.</p>	

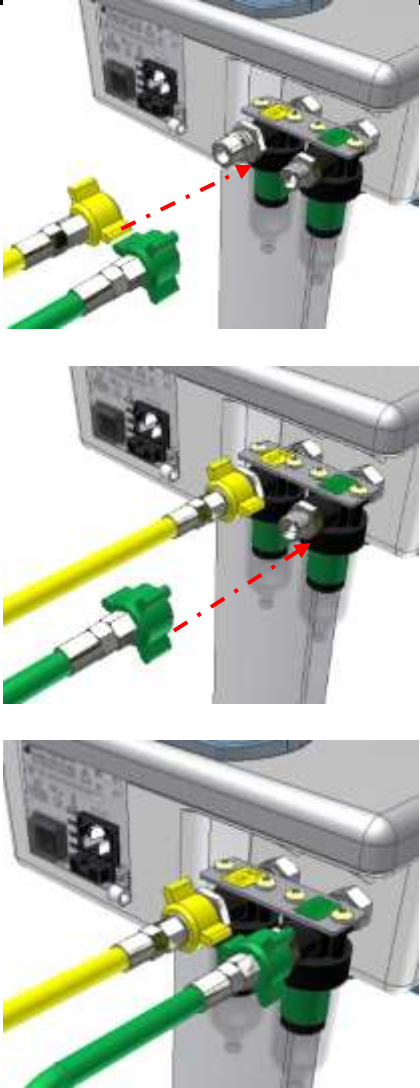
OK	Item	Assembly Sequence	Image
<input type="checkbox"/>	17	<p>Connect an Air hose in the indicated connection according to the illustration to the right (yellow).</p> <p>Connect an O₂ hose to the indicated connection according to the illustration to the right (green).</p> <p>The valve assembly of the pneumatic system prevents cross flow of gas.</p> <div style="background-color: black; color: white; padding: 5px; margin: 10px 0;">  ATTENTION </div> <ul style="list-style-type: none"> • <i>Pressures superior to upper limit can damage the equipment.</i> • <i>The gas supplies connected to the equipment must meet the requirements of ABNT NBR 12188:2012</i> 	

5.2 Connection to Power Supply

Batteries inside the equipment should always be charged and ready for use in an eventual failure of electric network supply for use in foreign operations. To do so, it must maintain its power supply plugged in to hold the batteries, even if the equipment remains turned off.

After prolonged use of the equipment with only the internal battery, the same must be completely recharged in order to prepare the equipment for the next use.

The battery must be completely recharged in the event the equipment remains disconnected from the electrical grid for over a month.

**WARNING**

- *If the ventilator usage is extended in battery, an alarm occurs whose message is **LOW BATTERY**, provide **IMMEDIATE** connection of the power supply to the network power supply. If it was not possible, **DISCONNECT** the equipment from the patient and provide appropriate means of ventilatory support.*

5.3 Verifications before use

The object of this inspection routine is to guide the user during a simple and fast procedure that consists of testing the equipment before each use, or, at least, at the beginning of each work period, guaranteeing more reliability.

Table 3: Verification before the use

Item	Procedure
1	Verify if the equipment is turned off.
2	Realize a visual inspection concerning the equipment and its components, looking to identify their intactness.
3	Verify if all of the equipment's components are correctly connected and inserted.
4	Verify a firm connection to the exhalation valve. It is important to verify the diaphragm's presence.
5	Verify a firm connection of the external flow sensor to the exhalation valve.
6	Check if breathing circuit is securely connected and is appropriate to the patient.
7	Check for secure connection of oxygen gas hoses and compressed air.
8	Check if gas inlet pressure is according to specification <div data-bbox="272 1574 1390 1630" style="background-color: black; color: white; padding: 5px;">  ATTENTION </div> <ul style="list-style-type: none"> • <i>Pressures above upper limit specification can damage the equipment</i> • <i>For inlet pressure below 250 kPa, the maximum flow will be 120 L/min</i>

9	<p>Verify a firm connection of the electric cord, when applicable. The ventilator can be used in battery operation up to 210 minutes continuously under normal ventilation of the patient.</p> <div style="background-color: black; color: white; padding: 5px;">  WARNING </div> <ul style="list-style-type: none"> • <i>If the ventilator usage is extended in battery, an alarm occurs whose message is LOW BATTERY, provide IMMEDIATE connection of the power supply to the network power supply. If it was not possible, DISCONNECT the equipment from the patient and provide appropriate means of ventilatory support.</i>
10	<p>If all items are check marked as OK, the equipment is ready for use.</p>

 **WARNING**

- *Perform all verification procedures before each use*
- *If any problem were identified, correct it **BEFORE USING THE EQUIPMENT***
- *If it was not possible to immediately correct the problem, call for authorized technical assistance.*

6 Use instructions

6.1 Initial sequence

Turn on the equipment using the ON/OFF button on the rear side of the equipment

After turning on the equipment the initial screen will be presented that include the patient and services available options, according to ventilator model.

On initial screen, select the patient type touching on the correspondent icon.

Once the patient is selected, requirements to perform the autotest will be presented:

- Ventilator shall be disconnected from the patient.
- Ventilator shall preferably be connected to electrical power supply or, if not possible, it shall have enough battery charge.
- Ventilator shall be connected to both pneumatic pressure sources (air and oxygen) under recommended pressure ranges.
- The LED red light that indicates priority alarms shall stay on.
- Shall be possible to hear the audible alarm test
- A BREATHING CIRCUIT, SUITABLE TO PATIENT TYPE, SHALL BE CONNECTED TO THE EQUIPMENT AND THE PATIENT CONNECTION SHALL BE CLOSED.



WARNING

- ***Never start autotest procedure with the equipment connected to the patient.***

Select the used humidifier type or heat exchanger and chosen flow sensor (distal or proximal).



ATTENTION

- ***The selection of humidifier or heat exchanger is important to the correct volume calculation according to presented temperature and humidity conditions (ATPD or BTPS).***
- ***If the proximal sensor were chosen, be assure it is in accordance to selected patient type (neonatal, pediatric or adult).***
- ***It will be tested only one type of external flow sensor, distal OR proximal. In case of wrong selection, restart the equipment and redo the autotest.***

If you really heard an audible alarm, answer YES to start the autotest. If not, answer NO. In this case the equipment shall not be used and therefore, it will be inoperative until the autotest is performed again.

To start the self-test, press the confirm button or, if you want to start the ventilation immediately, press the cancel button.



WARNING

- ***Never answer YES if you do not hear the sound test under the risk of bad functioning of priority alarms during ventilation.***
- ***Always perform the self-test procedure before connecting the ventilator to a patient.***

The autotest performs a verification of all important items for a safe ventilation:

- Regulated pressure
- Proportional valves
- Flow sensors
- Exhalation valve
- O₂ cell
- Leakage
- Resistance and compliance of breathing system

At the end of the leakage test, THE BREATHING SYSTEM OUTLET SHALL BE RELEASED for the resistance test and when applicable, for the proximal sensor test.



ATTENTION

- ***Never forget to release the breathing system outlet before resistance test.***

Each one of the tests can be canceled by user decision, except the internal flow sensor test, whose good functioning is essential to safe ventilation.

To the other tests, even in case of failure or cancellation, the equipment can be used, however, this information will be recorded and alerts about the occurrence will be shown during ventilation.

 **ATTENTION**

- ***In case of recurring failure of one or more autotest items, suspend the equipment use until the problem is solved.***
-

Once the autotest process is finished, press PROCEED to go to ventilation screen.

If you have not chosen LAST PATIENT adjustments, after the ventilation screen is loaded, the VENTILATION OPTIONS screen will be shown.

If necessary, complete the ventilation adjustments according to options available on this screen (see Section 6.6).

Cancel Stand by mode by pressing and holding for one (1) second the respective button located on the Quick Access area (Section 6.5.10).

 **WARNING**

- ***When it is restarted, the ventilator will go into STANDBY MODE (STANDBY) and in this condition the patient is not being ventilated.***
-

6.2 Adjustment buttons

Adjustment	Procedure
Adjustment of ventilatory parameters	<p>For adjustment of ventilatory parameters, touch on the button corresponding to the parameter to be set, it will be selected (the color will change), allowing the modification of its value using the spin and confirm button.</p> <p>It is still possible to change the parameter value using the slider (adjustment bar), drawing the finger by this control.</p> <p>To confirm the set value, press the button again corresponding to the parameter or press the spin and confirm button (ENTER).</p>
Alarms adjustment	<p>To access the alarm settings screen, tap on the ALARM tab.</p> <p>If capnography or oximetry is connected to the equipment, alarms related to that device will be displayed.</p> <p>For setting the alarm, tap the button corresponding to the alarm to be set, this will be selected (the color will change), allowing the modification of its value using the spin and confirm button.</p> <p>It is still possible to change the alarm value using the slider (adjustment bar), drawing the finger by this control.</p> <p>To confirm the set value, press the button again corresponding to the alarm or press the spin and confirm button (ENTER).</p>



ATTENTION

- *If a new value were not confirmed, it will be discarded after 5 or 10 seconds of inactivity, depending on the ventilator model.*

6.3 Main Screen

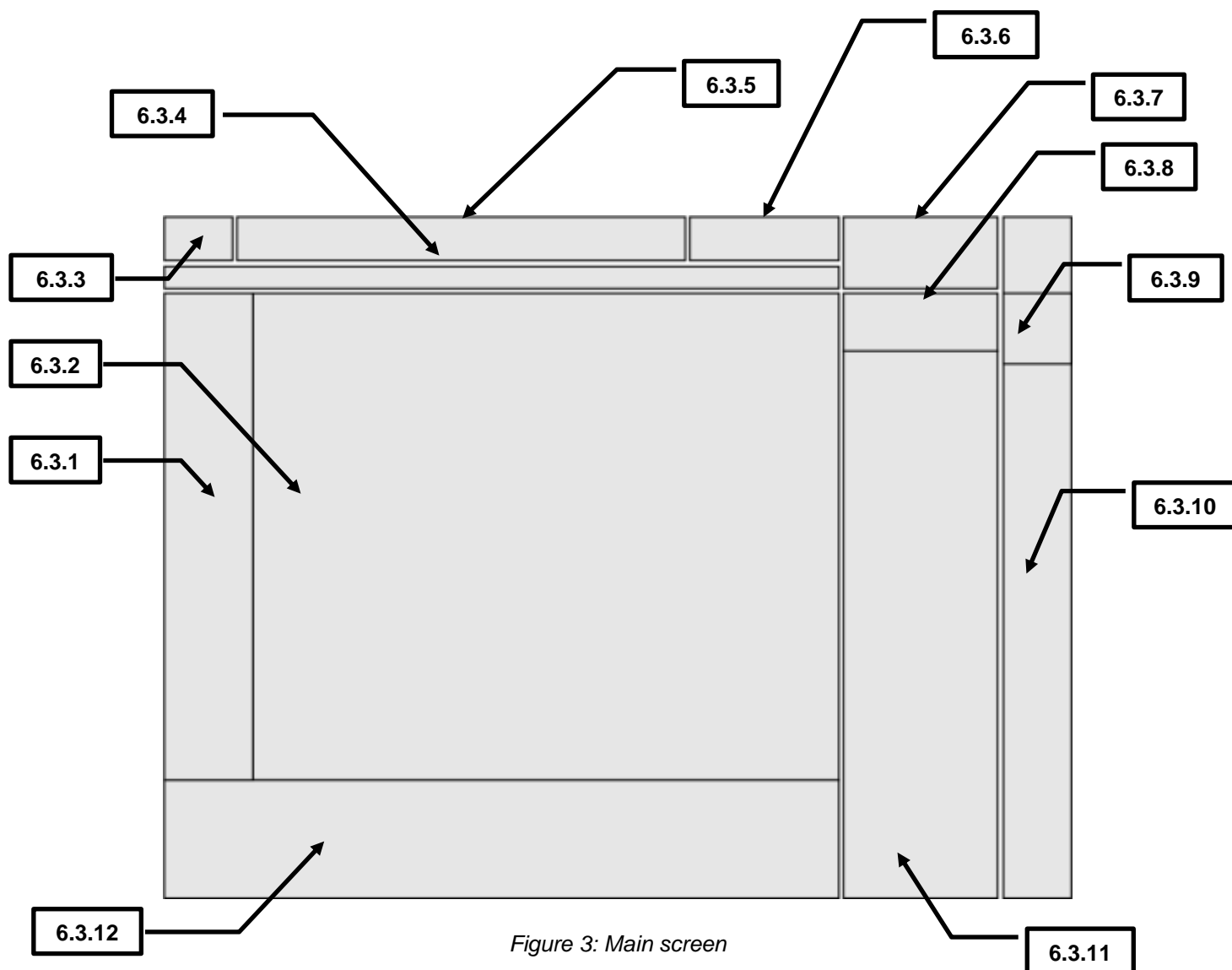

Figure 3: Main screen

6.3.1 Bargraph or patient menu area

Area where is displayed a bargraph, which indicates the instant value of the pressure through a color bar.

Above the bargraph there is a number indicator for pressure values that can be either peak pressure, plateau pressure or instant pressure. To change it, touch the displayed value.

If the displayed pressure where the instant pressure, when touching the screen, the bargraph is replaced by the patient menu, a monitor that shows the main ventilatory parameters related to patient: inspiratory and expiratory resistance, dynamic and static compliance and flow and percentual leakage.

To return to bargraph, touch the screen over de area once more.

Observation

- Always the capnography waveform (CO₂) or oximetry waveform (SpO₂) is visible, patient menu will be visible, but under this condition, it will also serve as a parameter monitor according to the connected sensor (capnography or oximetry).

6.3.2 Menu and graph area

On this area, graphs and some available menus area displayed.

To alternate between the graphs options, simply touch the screen over that area, when the GRAPHIC tab is active.

The window GRAPH Allows the selection of screen layout options, which determines the waveforms and / or loops that will be displayed.

- Pressure x Time, Flow x Time and Volume x Time
- Loop PV, Loop VF, Pressure x Time, Flow x Time and Volume x Time
- Loop PV, Loop VF, Loop PF, Pressure x Time
- Pressure x Time, Flow x Time and CO₂ OR SpO₂

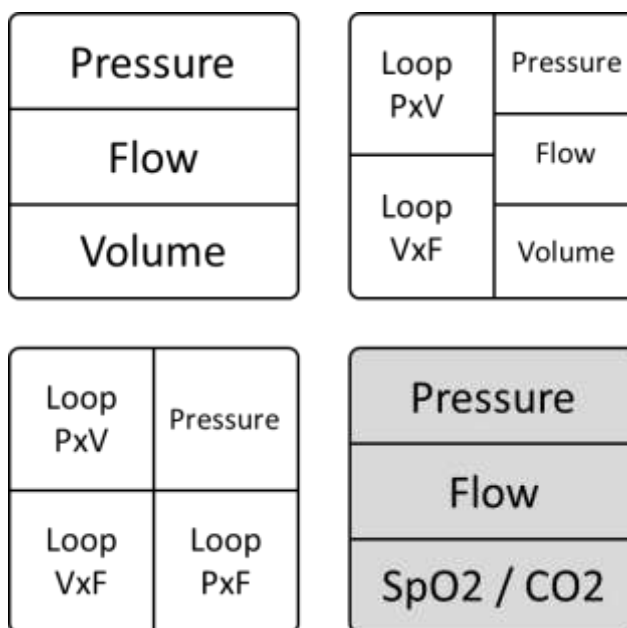

Figure 4 – Graph Layout





Through the window GRAPH it is possible to configure the speed in which the waveforms are drawn, filling and waveform scale.

Observation

- *There is a default automatic configuration of waveform draw and scale. To return to default configuration, choose automatic mode.*
- *When the ventilator is turned on, the draw speed and scale start in automatic mode.*

6.3.3 Information Area

Show if the equipment is connected to electric network or not. If it is not connected, an icon appears to indicate the battery load.

Icon	Description
	Charged battery and equipment connected to electrical network.
	Battery charging with equipment connected to electric network.
	Battery charged and in operation. Equipment disconnected from inoperant electric network or electric network.
	Battery partially charged and in operation. Equipment disconnected from electric network or inoperant electric network.
	Battery with minimum charge and in operation. Equipment disconnected from electric network or inoperant electric network. Low battery alarm can be activated.

Patient type is also indicated on this area.

6.3.4 Menu selection area

In this area are displayed and selected the available tabs and menus: GRAPH, MONITOR, MODE, ALARM, TREND, EVENTS and MANEUVERS.

6.3.5 Alarm panel

In this panel the active alarms are displayed.

High priority alarms are displayed in a red frame (danger), while the medium priority alarms are displayed in a yellow frame (attention), both flashing.

It may appear on that panel, the standby display or demonstration.

6.3.6 Alert panel

In this panel active alerts are displayed, such as triggers, autotest failures and others.

Advise to users also can be displayed when necessary. Examples: Blocked keyboard, Put in Standby and others.

6.3.7 Ventilatory mode area

Current ventilatory mode is displayed in this area. Besides, touching this button it is possible to access and configure all ventilatory modes and parameters.

6.3.8 Options area

The options area includes a representative lung icon indicating the respiratory cycles. It allows the operator to check whether the ventilator is cycling, i.e., alternating inspiratory and expiratory phase.

In addition, there are two available buttons that give access to the windows for ventilation options (VENT OPTION) and general configuration (CONFIG GENERAL).

Ventilation options present in its window are detailed in section 6.6 of this manual.

In the general configuration window, it is possible to change the interface language, the pressure unit, in addition to defining the minimum time of inspiratory and expiratory pauses and the time for screen locking.

6.3.9 Mute alarm indicator

This indicator is displayed during the period when the audible alarm is muted (maximum 120 seconds).

Observation

- *If during this period a new alarm occurs, the muting will be automatically disabled.*
- *The muting time is set in the alarm menu, accessible via ALARM menu.*

6.3.10 Quick access function area

This area displays buttons that activate the functions of quick access:

Function	Description
STAND BY	<p>Enables or disables Standby mode.</p> <p>In standby mode, the alarms are stopped, and the ventilation is paused.</p> <p>As a matter of safety, to enable/disable the standby mode, it is necessary to press the corresponding button for 1 second to active it.</p>
MUTE ALARM	Keeps the alarms silenced for the time set in ALARM menu.
O ₂ +	<p>Keeps the oxygen concentration increased (50 to 100%) during the time adjusted by the operator (10 to 120 seconds).</p> <p>During this period, the high FiO₂ alarm will be disable.</p> <p>This feature can be used for procedures of pre and post-aspiration of secretions in the airways.</p>
NEB TGI	<p>It accesses the window to configure the nebulizer or TGI.</p> <p>To active the nebulizer, select the Nebulizer option, set the desired nebulizer time and press the PLAY button (>).</p> <p>To active TGI simply select the TGI option.</p> <p>To turn off both at any time, select OFF.</p>
MANUAL CYCLE	Manually shoots an inspiratory cycle, as selected ventilatory mode.
PAUSE INSPIRATORY	<p>Allows inspiration suspension maneuvers, widely used in the case of X-ray of the chest.</p> <p>By pressing and immediately releasing this button, the inspiration will be extended for a minimum period that is adjustable. Keeping pressed, the expiration will be extended for up to 30s.</p> <p>After this period, it will be possible to check the value of the static compliance in the monitors.</p>
PAUSE EXPIRATORY	<p>Allows extension expiration time maneuvers (prolonged expiration time).</p> <p>By pressing and immediately releasing this button, the expiration will be extended for a minimum period that is adjustable. Keeping pressed, the expiration will be extended for up to 30s.</p> <p>After this period, the intrinsic PEEP or iPEEP parameter value will be displayed in the monitor.</p>

Function	Description
<p style="text-align: center;">FREEZING OF GRAPHS (FREEZE)</p>	<p>Freezing the graphs' lines (curves and loops).</p> <p>When the graphs are frozen, it is available a cursor that may be moved by touching the screen or the button.</p> <p>If there is a loop in the screen, the frozen also allows besides the movement of a cursor, which visualize the overlapping of the current loops on the frozen loop.</p> <p>It is still possible to save a loop to view it later.</p>
<p style="text-align: center;">LOCKS OF KEYBOARD (LOCK)</p>	<p>Protection system against accidental change. Lock or unlock the touch screen. When commands are crashed on the display, press the button to unlock them IMMEDIATELY.</p> <p>To lock again simply press this button once or wait the adjusted time without touching the screen.</p> <p>The lock by time may be turned off in the general configuration window.</p>

Observations

- *If during the muting period occurs a new alarm, the muting will be disabled*
- *The nebulizer flow is synchronized with the inspiration (inspiratory flow) and has volume and FiO₂ compensation by software, that maintains the volume and FiO₂ adjusted.*
- *The TGI flow is synchronized with expiration and activated when the exhaled flow reaches 25% of the maximum peak flow expired. Its end is determined by the beginning of the next inspiratory cycle.*

6.3.11 Permanent monitor display area

On this area are displayed up to six parameters monitored at a time, which are always visible, regardless of which screen is selected.

To see more parameters, simply touch the screen on the area. In this case, there will be a page change, with the display of six parameters monitored.

On permanent monitor, it is still possible to check the value limits of the follow alarms: volume, minute volume, maximum pressure, frequency, PEEP and FiO₂:

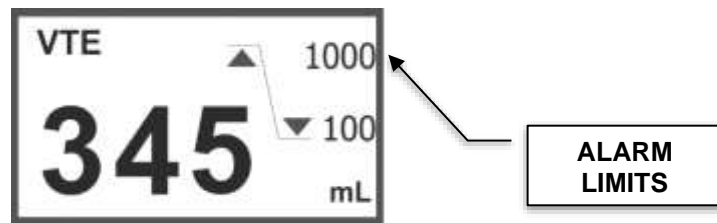

Figure 5 – Parameter Monitored

ATTENTION

- *If any adjustable alarm is active, touching the monitor on the corresponding parameter, there will be a direction to the alarm settings screen.*
- *Before resetting, make sure that the problem is just a wrong adjustment of the alarm limits.*

6.3.12 Area of adjustable parameters

In this area, the adjustable parameters are displayed as active ventilation mode. Six parameters are displayed by page.

To display the remaining parameters, simply touch the pagination arrows, without any active selection, and then hidden parameters are displayed.

To alternate a parameter, just tap on the parameter button desired. Once the button changes color, indicating your selection, values changes may be performed. To do so, simply turn the spin and confirm button clockwise to increase the value and counterclockwise to decrease it.

Confirms by pressing the spin and confirm button or touching the selected button.

6.4 Setting the ventilation

6.4.1 Ventilatory modes available

Table 4 - Ventilatory modes

Mode	Backup?	Backup Mode ⁽¹⁾		FlexiMag Plus	
		Neo	Ped and Adu	Neo	Ped and Adu
VCV	✓	—	Auto	✗	✓
PCV	✓	Auto	Auto	✓	✓
PRVC	✓	—	Auto	✗	✓
PLV	✓	Auto	—	✓	✗
PLV with VG ⁽²⁾	✓	Auto	—	✓	✗
V-SIMV	✓	—	Auto	✗	✓
P-SIMV	✓	Auto	Auto	✓	✓
CPAP/PS	✓	PLV Adjustable + Auto	VCV e PCV Adjustable + Auto	✓	✓
DualPAP	✓	PLV Adjustable + Auto	VCV e PCV Adjustable + Auto	✓	✓
APRV	✓	PLV Adjustable + Auto	VCV e PCV Adjustable + Auto	✓	✓
MMV	✓	—	VCV e PCV Adjustable + Auto	✗	✓
VS	✓	—	PRVC Adjustable + Auto	✗	✓

(1) For the ways in which the backup is set to "Auto" whenever the time set apnea is reached, the ventilator starts a ventilation cycle, whose configuration is based on the current ventilation mode settings.

(2) Guaranteed volume (VG) option.

Observation

- **GUARANTEED VOLUME** – Whenever you turn on the guaranteed volume option, make sure that the set pressure limit is sufficient to achieve the target volume, otherwise, the delivery volume may be lower due to pressure limitation (limited pressure alarm).
-

6.4.2 Ventilatory modes adjust

To change or reconfigure a ventilation mode, just tap on the button indicating active mode in the upper right corner of the screen. This button will change color and then the ventilation mode setting screen will be charged.

You can also access the Setup screen modes via the MODE tab.

Observation

- *Available ventilation modes will be determined as the ventilation model and the selected patient (see Table 4 - Ventilatory modes).*
-

To select a ventilation mode, simply tap on the tab with the abbreviation of the desired mode. Following, will be displayed all the adjustable parameters required for this ventilation mode, including the backup ventilation.

Observation

- *The setting of ventilation parameters (guard) is only available in spontaneous ventilation modes. In the other, the backup ventilation is automatic and considers the parameters set for the proper ventilation mode.*
 - *When the operator sets a pressure or flow trigger, the controlled modes (VCV, PCV, PRVC and PLV) will be monitored. In this case, that information will be displayed on the active mode button.*
-

After adjusting the parameters, so that these are activated, you must press the ENTER button.

To cancel the adjustments made and remain with the previous settings, including the ventilation mode, simply press the CANCEL button. Thus, the ventilator will ignore the settings made in this screen and return to the main screen.

6.4.3 Non-Invasive Ventilation (NIV)

Noninvasive ventilation (NIV) refers to the application of ventilatory support without invasive methods of the airways such as endotracheal intubation or tracheostomy. Nasal or oronasal masks are the most commonly used interfaces to the application of NIV in hospital.

In the application of NIV in controlled pressure modes, the pressure value should not be set to 0 (ZERO) and the cycle triggered by pressure must be active. The flow trigger remains disabled.

In NIV the ventilator automatically compensates higher leakage flows and ignores the high alarm minute volume, tidal volume and high verification of the flow sensor.

NIV is available for all ventilation modes and is accessible through the window ventilation options (VENT OPTIONS).



WARNING

- *The default values are just an initial reference.*
- *Readjust the parameters of ventilation as needed by the patient.*
- *Use the appropriate mask for each patient type in order to avoid excessive leakage.*



Observation

- *The flow trigger remains disabled during non-invasive ventilation.*
- *The controlled or support pressure (ΔPS) is a value above PEEP and may be adjusted between + 5 cmH₂O and P_{MAX}.*
- *Continuous flow, which apparently 'leaks' by the exhalation valve is normal and serves to reduce the time of the ventilation control system of the patient's response.*

6.4.4 Ventilatory features

For a more effective ventilation, once selected the patient, it is possible to opt for the adjustment of some ventilatory resources present in the VENT OPTIONS window.

6.4.4.1 Volume x weight patient definition

Once a patient is selected, the ventilator automatically estimates an adequate tidal volume. However, to obtain the best current volume is important to know the ideal weight for each patient.

It is possible to obtain the ideal weight according to sex and height of the patient. To do so, simply select the patient's sex and then adjust the height value, so that the equipment calculates your ideal weight.

The parameter setting volume by weight (ml per kilogram) complements the information necessary to better fit the current volume.

6.4.4.2 Breathing circuit compensation

Whenever leakage test performed in equipment startup is successful, the compensation of complacency and volume of the breathing circuit will be available.

Enable this option whenever you find that the volume and the compliance of the respiratory circuit are directly influencing the ventilation.

6.4.4.3 Automatic tube compensation (ATC)

The principal objective of this resource is to compensate for the work on the patient by the endotracheal tube.

Before activating this option, adjust carefully your setting by pressing the SET button ATC.



WARNING

- ***Wrong adjustment of the type and size of the endotracheal tube may cause damage to the patient.***

In ATC window, select the intubation mode and then adjust the diameter of all endotracheal and the percentage of compensation.

After making sure that the fit is appropriate to the patient close the configuration window and enable the tube compensation.

When you enable this option, it traced a new estimated pressure curve of the patient, with their instantaneous values.

This pressure value is estimated based on algorithms that take into account the diameter of the tube and the percentage of compensation.

The patient pressure curve read by the device remains drawn and normally tends to be larger than the estimated pressure.

6.4.4.4 External auxiliary pressure

In front of the ventilator, there is a channel for measuring external auxiliary pressure. To use this channel, plug one end of a suitable pipe in the auxiliary pressure nozzle (AUXILIARY P.) and the other end the pressure channel to measure.

It is possible to use this feature with an esophageal balloon or for the pressure of the carina, among other forms.

When you enable this option, a new pressure curve on the screen accompanied its instantaneous values will be drawn. The patient's pressure curve remains drawn normally.

6.5 Available Menus

The functionalities presented in FlexiMag Plus ventilators are arranged by menus, in order to facilitate the operation.

In this section, each of these menus shall be described, along with their respective features.

6.5.1 GRAPH

Allowing the access to what is considered the ventilator's main screen, because it allows to view the progress of the ventilation process, through graphs, bar graph of pressure and parameters monitored.

Available ventilation graphs:

- Pressure x Time Curve
- Flow x Time Curve
- Volume x Time Curve
- Pressure x Volume Loop
- Volume x Flow
- Pressure x Flow Loop
- CO₂ x Time Curve ¹
- SpO₂ x Time Curve ¹
- Instantaneous pressure bargraph with numeric indicator of peak pressure, plateau or instant.

^{1.} *This graph option is only available when one of the sensors (oximeter or capnograph) is connected*

6.5.2 MONITOR

Allowing the visualization of monitored parameters, in addition to those already displayed on permanent display area (area to the left of the screen)

Unlike the permanent monitor, which shows only six parameters at a time, the monitor menu is possible to display up to 28 parameters on the screen.

In this menu, it is still possible to select the page that is visible on permanent display. To do so, simply tap on one of the three columns of monitored parameters available.

6.5.3 ALARM

For each alarm directly related to the ventilation process, there are two limits (high value and low value) to be adjusted. These limits are configured directly in ALARM menu.

To make these settings, touch the button for the alarm corresponding to alarm to be set, and this one will be selected (the color will change), allowing the modification of its value using the spin and confirm button.

It is also possible to change the limits value of the alarm through the slider (adjustment bar), moving the finger by this control.

To confirm the set value, press the button again corresponding to the alarm or press the spin and confirm button (ENTER).

In this menu, it is also possible to adjust the maximum time allowed of patient apnea, which will determine the entry of backup ventilation.

There is also the option for auto setting of alarms and in order to enable, it is necessary that the ventilator is not in STANDBY (Standby mode) and preferably the ventilation is stabilized, seeking greater patient's safety.



WARNING

- ***Whenever restarted the ventilator or the type of patient was changed, alarm limits shall assume standard values, pursuant to the type of patient.***
- ***The apnea alarm time may be turned off. In this condition, BACKUP VENTILATION WILL BE NEVER ACTIVATED. Therefore, the operator must be sure that this adjustment is really necessary and aware of the clinical implications involved.***

-
- ***The automatic adjustment of alarm limits sets alarms for a percentage calculated on the value monitored during ventilation, thus, it may only be adjusted when the ventilator is NOT in standby mode (STANDBY) and preferably with an established ventilator condition.***
-

The alarm audio volume may also be changed. Just set the desired volume via the Alarms Audio Volume button.



ATTENTION

- ***Check that the set volume to audio alarms is available with the distance that the equipment will be from clinical body.***
-

6.5.4 TREND

The equipment records all events in the last 72 hours of ventilation, such as adjusted ventilatory parameters, main monitored values and all alarm conditions during this period.

It is possible to see the TREND curves up to 3 ventilation parameters simultaneously from the 13 parameters available for selection.

Once defined the parameters, adjust the range to which you want to see the trend.

This interval can range from 10 minutes to 72 hours with other options within that time period. The greater the range selected, the longer the time between events, or less details are shown.

Made the settings, just press the UPLOAD button.

While the equipment retrieves the requested data, a progress bar is displayed with the progress.

Once the data is loaded, the screen with the trend for the selected range will be displayed.

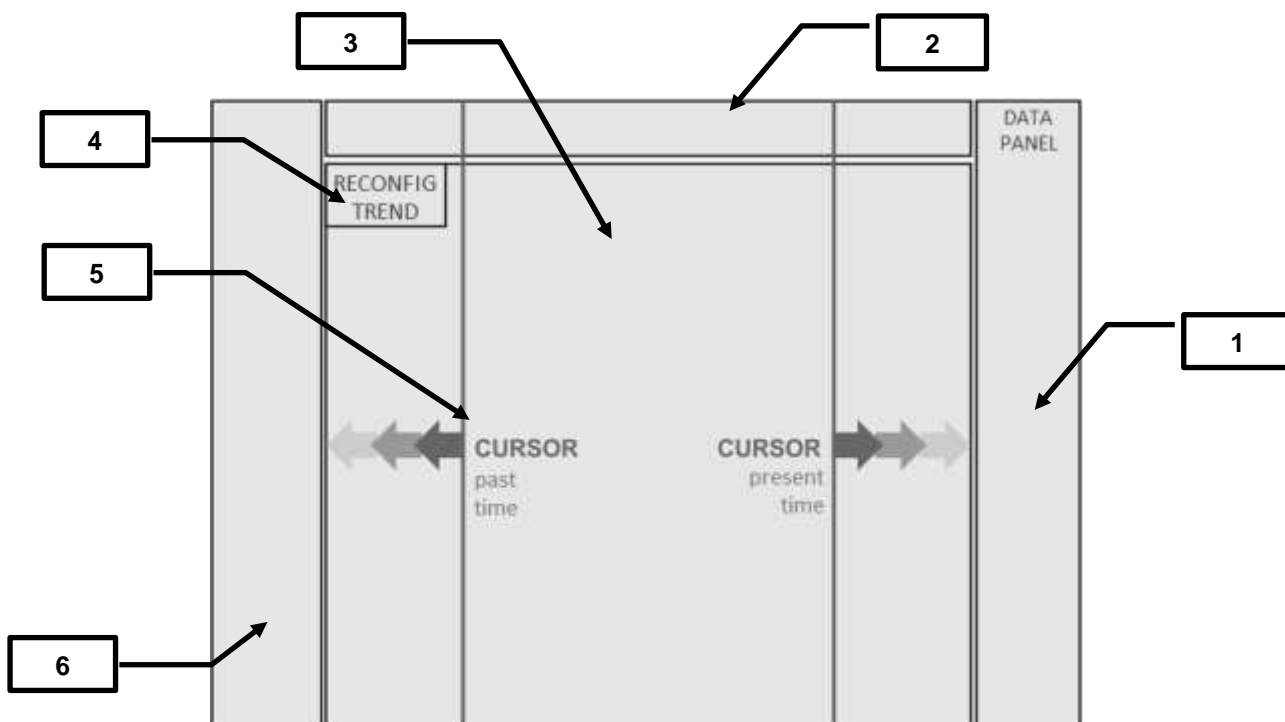

Figure 6: FlexiMag Plus Trend

1. Data Panel - Displays data about the position of the cursor on the timeline.
2. Event Panel - Indicates standby mode, alarm event or adjustments performed.
3. Screen Graph - Displays graphics up to 3 parameters selected.
4. Button to reconfigure trend.
5. Cursor – draws over the graph, allowing to analyze their points
6. Pressure Bargraph

A cursor is displayed to consult the data for different times along the timeline. This cursor may be moved both by the button rotates and confirms as the touch screen at the position you want to see.

Observation

- *To move the cursor on the trend graph, simply touch the screen to the desired position or rotate the spin and confirm button.*

The trend may go backwards in time through "pages" so that the previous data displayed are shown. To do so just move the cursor to the left edge of the screen where the trend has been traced.

Once the cursor touches the edge of the screen, a new "page" is loaded with older data, keeping the user-selected time range.

If you need to return to the previous screen, simply move the cursor to the right of the screen.

To reconfigure the trend, press RECONFIG TREND.

6.5.5 EVENTS

The EVENTS menu reflected in table format, the events during the trend interval that is loaded ON SCREEN. Therefore, it is only possible to access it if previously trend had set.

The ventilator may store more than 100,000 events over 72 hours in ventilation. In order to view them, you need to go making pagination in the TREND screen. For each trend page, it may be displayed in the table up to 120 events, divided into 3 pages.

6.5.6 MANEUVER

Except for neonatal patients, a MANEUVER menu is available. Basically, this provides some procedures for obtaining data on patient's respiratory mechanics.

6.5.6.1 P0.1

By definition, P0.1 index can be regarded as the fall of pressure generated by patient's inspiratory effort during the first 100 ms of the breathing process, i.e., once a certain pressure drops below the pressure baseline is established.

In the first stage of this procedure, the equipment analyzes some respiratory cycles, in order to identify the inspiratory and expiratory phases.

After this phase, the inspiratory limb occlusion occurs, so that after a certain pressure drop, the count of the first 100 ms is started while P0.1 is obtained.

6.5.6.2 Slow Vital Capacity

It is considered slow vital capacity, the ability to expire after a maximum inspiration by patient and serves as parameter for evaluating their ventilatory reserve.

To obtain this parameter, it is necessary that the patient is conscious, since their cooperation is essential.

For the maneuver performance, the ventilator will come into pure CPAP, without pressure support ($\Delta PS = 0$).

The patient shall perform successive breaths, extending inspiratory phase at the maximum and then, slowly expiring to the maximum possible extent.

The last measured value and the best of them will be displayed in the left frame of the VF loop.

6.5.6.3 P/V Flex

The inflection points of PV curve (pressure x volume) can be used to obtain the most suitable adjustments values for PEEP and plateau pressure.

By means of this resource, the upper and lower points of inflection are obtained, being the first one as basis for determining the optimum level of PEEP, while the second one serves as a parameter for the level of maximum pressure and adequate volume before a possible pulmonary hyper distention.

For this procedure, the patient shall be intubated without exercising respiratory efforts.

Initially, the operator must adjust the values of pressure, volume and flow appropriate to the patient and then press START.

The equipment will provide a constant flow known and it will monitor the instant pressure and volume.

Once one of the monitored parameters is reached, the flow is zero and the ventilator returns to cycle normally.

If the maneuver has been successful, the ventilator will display in the left frame: the maximum pressure and the affected volume, inflection points and the maximum compliance.

It will also be available a cursor, so the operator may get the inflection point graphically by tracing PV loop.

To move the cursor, just use the button rotates and confirms (do not touch on the graph).

6.5.6.4 Max Pi

Max Pi or NIF (Negative Inspiratory Force) is available only for spontaneous modes and serves for assessment of inspiratory muscle strength during weaning process from mechanical ventilation.

Before starting the maneuver, orient the patient to perform the maximum inspiratory effort when request.

Specifically, for this maneuver is necessary to keep the START button pressed during the entire process.

Started the maneuver, the value of PEEP will be temporarily reset and occur occlusion inspiratory branch.

The negative pressure values, for the patient's inspiratory effort, shall be measured until -60 cm H₂O limit.

The best value achieved, that is, most identified pressure drop, will be displayed in the left frame of the pressure graph.

6.5.6.5 Gas Trapping Volume

A volume of unwanted air can possibly be trapped in the lungs, in cases of lung hyperinflation and when the interval between breaths is not sufficient for patient's complete exhalation in order to reestablish the balance of respiratory system. And, especially, when the presence of intrinsic PEEP is detected.

To perform this procedure, the ideal is that patient does not exercise respiratory efforts. Therefore, it is recommended that the operator leads the patient, if it is conscious.

To make this maneuver, just press START and then each cycle occurred, the ventilator compares the volume target value (desired) and the value of the total volume achieved. If there is a difference, it will be displayed as trapped volume in the left frame of the layout flow graph.

6.6 Calibrations

It is recommended the calibration of some components before use in the following situations:

6.6.1 Distal flow sensor

- Replacement of distal flow sensor
- Active alarm with the message "CHECK FLOW SENSOR".

6.6.2 Exhalation valve

- Replacement of the exhalation valve.
- Replacement of diaphragm.
- Incorrect control of PEEP.
- Excessive leakage.

6.6.3 O₂ cell (only galvanic cell)

- Replacement of the cell.
- The monitored concentration values (FiO₂) do not seem correct.

- The lower and upper limits do not reach 21 and 100% O₂, respectively.
- Patient change.

Observation

- *To access the calibration screen, press the CALIBRATION button at the initial screen of the ventilator.*
-

7 Troubleshooting

This chapter presents principle problems and their possible solutions.

Problem	Possible Causes	Solutions
Low Battery Alarm	End of internal battery after usage without power source.	<i>Immediately re-establish the equipment connection to the power supply, or turn off the equipment and provide for another ventilatory supporting means to the patient.</i>
	Failure on system's internal battery, even with power source.	
Disconnection Alarm	Disconnect the respiratory circuit.	<i>Locate the disconnection and connect firmly.</i>
	Lack of Inspiratory Flow.	<i>Verify the existence of an inspiratory flow and increase it, if necessary.</i>
	Alteration of Patient's Respiratory Mechanics.	<i>Establish new parameters for ventilatory support.</i>
	Exhalation valve diaphragm mounted incorrectly or damaged.	<i>Place the diaphragm in the right position or substitute the diaphragm.</i>
	Failure on pressure control electronic system.	<i>Request Technical Assistance.</i>
Communication failure alarm	Electronic failure	<i>Request Technical Assistance</i>
High Pressure Alarm	Alteration of Patient's Respiratory Mechanics.	<i>Establish suitable parameters for the ventilatory support.</i>
	Obstruction of respiratory circuit's expiratory Limb or its exhalation valve.	<i>Unblock the circuit or reposition the respiratory valve diaphragm.</i>
	Obstruction of the patient's airways.	<i>Remove obstructions or aspirate the patient's airways.</i>
	Inspiratory pressure monitored is greater than expected.	<i>Check the setting of inspiratory pressure (absolute), whose value is the sum of the controlled pressure (relative) with PEEP.</i>
	Automatic Tube Compensation (ATC) is on. ⁽¹⁾	<i>Turn off or set to automatic compensation of the tube.</i>
Low Pressure Alarm	Alteration of Patient's Respiratory Mechanics.	<i>Establish new parameters for ventilatory support.</i>
	Excessive leakage on respiratory circuit.	<i>Locate leakage and correct it.</i>
Power Source Alarm	Disconnection from electric power cord.	<i>Immediately re-establish the equipment connection to the power supply, or use the equipment with internal battery for transport.</i>
	Failure in power grid.	<i>Re-establish the power supply.</i>
Inoperative Alarm	Electronic Failure	<i>Request for Technical Assistance.</i>

Problem	Possible Causes	Solutions
Breathing circuit compensation is not activated.	Leakage failure	<i>Restart the equipment and redo the self test</i>
Incorrect PEEP control	Exhalation valve calibration.	<i>Restart the equipment and calibrate the exhalation valve</i>
Curves and / or ventilation loops appear with scales or inadequate stroke speed.	Automatic adjustment of scales or graph speed off.	<i>Touch in the screen and select the automatic adjust at the corresponding window</i>
Curves and trend values do not appear or are incorrects	Failure in the clock system setting.	<i>Request for Technical Assistance</i>
Equipment does not start ventilation	Equipment in STAND BY	<i>Press the STAND BY button during 1 second to start the ventilation</i>
Test failure of proportional valves.	Pressure of the gas network below the lower limit.	<i>Check and reset the network pressure to reach the specified range.</i>
Test failure of distal flow sensor	The output of the breathing circuit was not occluded.	<i>Restart the equipment and redo the self test with the respiratory circuit closed</i>
Test failure of proximal flow sensor and resistance	The output of the breathing circuit was not released.	<i>Restart the ventilator and redo self test remembering to open the breathing circuit when prompted.</i>
Test failure of the exhalation valve	The output of the breathing circuit was not occluded.	<i>Restart the ventilator and redo the self test with the respiratory circuit closed.</i>
	The diaphragm of the exhalation valve is misplaced.	<i>Reposition the exhalation valve diaphragm, restart the machine and redo the self-test.</i>
Maneuvers not available	Neonatal patient selected	<i>Resources only available for pediatric and adult patients</i>
	Equipment in STAND BY mode	<i>Press the STAND BY button during 1 second to start the ventilation</i>
	Ventilatory mode not compatible with the resource	<i>Set an appropriate ventilatory mode as the desired resource</i>
It is not possible to see the events occurred	There is no trend curve loaded	<i>Select a trend interval before consulting the events</i>
The parameter setting returns to the previous value.	The adjust was not confirmed	<i>Confirm the adjust by pressing the button or by touching in the parameter</i>
Inspiratory or expiratory pause does not end as soon as the relevant button is released.	The minimum pause time set is higher than desired.	<i>Press the button CONFIG GENERAL and adjust the time.</i>
Audible alarm inoperative	Mute alarm is active	<i>Turn off the mute alarm</i>
	Electronic failure	<i>Request for Technical Assistance</i>
Backup is not active	Apnea time alarm is off	<i>Set an interval for apnea alarm</i>



WARNING

- ***Never use the equipment if a problem cannot be solved.***

8 Cleaning, Disinfection and Sterilization

It is important to establish a routine for cleaning, disinfection or sterilization of equipment and its components.

The following describes the main forms of cleaning, disinfection or sterilization according to the characteristics of each component and equipment.

8.1 Equipment cleaning

8.1.1 External Parts

External ventilator surfaces of Fleximag Plus should be cleaned with a clean, soft cloth moistened with the enzymatic detergent

Observations

- *Be careful to not accumulate residue in the connections of the equipment.*
- *For cleaning do not use non-compliant products to polymer.*

8.1.2 Components

The components that come in directly contact with respiratory gases must be periodically disassembled for cleaning, disinfection or sterilization.

8.1.2.1 Respiratory circuit, PROXIMAL flow sensor, silicone line and exhalation valve

Circuits and parts of silicone should be cleaned according the following steps:

8.1.2.1.1 Wash

- a) Always use potable water for this procedure;
- b) Use neutral and enzymatic detergent. Dilution should be performed as recommended by the manufacturer.
- c) Immerse the entire body of the flow sensor and the silicone line in the detergent solution, keeping the solution in contact with the accessories for at least 3 minutes;
- d) The external parts of the parts should be cleaned with a clean, soft cloth moistened with the enzymatic detergent. The internal parts must be cleaned by immersion.

8.1.2.1.2 Rinse

- a) Always use potable water for rinsing;
- b) Thoroughly rinse the external surface of the accessories with potable water.
- c) Rinse the internal surface by injecting potable water under pressure at least 5 times.



ATTENTION

- *Not to be used for cleaning or disinfecting the phenol (> 5%) ketone, formaldehyde, hypochlorite, chlorinated hydrocarbons, aromatic hydrocarbons, inorganic acids, and quaternary ammonium compounds.*
- *Never use saline solutions, especially sodium hypochlorite (bleach) and saline, disinfectants, hydrogen peroxide for cleaning or rinsing the accessories.*

8.1.2.1.3 Drying

Drying of the external parts should be done with a clean, soft and dry cloth and the drying of the internal parts should be done so that the solution drains by gravity.

8.2 Disinfection

8.2.1 External Parts

The external part should be disinfected using a clean cloth moistened with alcohol 70 °.

8.2.2 Respiratory circuit, exhalation valve, proximal flow sensor and silicone line

After cleaning, the items should be disinfected with alcohol 70°. The external part should be disinfected using a clean cloth moistened with alcohol 70 ° and internal part by immersion. Important: Do not soak the items to be disinfected with alcohol as it can damage the material.

After disinfection, the external parts should be dried with a clean, soft and dry cloth and the internal parts should be dried so that the solution drains by gravity.

8.2.3 DISTAL flow sensor (Envitec SpiroQuant A+)

For disinfection:

1. Disconnect the distal sensor from the exhalation valve and the connector cable and wait 30 minutes.

2. Immerse the sensor in 70% ethanol solution for 1 hour
3. Allow to dry naturally for 30 minutes in the environment before reassembly.



ATTENTION

- *The distal flow sensor must not be sterilized by steam.*
- *For the internal disinfection of DISTAL flow sensor, do not use tools that may generate mechanical forces, such as air or water jet, at the risk of damaging the filament.*
- *Drying of DISTAL flow sensor should occur naturally in ambient air, so avoid the use of compressed air or dryer.*
- *If there is a possibility of the sensor remain infected, replace it promptly.*

8.2.4 IRMA CO₂ sensor

The IRMA CO₂ sensor may be disinfected with a cloth moistened with 70% ethanol.



ATTENTION

- *The airways adapters IRMA CO₂ sensor are unsterile supplies, so the steam sterilization can damage these accessories.*
- *The airway adapter should not be reused.*
- *The reuse of a disposable adapter may cause cross infection.*
- *Never sterilize or immerse the IRMA CO₂ sensor in liquid.*

8.2.5 Oximetry sensor (oximeter)

Use the cleaning instructions as section 8.1.

8.3 Sterilization

- The components that get in touch with the respiratory gases must be removed for cleaning and sterilization;
- Do not use abrasive agents to carry out cleaning;
- Do not use alcohol to clean the plastic parts;
- Do not immerse the equipment in any liquid.

8.3.1 Steam sterilization

Perform the set sterilization as the autoclave manufacturer's recommendation.

Table 5 – Autoclavable accessories

Description	Autoclave cycles
Breathing circuit	50
PROXIMAL flow sensor	50
Silicon line	50
Exhalation valve	50
Diaphragm of exhalation valve	50

8.4 Important Advices



WARNING

- *Before first use, the equipment and its components must be cleaned, disinfected and sterilized as specified.*
- *All parts of MAGNAMED ventilators who have contact with fluids from the patient (ex. breathing circuit) are potentially contaminated, they are called semi critics and must undergo before being discarded (at the end of their life cycle) or sending maintenance service or repair, a high level of disinfection or sterilization process.*
- *In the case of disposal: INDICATE as medical waste potentially infected.*
- *By sending the ventilator for maintenance or repair services, to observe STRICTLY the disinfection process.*
- *Do not immerse the sensor in water, solvents, or cleaning solution (the sensors and connectors are not waterproof). Do not sterilize by irradiation, steam, or sterilization oxide. See the cleaning instructions in the instructions for sensors Maximum LNOP® / LNCS® reusable.*
- *Do not use damaged patient cables.*

ATTENTION

- *Accessories and removable MAGNAMED ventilator components is damaged or signs of wear should be replaced, avoiding use.*
- *The packaging of non-sterile devices (breathing circuits, expiratory connectors and valves) is designed to keep these products at the appropriate level of cleanliness to be sterilized before its use and also to minimize microbial contamination.*
- **Cleaning**
 - *Do not sterilize the oximeter by pressure, by gas or steam sterilization.*
 - *Do not soak or immerse the monitor in any fluid.*
 - *Use sparingly cleaning solution. The excess can drip inside the monitor and cause internal damage to components.*
 - *Do not use petroleum-based solutions, and other ketones harsh solvents to clean the oximeter. These substances attack your material and can cause problems to the device.*

Observations

- *Do not use abrasives to perform cleaning.*
- *Do not use alcohol to clean the plastic parts, except when specified.*
- *Do not immerse the ventilator in any liquid.*

8.5 Processing methods

Component	Processing methods		
	Steam Sterilization 135°C for 5 min	Antimicrobial Disinfectant	Alcohol 70%
Ventilator surface	x	✓	X
Touch screen	x	✓	✓
Silicone Breathing tube	✓	✓	✓
Silicone Pressure line	✓	✓	
Exhalation Valve	✓	✓	✓
Diaphragm	✓	✓	X

Component	Processing methods		
	Steam Sterilization 135°C for 5 min	Antimicrobial Disinfectant	Alcohol 70%
Proximal flow sensor (Adu, ped and neo)	✓	✓	✓
Distal flow sensor (Heated filament)	x	x	✓
SpO ₂ Sensor	x	✓	X
EtCO ₂ Sensor	x	✓	X

9 Preventive Maintenance



WARNING

- The symbol  displayed on the screen ventilator, it indicates that the equipment entered the preventive maintenance period. For the equipment ICU this period is 5,000 hours or 12 months, whichever occurs first.
 - Schedule preventive maintenance only by the technical service authorized MAGNAMED.
 - Before sending the equipment to the technical service note **STRICTLY** the process of cleaning and disinfection.
-

9.1 Verifications

The following verifications must be carried out daily and whenever the equipment is to be used:

- A. Cleaning equipment;
- B. Integrity of power source AC/DC converter;
- C. Operation of alarm systems, including audio;
- D. Filters Air/O₂ installed and unobstructed;
- E. LCD;
- F. Loaded Batteries;
- G. Touchscreen;
- H. Turn and confirm button;
- I. Correct respiratory circuit installation (including the exhalation valve diaphragm);



WARNING

- A daily check should be carried out with the disconnected ventilator of the patient.
-

9.2 Schedule Preventive Maintenance

MAGNAMED recommends performing preventive maintenance of ICU ventilators with your network authorized distributed by country. If you need more details, contact the MagnaService (Magnamed Technical Assistance).

9.3 Internal Batteries

These batteries are responsible for keeping the equipment working even with lack of power supply, lasting as specified for normal functioning in chapter 11.



WARNING

- *So that there is enough capacity battery during power failure electric, it is important that the equipment remains **WHENEVER POSSIBLE**, connected to a power grid.*





ATTENTION

- *So that the battery capacity in normal operation is full, should be replaced as indicated in the specification technique.*
- *The replacement of the internal batteries should be carried out by staff trained and qualified.*
- *Disposal of batteries should follow local legislation.*

9.4 Water collectors with Coalescing Filter

For removal of accumulated water, just press the pin found on the bottom of the collector.

To exchange the filter, consider the following sequence:

Instruction	Image
Remove the collector with oring	
Unscrew the filter	
Replace the filter and screw the new filter equipment	



ATTENTION

- *Do not expose the filter container incompatible materials polycarbonate.*
- *Replace the filter when it is clogged so it does not reduce the equipment input stream.*

9.5 O₂ cell

The FlexiMag Plus devices have two forms of measurement of oxygen concentration.

Galvanic cell - generates an electrical signal proportional to the concentration of oxygen in the gas mixture administered to the patient and the intensity of this electrical signal is due to the chemical reaction. This means measurement is consumable, and the life of the cell, according specification of the original manufacturer is 10,000 hours to 100% O₂, i.e. more than one year of continuous use. However, we recommend trading in maintenance preventive in 24 months schedule or 10,000 hours (whichever occurs first).

Cell Paramagnetic - generates an electrical signal proportional to the concentration of oxygen in the mixture gas administered to the patient and the intensity of this electrical signal is due to the torque created in the arrangement Magnetic cell. This sensor utilizes the paramagnetic susceptibility of the oxygen that distinguishes it from other gases. This method of measurement is not consumable.



ATTENTION







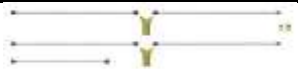

- *The galvanic cell for measurement of oxygen concentration should be replaced as indicated in chapter 11.15.*
 - *His replacement should be performed by trained and qualified personnel and their disposal must follow the local regulations.*
-

10 Pieces and Accessories Optional







ATTENTION

- Always use original parts and accessories to guarantee the equipment's security and efficiency.

Table 6 - OPTIONAL Pieces and Accessories

Item	Code	Description	Qty.	UMI	Image
1	1703037	RESPIRATORY CIRCUIT PEDIATRIC WITH WATER TRAP Y 90 ¹	01	PC	
2	1704601	RESPIRATORY CIRCUIT - ADULT 1.6M STRAIGHT Y AUTOCLAVABLE ¹	01	PC	
3	1704603	RESPIRATORY CIRCUIT - PEDIATRIC 1.6M Y 90 – AUTOCLAVABLE ¹	01	PC	
4	1703972	RESPIRATORY CIRCUIT SILICONE - ADULT 3.0M STRAIGHT Y ¹	01	PC	
5	3201100	ADULT FLOW SENSOR - AUTOCLAVABLE	01	PC	
6	3201099	INFANT FLOW SENSOR - AUTOCLAVABLE	01	PC	
7	3201098	NEONATAL FLOW SENSOR - AUTOCLAVABLE	01	PC	
8	3802058	SILICONE LINE 1,6 M WITH UNIVERSAL CONNECTOR	01	PC	

¹ Accessories not available for European Union

Item	Code	Description	Qty.	UMI	Image
9	1704396	CO2 MAINSTREAM SENSOR WITH INTERCONNECTION CABLE AND 5 ADULT AIRWAY ADAPTER CE 0413	01	CJ	
10	1704395	CO2 SENSOR ADULT AIRWAY ADAPTER CE 0413	25	PC	
11	1704394	CO2 SENSOR NEONATAL AIRWAY ADAPTER CE 0413	10	PC	
12	1704409	PULSE OXIMETER SPO2 MASIMO - ADAPTER CABLE AND PED-ADU SENSOR CE 0123	01	CJ	
13	1704410	PULSE OXIMETER SPO2 MASIMO - ADAPTER CABLE AND NEONATAL SENSOR CE 0123	01	CJ	
14	1404881	KIT NEBULIZER SET ¹	01	CJ	
15	1704415	HEATED HUMIDIFIER 110VAC WITH ADULT CHAMBER ¹	01	PC	

¹ Accessories not available for European Union

Item	Code	Description	Qty.	UMI	Image
16	1704416	HEATED HUMIDIFIER 220VAC WITH ADULT CHAMBER ¹	01	PC	
17	3905085	HEPA FILTER FOR MECHANICAL VENTILATION CE 2460	01	PC	
18	3905204	O2 DISS X2 5M HOSE	01	PC	
19	3905203	COMPRESSED AIR DISS X2 5M HOSE	01	PC	
20	1705143	HME FILTER STERILE CE 2460	01	PC	
21	2805611	CABLE ADAPTER REDEL TO INPUT EXTERNAL POWER 15V	01	PC	-

¹ Accessories not available for European Union

11 Technical specifications

11.1 Equipment Classification

11.1.1 Risks

- ✓ As Directive 93/42/CEE – Rule 9: Class IIb
- ✓ As MERCOSUL/GMC/RES. N° 40/00: Class III

11.1.2 Electrical isolation

- ✓ As ABNT NBR IEC 60601-1:1994
- ✓ Class II
- ✓ Applied part type BF
- ✓ Energized equipment internally
- ✓ Part applied to proof defibrillation

11.1.3 Mode of operation

- ✓ As ABNT NBR IEC 60601-1:1994
- ✓ Equipment for use in continuous operation

11.1.4 Protection against liquid penetration

- ✓ As ABNT NBR IEC 60601-1:1994
- ✓ Ingress Protection IPX1

11.2 Applicable standards

- **IEC 60601-1 (1988) + Amd. 1 (1991) + Amd. 2 (1995), IEC 60601-1-1 (2000) (EN 60601-1:2006 + A1:2013)** - Medical electrical equipment - Part 1: General requirements for basic safety and essential performance
- **IEC 60601-2-12: 2001 (EN 60601-2-12:2006)** - Medical electrical equipment - Part 2-12: Particular requirements for the safety of lung ventilators - Critical care ventilators
- **ISO 5359:2008/Amd 1:2011 (EN ISO 5359:2008+A1:2011)** - Low-pressure hose assemblies for use with medical gases
- **IEC 60601-1-2 Ed. 3.0 (2007) (EN 60601-1-2:2007)** - Medical electrical equipment - Part 1-2: General requirements for basic safety and essential performance - Collateral standard: Electromagnetic compatibility - Requirements and tests
- **IEC 62304:2006 +AMD1:2015 (EN 62304:2006/2008)** - Medical device software - Software life-cycle processes
- **IEC 60601-1-8 Ed. 2.0 (2006)/A1:2012 (EN 60601-1-8:2007/A11:2017)** - Medical electrical equipment - Part 1-8: General requirements for basic safety and essential performance - Collateral

Standard: General requirements, tests and guidance for alarm systems in medical electrical equipment and medical electrical systems

- **IEC 60601-1-4: 1996/A1:1999 (EN 60601-1-4: 1996/A1: 1999)** - Medical electrical equipment - Part 1-4: General requirements for safety - Collateral standard: Programmable electrical medical systems
- **IEC 60601-1-6: 2010 (EN 60601-1-6:2010)** - Medical electrical equipment - Part 1-6: General requirements for basic safety and essential performance - Collateral standard: Usability
- **IEC 62366: 2007 (EN 62366:2008)** - Medical devices - Application of usability engineering to medical devices
- **EN ISO 17665-1:2006** - Sterilization of health care products - Moist heat - Part 1: Requirements for the development, validation and routine control of a sterilization process for medical devices
- **EN ISO 17664:2004** - Sterilization of medical devices - Information to be provided by the manufacturer for the processing of resterilizable medical devices
- **EN 1041:2008** - Information supplied by the manufacturer of medical devices
- **ISO 15223-1: 2016 (EN ISO 15223-1:2016)** - Medical devices - Symbols to be used with medical device labels, labelling and information to be supplied - Part 1: General requirements
- **ISO 80601-2-61:2011 (EN ISO 80601-2-61:2011)** – Medical electrical equipment: Particular requirements for basic safety and essential performance of pulse ox equipment
- **ISO 80601-2-55:2011 (EN 80601-2-55: 2011)** - Medical electrical equipment -- Part 2-55: Particular requirements for the basic safety and essential performance of respiratory gas monitors

Table 7 – Physical and Environmental Specifications

Parameter	Specification	Tolerance	Unit
Dimensions and Weight (basic unit)			
a. Height	1335	± 5	mm
b. Width	453	± 5	mm
c. Depth (with handle)	542	± 5	mm
d. Weight	18	± 0,1	kg
Operation			
a. Temperature	-10 to 50	---	°C
b. Barometric Pressure	600 to 1100	---	cmH ₂ O
c. Relative air humidity (non-condensing)	15 to 95	---	%
Storage			

a.	Temperature	-20 to 75	---	°C
b.	Barometric Pressure	500 to 1200	---	cmH ₂ O
c.	Relative air humidity (non-condensing)	5 to 95	---	%
Life time				
	Fleximag Plus	10	---	years

11.4 Electrical Specifications

11.4.1 Power Supply

Fleximag Plus has the ability to operate over three distinct types of power supply.

11.4.1.1 External Power Supply AC (power grid)

Table 8 – External Power Supply AC

Item	Specification	Tolerance
Energy Source	Voltage: 100 to 240 V _{AC}	± 10%
	Frequency: 50 to 60 Hz	
	Fusible: 1,0 A 250 V	
Maximum Power Consumed	80 VA	± 10%

11.4.1.1 Internal Power Supply (battery)

Table 9 – Internal Power Supply

Item	Specification	Tolerance
Internal Battery	Type: Li-Ion	± 15%
	Voltage: 11,8 V _{DC}	
	Capacity: 4000 mAh	
Autonomy of internal batteries (with full load and normal use) ⁽¹⁾	210 minutes	± 15%

Average time to recharge to full load (operation module) ⁽¹⁾	4,0 hours	± 15%
---	-----------	-------

(1) The battery should be made at ambient temperature from 5 to 35 ° C

11.4.1.1 External Power Supply DC

Table 10 – External Power source DC

Item	Specification	Tolerance
Power Supply ⁽¹⁾	Voltage: 12 to 15 V _{DC}	± 10%
	Current: 4 A	

(1) External Power Supply OPCIONAL



ATTENTION

- *It is not possible to recharge the internal batteries of the equipment through the external DC power supply.*
- *The sole purpose of this entry is to allow the equipment to be powered temporarily by a source of compatible external power when there are no other alternatives.*
- *In ventilation before disconnecting an external power, make sure that there is enough load on internal batteries or connect the device to the external power grid.*

11.4.2 Connectors

Table 11 - Connectors

Item	Specification
External Power Network (rede)	Connector 3 (tree) plugs, as ABNT NBR 14136:2012 Central pin ground
External Power Supply	Connector housing 3.96mm – 4 pins 180° female
Distal flow sensor	Connector Redel – 6 pin female receptacles

External Sensors ⁽¹⁾ : capnograph or oximer	Connector series 2001 - step 2 mm 5-way with lock - Female
Connectivity: connection with computers for rescue and data printing (tend and events)	RS-232 connector (EIA RS-232C) Type DB9 female
Updating software without having to open the device	

(1) External Sensors OPTIONAL

11.5 Pneumatic Specifications

11.5.1 Pneumatic Chart

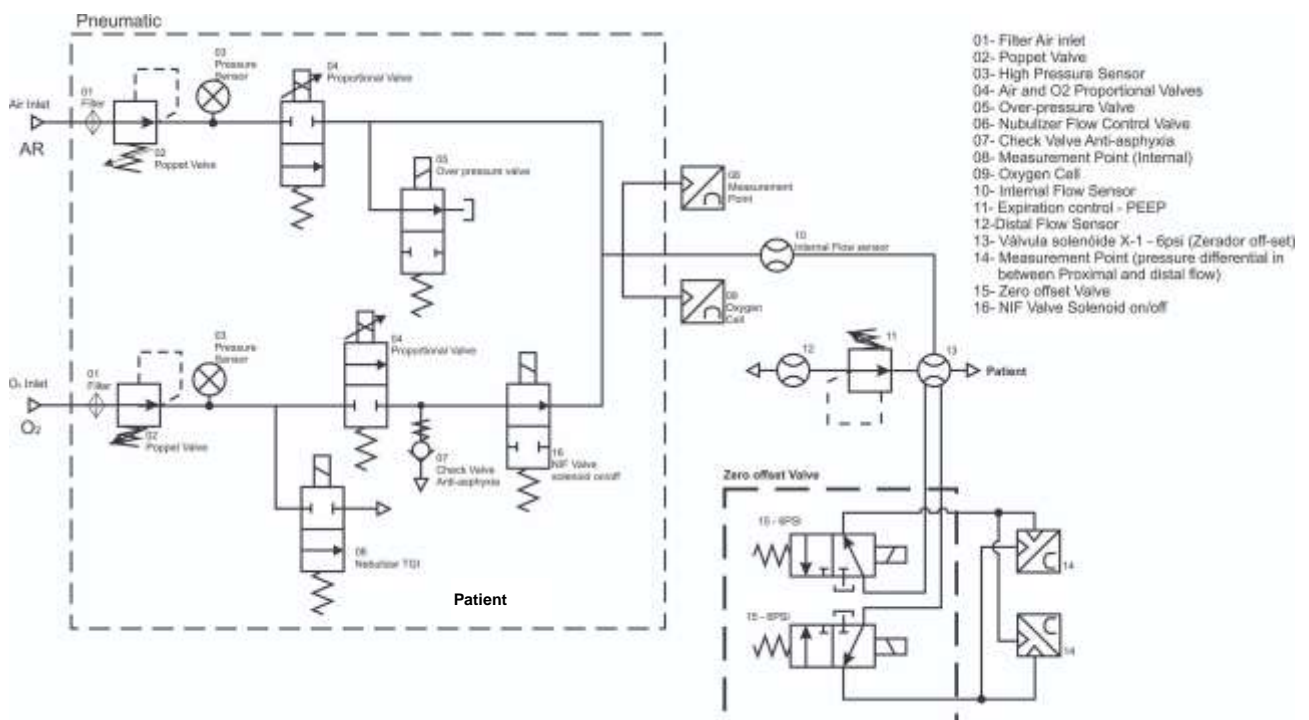

Figure 7 – Pneumatic chart – FlexiMag Plus

11.5.2 Gas inlet connections

Table 12 – Gas inlet connections

Item	Specification
Connections	As ABNT NBR 11906:2011
Hoses and extensions	As ISO 5359:2014
Compressed air inlet	200 to 600 kPa (29 to 87 psi)
O ₂ inlet	200 to 600 kPa (29 to 87 psi)
Humidifier	As ISO 8185:2007
Pulse Oximeter	As ISO 9918:1993 and ISO 9919:2005
Oxygen monitor and alarms conditions	As ISO 7767:1988

ATTENTION

- *Inlet pressures above the specified limit may damage the equipment.*
- *For lower inlet pressures than 250 kPa, the maximum flow is 120 L/min.*

Observations

- *All materials that make up the product are compatible with oxygen gas, ambient air and medical air.*
- *If the network pressure exceeds the maximum inlet pressure specified, the relief valve will open and there will be an audible alarm.*

11.6 Internal Flow Transducer Specifications

Table 13 – Internal Flow Transducer – General Specifications

General Specifications	
<p>The internal flow transducer contains two sensors, a flow sensor and the other to measure the temperature.</p> <p>Each sensor has a nonlinear output voltage independent. To determine the mass flow of gas passing through the transducer, the output voltage of each sensor is measured.</p> <p>A microprocessor processes the results and calculates the flow using a specific algorithm.</p> <p>The circuit measures the flow is generally known as a thermal sensor or hot wire anemometer.</p> <p>This flow transducer uses a heated wire sensor and maintained at a temperature of 150 ° C.</p> <p>The gas velocity through the sensor determines the heat transfer rate between the gas and sensor.</p> <p>This heat transfer rate is translated into a voltage required to maintain the temperature at 150 ° C.</p> <p>Therefore, this voltage is a function of mass flow of gas through the sensor.</p> <p>The heat transfer rate is also influenced by gas temperature.</p> <p>A thermistor circuit is used to measure the gas temperature and a correction is made also through specific algorithm.</p>	
Reading Range	Air: 0 to 300 SLPM O ₂ : 0 to 300 SLPM
Specified Tolerance	Air: 2.0% or 0.05 SLPM (Whichever is greater) O ₂ : 2.0% or 0.05 SLPM (Whichever is greater)
Resistance	< 2.5mbar
Gas temperature range	5 to 46°C
Humidity Range	Dry gas (< 10% UR)
Operating Pressure	Atmospheric Pressure
Power Supply	5V ±10% sensor and 2.7V – 5.5V Eeprom
Answering time	< 2.5ms
Rupture Pressure	Rate above 100 psi
Weight	21g

11.7 Distal Flow Sensor Specifications

Table 14 – Flow sensor distal – General Specifications

General Specifications	
Operating Principle	thermal sensor or hot wire anemometer, thermistor.
Reading Range	0 to 160 SLPM
Tolerance	$\pm 8\%$
Resistance	< 2.5mbar
Pressure Range	$\pm 100\text{mbar}$
Operating Temperature	From 15 to 40°C
Storage Temperature	From -20 to 40°C
Useful Life	While its calibration is successful
Material	MABS
Disinfection	Ethanol Solution 70%

11.8 Proximal Flow Sensor Specifications (Optional)

Table 15 – Proximal Flow Sensor – General Specifications ADULT

General Specifications	
Operation principle	Pressure Differential
Reading Range	0 to 160 SLPM
Tolerance	$\pm 10\%$
Operation Temperature	5 to 50°C
Operation Pressure	700 to 1200 mbar
Storage Temperature	-5 to 60°C
Storage Pressure	500 to 1250 mbar
Humidity Storage	0 to 99%
Material	PSU
Disinfection and sterilization	Disinfection with germicidal solution or steam sterilization

Steam sterilization Cycles	Maximum 50 cycles
----------------------------	-------------------

11.9 Mask for Non-Invasive Ventilation

Specification	
Adult/ Pediatric connection	22 mm
Neonatal connection	15 mm



WARNING

- *Use MASKS specified by MAGNAMED.*
- *Use the appropriate mask for each patient type in order to avoid excessive leakage.*

11.10 Breathing Circuit

Specification	
Adult/ Pediatric connection	22 mm
Neonatal connection	15 mm
Resistance	$\leq 0.3 \text{ mbar/L}\cdot\text{s}^{-1}$

11.11 Ventilation modes specifications

11.11.1 VCV

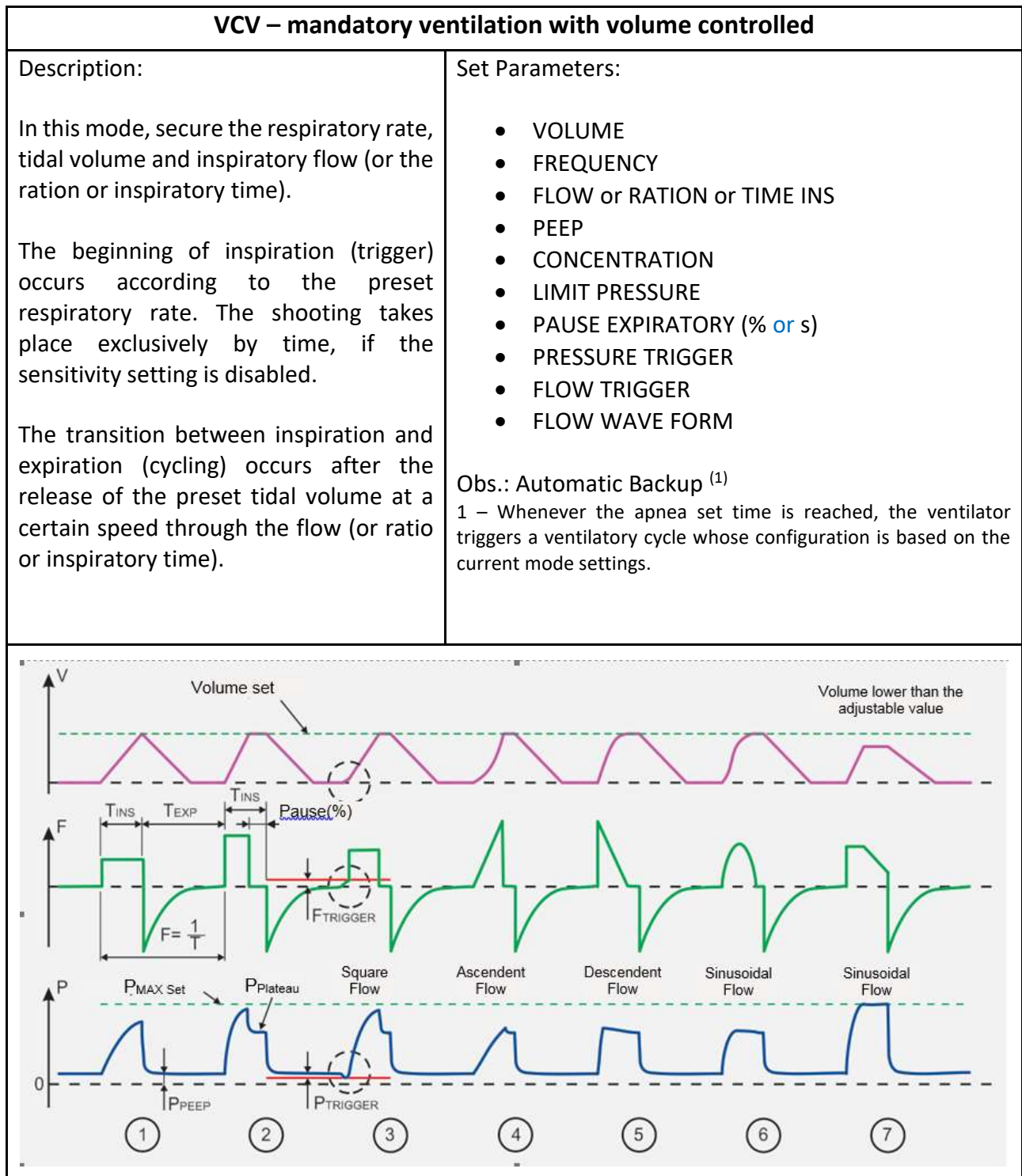

As soon as all ventilation parameters are received by the ventilator, it calculates the T_{INS} , T_{EXP} , T_{PAUSE} and Ratio I:E, by function of the set Flow, Pause, Waveform, and Rate, thus obtaining all the control times to the ventilation.

1. Ventilation without Inspiratory Pause, after T_{INS} the ventilator cycles for expiration. The inspiratory pressure reached is a consequence of the delivered volume, resistance and compliance of the patient's respiratory circuit.
2. Ventilation with Inspiratory Pause, after the adjusted volume is delivered the ventilator maintains interrupted expiration until T_{INS} is completed. Afterwards, the ventilator cycles for expiration. The characteristic is the pressure plateau formation (the gap between the peak and the plateau depends from the airways resistance).
3. If the pressure or flow trigger is activated, the ventilator seeks to synchronize at the beginning of the next inspiration with the patient's effort, according to the established levels. The information related to what type of trigger activated the inspiratory cycle is informed in the status and messages area. The detection of the patient's inspiratory effort in order to synchronize occurs at any moment during the expiratory time.

Observation

- *If the patient makes inspiratory efforts and triggers are suitably set, the ventilatory mode becomes assisted-controlled. In this situation, the monitored breathing frequency can be significantly higher than the set one.*

4. Waveform Flow ASCENDING (or accelerated).
5. Waveform Flow DECENDING (or decelerated).
6. Waveform Flow SINUSOIDAL.
7. Representation of Limited Pressure. In this situation, the ventilator limits the pressure within the adjusted value and, as a consequence of such factors as the patient's lung compliance and imposed pressure limit, the adjusted volume IS NOT DELIVERED and this condition is informed on the screen alarm area (message LIMITED PRESSURE).

WARNING

- ***By reaching the pressure limit defined on the Maximum Pressure adjustment (LIMITED PRESSURE alarm), the Adjusted Volume IS NOT DELIVERED.***
- ***Default values are only an initial reference. Readjust the ventilation parameters according to the patient's needs.***

11.11.2 PCV

PCV – Pressure Controlled Ventilation	
<p>Description:</p> <p>In this ventilation mode, secure the respiratory rate, inspiratory time and inspiratory pressure limit. The trigger, if the sensitivity setting is disabled, is determined exclusively according to the respiratory rate and cycling happens according to the inspiratory time.</p> <p>The current volume depends on the preset inspiratory pressure, the impedance conditions of the respiratory system and inspiratory time selected by the operator.</p>	<p>Set parameters:</p> <ul style="list-style-type: none"> • PRESSURE INSPIRATORY • FREQUENCY • TIME INSPIRATORY • PEEP • CONCENTRATION • ASCENT TIME (RISE TIME) • TRIGGER PRESSURE • TRIGGER FLOW • FLOW (- NEONATAL) <p>Note: automatic Backup⁽¹⁾ 1 – Whenever the apnea set time is reached, the ventilator triggers a ventilatory cycle whose configuration is based on the current mode settings.</p>

As soon as all of these ventilation parameters are adjusted on the ventilator, the same calculates T_{INS} , T_{EXP} according to Frequency and Ratio I:E; therefore, obtaining all ventilation control times.

1. Ventilation by Controlled Pressure - The ventilator seeks to reach the set pressure at the shortest time possible, which is performed by controlling the inspiratory flow.
2. The Volume delivered to the patient is a consequence of resistance and compliance from ventilator respiratory circuit and patient breathing system. The ventilator remains on the adjusted inspiratory

pressure level during T_{INS} after which it cycles to expiration, maintaining the adjusted PEEP pressure.

3. If the pressure or flow trigger is activated, the ventilator seeks to synchronize at the beginning of the next inspiration with the patient's effort, according to the established levels. The information of what type of trigger activated the inspiratory cycle is informed on the screen's messages and status area. The detection of the patient's inspiratory effort in order to synchronize occurs at any moment during the expiratory time.

Observation

- *If the patient makes inspiratory efforts and triggers are suitably set, the ventilatory mode becomes assisted-controlled. In this situation, the monitored breathing frequency can be significantly higher than the set one.*

-
4. The rise time can be adjusted by T_{RISE} (RISE TIME), the initial peak flow. Generally, it is less than $T_{RISE} = 0$ (depending on the respiratory circuit resistance and compliance).

WARNING

- ***Default values are only an initial reference.***
- ***Readjust the ventilation parameters according to the patient's needs.***

11.11.3 PLV

PLV – Pressure Limited Ventilation

Description:

In this ventilation mode of continuous flow, secure the respiratory rate, inspiratory time and inspiratory pressure limit.

The trigger, if the sensitivity setting is disabled, is determined exclusively according to the respiratory rate, but the cycling happens according to the inspiratory time.

The current volume becomes dependent on the preset inspiratory pressure, the impedance conditions of the respiratory system and inspiratory time selected by the operator.

Normally to observe the flow curve, we see a peak flow will decrease as the time passes.

Set parameters:

- PRESSURE INSPIRATORY
- FREQUENCY
- TIME INSPIRATORY
- PEEP
- CONCENTRATION
- FLOW (\dot{V})
- TRIGGER PRESSURE
- TRIGGER FLOW

Volume Guaranteed (VG)

If GUARANTEED VOLUME is enabled, you can set a tidal volume value to be delivered by the ventilator.

Note: automatic Backup⁽¹⁾

1 – Whenever the apnea time is reached, the ventilator triggers a ventilatory cycle whose configuration is based on the current mode settings.

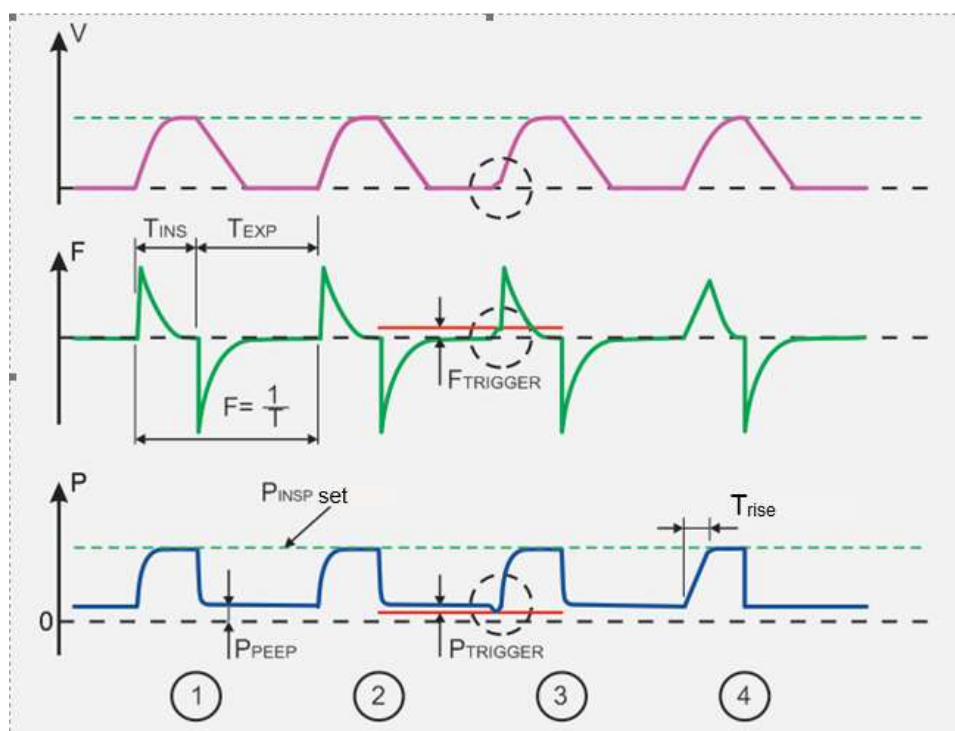

As soon as all ventilation parameters are adjusted on the ventilator, the same calculates T_{EXP} according to the Frequency and T_{INS} ; thus, obtaining all ventilation control times.

1. Pressure Limited Ventilation - The ventilator seeks to reach the set inspiratory pressure, which is performed through exhalation valve occlusion. It is important to notice that the pressure's rise time depends from the continuous adjusted flow.
2. The Volume delivered to the patient is a consequence of resistance and compliance from ventilator respiratory circuit and patient breathing system. The ventilator remains on the adjusted inspiratory pressure level during T_{INS} after which it cycles to expiration, maintaining the adjusted PEEP pressure.
3. If the pressure or flow trigger is activated, the ventilator seeks to synchronize at the beginning of the next inspiration with the patient's effort, according to the established levels. The information regarding what type of trigger activated the inspiratory cycle is informed on the screen's messages and status area. The detection of the patient's inspiratory effort in order to synchronize occurs at any moment during the expiratory time.



WARNING

- *Default values are only an initial reference.*
- *Readjust the ventilation parameters according to the patient's needs.*



Observation

- *If the patient makes inspiratory efforts and triggers are suitably set, the ventilatory mode becomes assisted-controlled. In this situation, the monitored breathing frequency can be significantly higher than the set one.*

11.11.4 PRVC

PRVC – Volume controlled regulated pressure	
<p>Description:</p> <p>Time cycled ventilation mode and limited pressure using tidal volume as feedback to continuously adjust the pressure threshold.</p> <p>The first three breaths are in volume control mode, allowing the ventilator to calculate respiratory mechanics. In the next cycle ventilation is distributed with pressure limit and cycled time to reach 60% of the set volume.</p> <p>At each cycle the ventilator adjusts the pressure limit (5 cmH₂O upward) as the tidal volume delivered in the previous cycle, until reaching the tidal volume specified by the operator.</p> <p>The maximum pressure limit is 5 cm H₂O below the pressure limit indicated by the operator.</p>	<p>Set parameters:</p> <ul style="list-style-type: none"> • VOLUME • PRESSURE LIMIT • FREQUENCY • TIME INSPIRATORY • PEEP • CONCENTRATION • ASCENT TIME (RISE TIME) • TRIGGER PRESSURE • TRIGGER FLOW <p>Note: automatic Backup⁽¹⁾ 1 – Whenever the apnea set time is reached, the ventilator triggers a ventilatory cycle whose configuration is based on the current mode settings.</p>
<p>As soon as all ventilation parameters are adjusted on the ventilator, the same calculates T_{EXP} according to the Rate and T_{INS}; thus, obtaining all ventilation control times.</p>	

1, 2, 3. Lung compliance assessment phase. After obtaining the compliance value, the ventilator automatically adjusts a pressure value in order to reach 60% of the adjusted volume. Then, the ventilator automatically adjusts the pressure at each three PCV cycles.

4,5. Beginning of pressure automatic control in order to reach the defined volume.

6. If pressure and flow triggers are active, the ventilator then seeks to synchronize the beginning of the next inspiration to the patient's effort, according to the configured trigger. The patient's effort "window" detection to synchronize begins on the last fourth period of the controlled ventilation.

7. Reached Volume.



WARNING

- ***By reaching the pressure limit defined on the Maximum Pressure adjustment (LIMITED PRESSURE alarm), the Adjusted Volume IS NOT DELIVERED.***
- ***Default values are only an initial reference.***
- ***Readjust the ventilation parameters according to the patient's needs.***



Observation

- *If the patient makes inspiratory efforts and triggers are suitably set, the ventilatory mode becomes assisted-controlled. In this situation, the monitored breathing rate can be significantly higher than the set one.*
- *Automatic pressure control occurs with PEEP+5cmH₂O e PLimit*

11.11.5 V-SIMV

V-SIMV – Volume Synchronized Intermittent Mandatory Ventilation	
<p>Description:</p> <p>In V-SIMV, secure respiratory rate, tidal volume and the inspiratory flow or the ratio or inspiratory time, beyond the sensitivity criteria for the occurrence of ventilator trigger by the patient.</p> <p>This mode allows the ventilator to apply the mandatory cycles predetermined in sync with the inspiratory effort of the patient.</p> <p>The mandatory cycles occur in the predetermined time window (according to the set respiratory rate), but synchronized with the patient trigger.</p> <p>If apnea, the next cycle will be triggered by time until they return the inspiratory incursions patient</p> <p>To obtain this IMV mode, just off the support pressure support setting the zero pressure ($\Delta PS = 0$) or the flow and pressure sensitivities equal to zero.</p>	<p>Set parameters:</p> <ul style="list-style-type: none"> • VOLUME • RATE • FLOW or RATIO or TIME INS • PEEP • CONCENTRATION • FLOW WAVEFORM • PAUSE (%) • TRIGGER PRESSURE • TRIGGER FLOW • ΔPS (Pressure Support - PEEP) • RISE TIME • FLOW CYCLING (% FLOW) • LIMIT PRESSURE <p>Note: automatic Backup⁽¹⁾ 1 – Whenever the apnea set time is reached, the ventilator triggers a ventilatory cycle whose configuration is based on the current mode settings.</p>

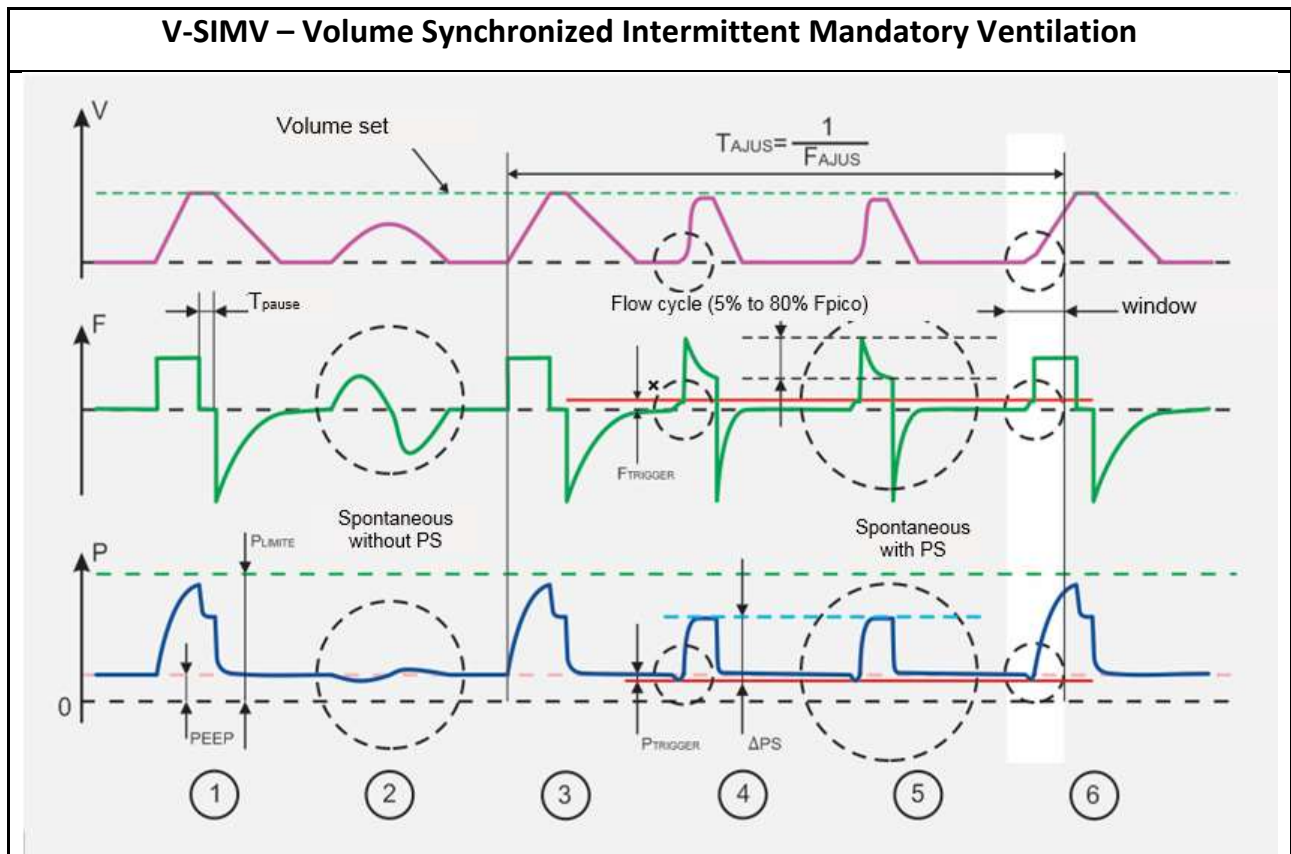

As soon as all ventilation parameters are set in the ventilator, it calculates the T_{INSP} and T_{EXP} by function of Flow, Pause, Waveform, and Rate, thus obtaining all the ventilation control times.

1. Represents a VCV cycle (controlled volume) with inspiratory pause;
2. Represents a spontaneous breathing cycle by the patient WITHOUT SUPPORTING PRESSURE;
3. Represents a VCV cycle (controlled volume) after the SIMV Period;
4. Represents a spontaneous breathing cycle by the patient WITH SUPPORTING PRESSURE, whose cycling occurs by flow, when this reaches a value between 25% and 75% of the read peak value.
5. The peak's flow percentage in which the cycling from inspiratory phase to expiratory phase occur is programmable. The rise time (T_{RISE}) also applies to support pressure (refer to PCV).
6. If the patient realizes inspiratory effort, a window will appear at the end of the SIMV (T_{SIMV}) period in order to synchronize the controlled ventilation cycle, which is "opened" from $0.75 \times (T_{\text{SIMV}})$. In other words, a synchronism window opens during the last fourth of the SIMV period during the mandatory ventilation cycle. The information regarding what type of trigger activated the inspiratory cycle is informed on the screen's messages and status area.



WARNING

- *The support pressure adjusted (ΔPS) is a value above PEEP. Therefore, the support inspiratory pressure will be the sum of PEEP and ΔPS .*
 - *Default values are only an initial reference.*
 - *Readjust the ventilation parameters according to the patient's needs.*
-



Observation

- *The monitored respiratory frequency may be greater than the adjusted respiratory rate, since the patient may breathe spontaneously during mandatory ventilation cycles;*
-

11.11.6 P-SIMV

P-SIMV – Pressure Synchronized Intermittent Mandatory Ventilation	
<p>Description:</p> <p>P-SIMV, secure the respiratory rate, inspiratory pressure and inspiratory time, beyond the sensitivity criteria for the occurrence of ventilator shooting by the patient.</p> <p>This mode allows the ventilator to apply the mandatory cycles predetermined in sync with the inspiratory effort of the patient.</p> <p>The mandatory cycles occur in the predetermined time window (according to the set respiratory rate), but synchronized with the patient trigger.</p> <p>If there is an apnea, the next cycle will be triggered by time until they return the inspiratory incursions patient</p> <p>To obtain this IMV mode, just off the support pressure support setting the zero pressure ($\Delta PS = 0$) or the flow and pressure sensitivities equal to zero.</p>	<p>Set parameters:</p> <ul style="list-style-type: none"> • PRESSURE INSPIRATORY • FREQUENCY • TIME INSPIRATORY • PEEP • CONCENTRATION • RISE TIME • ΔPS (Pressure Support - PEEP) • FLOW CYCLING (% FLOW) • TRIGGER PRESSURE • TRIGGER FLOW • FLOW (\dot{V} - NEONATAL) <p>Note: automatic Backup⁽¹⁾ 1 – Whenever the apnea set time is reached, the ventilator triggers a ventilatory cycle whose configuration is based on the current mode settings.</p>

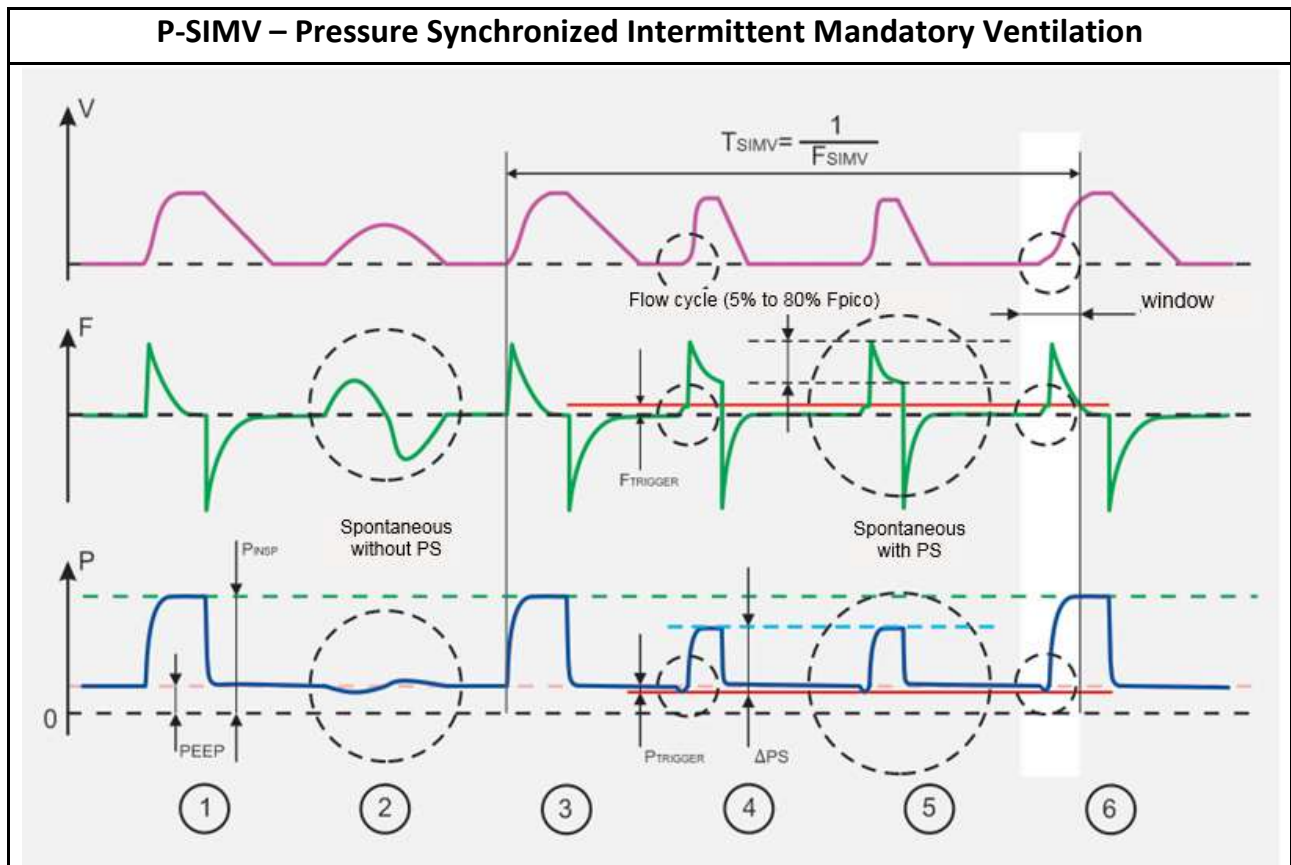

As soon as all ventilation parameters are adjusted on the ventilator, this calculates the T_{EXP} according to T_{INS} and Frequency; thus, obtaining all ventilation controlled time.

1. Represents a PCV (pressure controlled) cycle during T_{INS} ;
2. Represents a spontaneous breathing cycle by the patient WITHOUT SUPPORTING PRESSURE;
3. Represents a PCV cycle (controlled pressure) after the SIMV Period;
4. Represents a spontaneous breathing cycle by the patient WITH SUPPORTING PRESSURE, whose cycling occurs by flow, when this reaches a value between 25% and 75% of the read peak value.
5. The peak's flow percentage in which the cycling from inspiratory phase to expiratory phase occur is programmable. The rise time (T_{RISE}) also applies to support pressure (refer to PCV).
6. If the patient realizes inspiratory effort, a window will appear at the end of the SIMV (T_{SIMV}) period in order to synchronize the controlled ventilation cycle, which is "opened" from $0.75 \times (T_{SIMV})$. In other words, a synchronism window opens during the last fourth of the SIMV period during the mandatory ventilation cycle. The information regarding what type of trigger activated the inspiratory cycle is informed on the screen's messages and status area.



WARNING

- *The set supporting pressure (ΔPS) is a value above PEEP. Therefore, the supporting inspiratory pressure will be the sum of PEEP and ΔPS .*
 - *Default values are only an initial reference.*
 - *Readjust the ventilation parameters according to the patient's needs.*
-



Observation

- *The monitored respiratory frequency may be greater than the adjusted respiratory frequency, since the patient may breathe spontaneously during mandatory ventilation cycles;*
-

11.11.7 CPAP/PS

CPAP/PS – Continuous Positive Airway Pressure/ Pressure Support			
<p>Description:</p> <p>In CPAP / PS, the ventilator allows the patient to breathe spontaneously, but provides a continuous pressurization both in inspiration and in expiration, and assist ventilation during inspiration by maintaining a support pressure until the inspiratory flow of the patient reduce to a critical level (adjustable) peak of inspiratory flow.</p> <p>This allows the patient to control the respiratory frequency and inspiratory time and thus the volume of air inspired.</p> <p>If the value of the pressure support (ΔPS) is set to 0 (zero) and cycle the trigger are both off, ventilation will be characterized with pure CPAP mode, which is a spontaneous ventilation mode is not assisted by the ventilator.</p> <p>Tidal volume depends on the patient's inspiratory effort and the conditions of the respiratory function of the lung and the chest wall.</p>	<p>Set parameters:</p> <ul style="list-style-type: none"> • PEEP / CPAP • CONCENTRATION • ΔPS (Pressure Support - PEEP) • FLOW CYCLING (% FLOW) • RISE TIME • TRIGGER PRESSURE • TRIGGER FLOW • FLOW (NEONATAL) • BACKUP <table style="width: 100%; border: none;"> <tr> <td style="vertical-align: top;"> <ul style="list-style-type: none"> ○ Backup VCV <ul style="list-style-type: none"> ▪ VOLUME ▪ RATE ▪ FLOW ▪ LIMIT PRESSURE ○ Backup PCV <ul style="list-style-type: none"> ▪ PRESSURE INSP ▪ RATE ▪ TIME INSP ▪ RISE TIME </td> <td style="vertical-align: top;"> <ul style="list-style-type: none"> ○ Backup PLV-NEONATAL <ul style="list-style-type: none"> ▪ PRESSURE INSP ▪ RATE ▪ TIME INSP ○ Backup Auto⁽¹⁾ </td> </tr> </table> <p>1 – Whenever the apnea set time is reached, the ventilator triggers a ventilatory cycle whose configuration is based on the current mode settings.</p>	<ul style="list-style-type: none"> ○ Backup VCV <ul style="list-style-type: none"> ▪ VOLUME ▪ RATE ▪ FLOW ▪ LIMIT PRESSURE ○ Backup PCV <ul style="list-style-type: none"> ▪ PRESSURE INSP ▪ RATE ▪ TIME INSP ▪ RISE TIME 	<ul style="list-style-type: none"> ○ Backup PLV-NEONATAL <ul style="list-style-type: none"> ▪ PRESSURE INSP ▪ RATE ▪ TIME INSP ○ Backup Auto⁽¹⁾
<ul style="list-style-type: none"> ○ Backup VCV <ul style="list-style-type: none"> ▪ VOLUME ▪ RATE ▪ FLOW ▪ LIMIT PRESSURE ○ Backup PCV <ul style="list-style-type: none"> ▪ PRESSURE INSP ▪ RATE ▪ TIME INSP ▪ RISE TIME 	<ul style="list-style-type: none"> ○ Backup PLV-NEONATAL <ul style="list-style-type: none"> ▪ PRESSURE INSP ▪ RATE ▪ TIME INSP ○ Backup Auto⁽¹⁾ 		

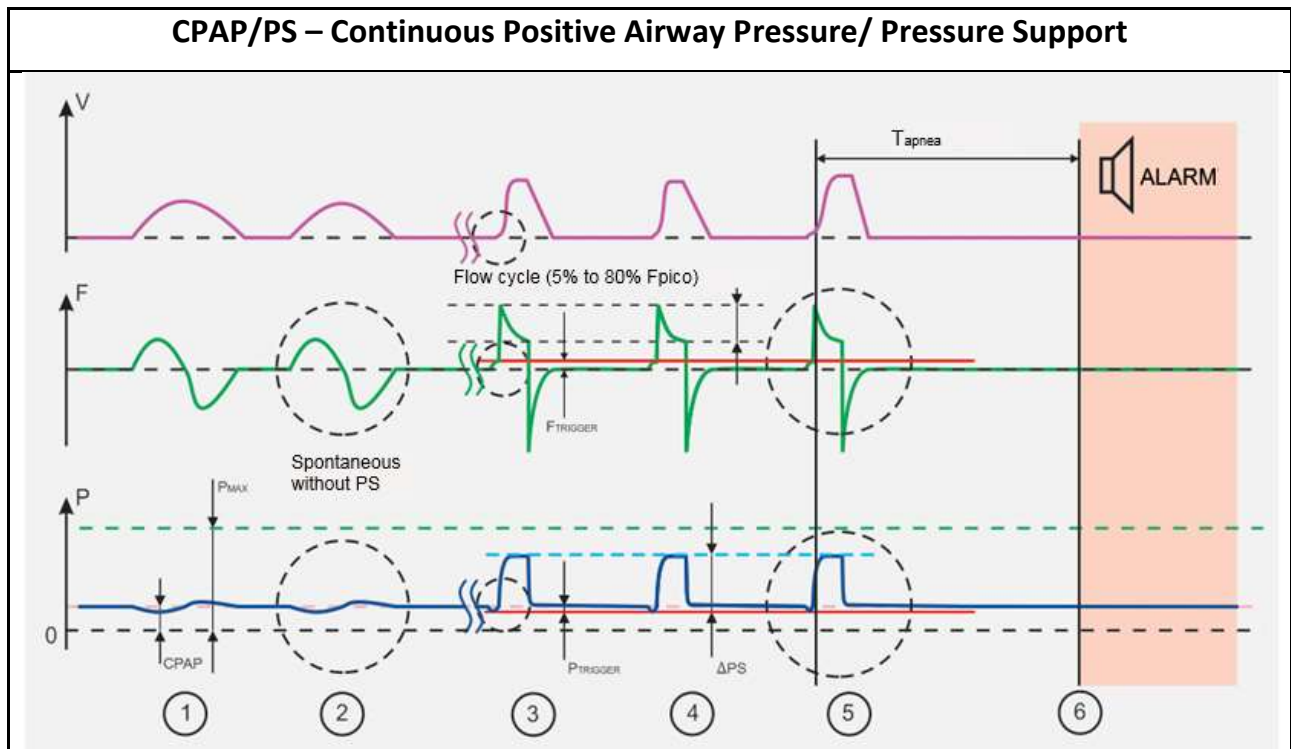

1 and 2 Represents spontaneous cycles with pressure support on ZERO.

3, 4, and 5 - Represents the patient's spontaneous respiration cycles with a pressure support different from zero. The pressure support's $T_{RISE\ TIME}$ can be adjusted in order to mitigate the initial flow. The cycling flow may be adjusted to a value between a peak flow of 25% to 75%.

6. In the event the patient enters into apnea, the ventilator will present this condition through an alarm on the screen's message and alarms area after T_{APNEA} and will initiate selected back-up ventilation, according to the programmed configurations and parameters.



WARNING

- **The set supporting pressure (ΔPS) is a value above PEEP. Therefore, the supporting inspiratory pressure will be the sum of PEEP and ΔPS .**
- **Default values are only an initial reference.**
- **Readjust the ventilation parameters according to the patient's needs**

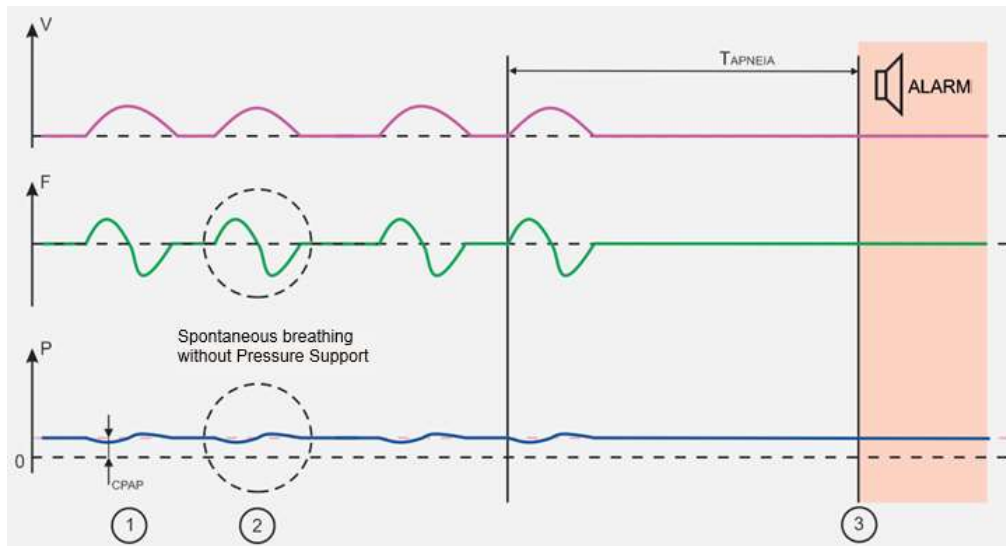

1 and 2 – Represents spontaneous cycles.

3. If the patient does not breathe after the time for apnea, the ventilator presents that condition on the display and with an audible alarm.

11.11.8 DualPAP

DualPAP – Dual Continuous Positive Airway Pressure			
<p>Description:</p> <p>In DualPAP, the ventilator works at two pressure levels adjusted by the operator, Pr Superior and Pr Inferior.</p> <p>The change to the lower level of pressure occurs at the end of Superior T (given time to the higher level of pressure). Similarly, the restoration of the higher pressure level so happens that is exhausted Low T (time for the level of the lower pressure).</p> <p>Consequently, the respiratory rate and I:E ratio are directly related to this alternation between levels.</p> <p>DualPAP allows spontaneous cycles in both pressure levels and includes synchronization of possibility with the inspiratory effort of the patient.</p> <p>When there are no spontaneous breathing, DualPAP is similar to pressure control mode, differing from the latter because the adjusting time (T Upper and Lower T), rather than the respiratory rate.</p>	<p>Set parameters:</p> <ul style="list-style-type: none"> • PR. SUPERIOR • T. SUPERIOR • PR. INFERIOR • T. INFERIOR • CONCENTRATION • ΔPS (Pressure Support – PEEP) • LIMIT PRESSURE • CYCLING FLOW (% FLOW) • TRIGGER PRESSURE • TRIGGER FLOW • RISE TIME • FLOW (\dot{V} - NEONATAL); • BACKUP <table style="width: 100%; border: none;"> <tr> <td style="vertical-align: top;"> <ul style="list-style-type: none"> ○ Backup VCV <ul style="list-style-type: none"> ▪ VOLUME ▪ RATE ▪ FLOW ▪ LIMIT PRESSURE ○ Backup PCV <ul style="list-style-type: none"> ▪ PRESSURE INSP ▪ RATE ▪ TIME INSP ▪ RISE TIME </td> <td style="vertical-align: top;"> <ul style="list-style-type: none"> ○ Backup PLV-NEONATAL <ul style="list-style-type: none"> ▪ PRESSURE INSP ▪ RATE ▪ TIME INSP ○ Backup Auto⁽¹⁾ 1 – Whenever the apnea set time is reached, the ventilator triggers a ventilatory cycle whose configuration is based on the current mode settings. </td> </tr> </table>	<ul style="list-style-type: none"> ○ Backup VCV <ul style="list-style-type: none"> ▪ VOLUME ▪ RATE ▪ FLOW ▪ LIMIT PRESSURE ○ Backup PCV <ul style="list-style-type: none"> ▪ PRESSURE INSP ▪ RATE ▪ TIME INSP ▪ RISE TIME 	<ul style="list-style-type: none"> ○ Backup PLV-NEONATAL <ul style="list-style-type: none"> ▪ PRESSURE INSP ▪ RATE ▪ TIME INSP ○ Backup Auto⁽¹⁾ 1 – Whenever the apnea set time is reached, the ventilator triggers a ventilatory cycle whose configuration is based on the current mode settings.
<ul style="list-style-type: none"> ○ Backup VCV <ul style="list-style-type: none"> ▪ VOLUME ▪ RATE ▪ FLOW ▪ LIMIT PRESSURE ○ Backup PCV <ul style="list-style-type: none"> ▪ PRESSURE INSP ▪ RATE ▪ TIME INSP ▪ RISE TIME 	<ul style="list-style-type: none"> ○ Backup PLV-NEONATAL <ul style="list-style-type: none"> ▪ PRESSURE INSP ▪ RATE ▪ TIME INSP ○ Backup Auto⁽¹⁾ 1 – Whenever the apnea set time is reached, the ventilator triggers a ventilatory cycle whose configuration is based on the current mode settings. 		

DualPAP – Dual Continuous Positive Airway Pressure

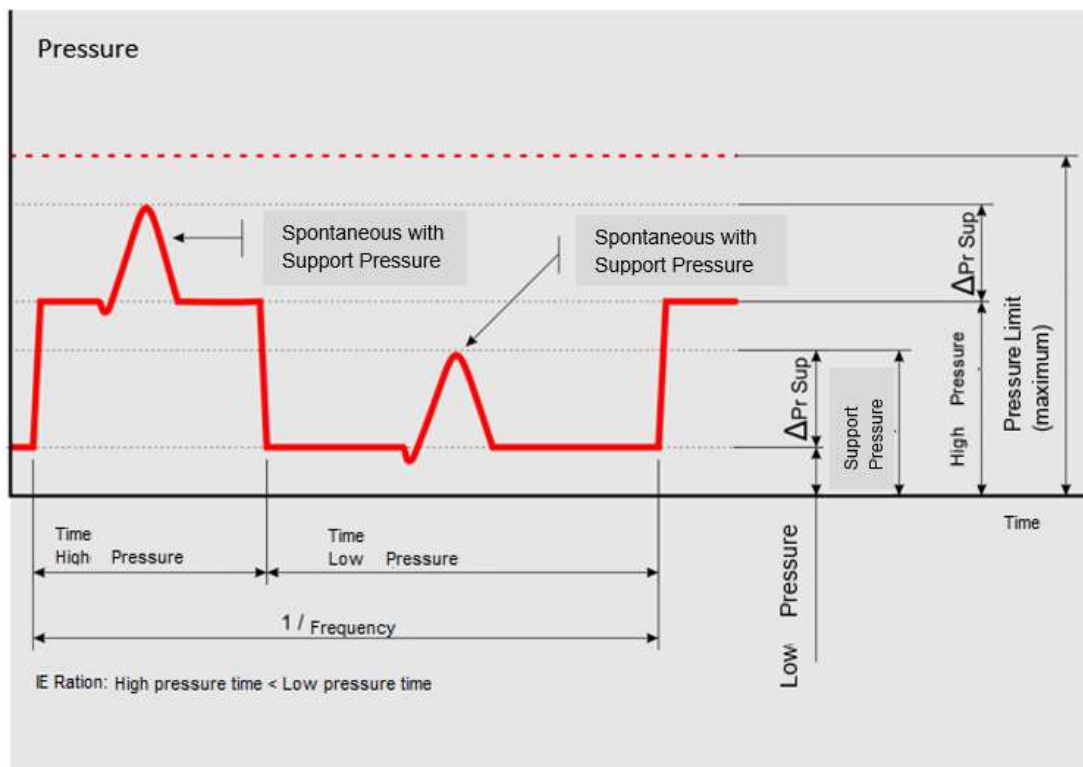
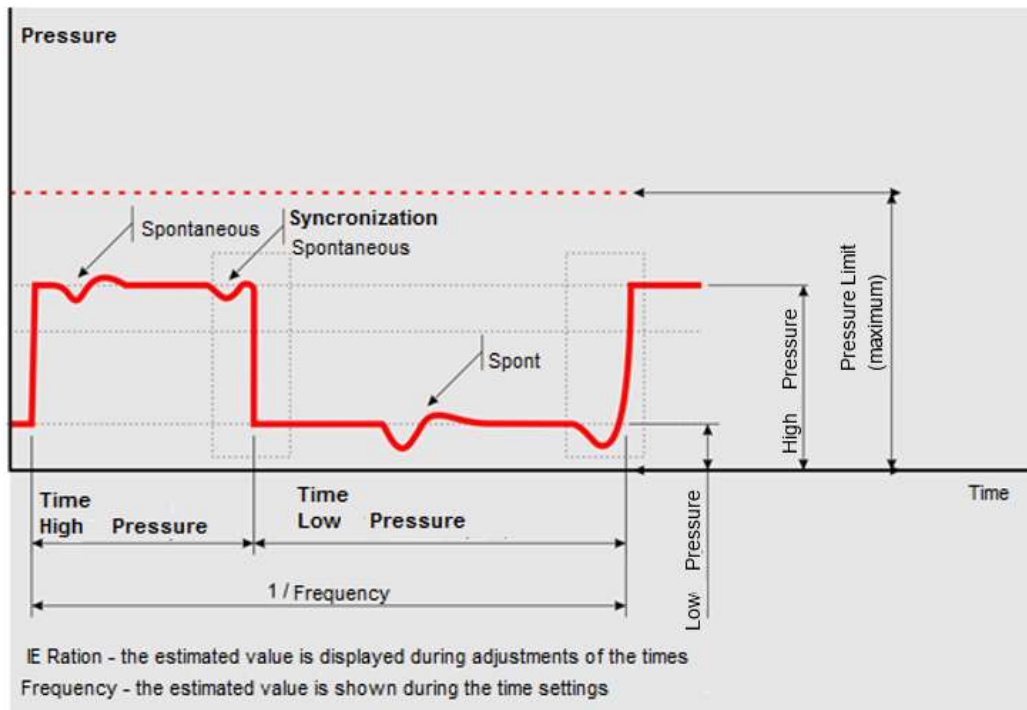



WARNING

- *The supporting pressure (ΔPS) is a value above the Upper Pressure or Lower Pressure. Therefore, the maximum supporting pressure will be the sum of this reference pressure to ΔPS .*
- *Default values are only an initial reference.*
- *Readjust the ventilation parameters according to the patient's needs.*
- *In the absence of spontaneous cycles when in DualPAP, adjust the superior and inferior pressure so that the minute volume delivered to the patient is sufficient.*



Observation

- *Changes in pressure levels are synchronized.*

11.11.9 APRV

APRV – Airway pressure release ventilation			
<p>Description:</p> <p>In APRV, the ventilator works at two pressure levels adjusted by the operator, Pr Superior and Pr Inferior.</p> <p>The transitional relief to the lower level of pressure occurs at the end of Superior T (time given to the higher level of pressure). Similarly, the restoration of the higher pressure level happens once you are exhausted T Lower (pressure relief time).</p> <p>Consequently, the respiratory rate and I:E ratio resulting are directly related to this alternation between levels.</p> <p>APRV is characterized by the inversion of the I:E ratio, where the lower pressure level time is usually less than the higher pressure level, functioning only as a temporary relief.</p> <p>No spontaneous breathing APRV is similar to pressure control mode, differing from the latter because the adjusting stroke (upper and lower), rather than the respiratory rate.</p>	<p>Set parameters:</p> <ul style="list-style-type: none"> • PR. SUPERIOR • T. SUPERIOR • PR. INFERIOR • T. INFERIOR • CONCENTRATION • ΔPS (Pressure Support – PEEP) • PRESSURE LIMIT; • CYCLING FLOW (% FLOW); • TRIGGER PRESSURE • FLOW PRESSURE • RISE TIME • FLOW (NEONATAL) • BACKUP <table style="width: 100%; border: none;"> <tr> <td style="vertical-align: top;"> <ul style="list-style-type: none"> ○ Backup VCV <ul style="list-style-type: none"> ▪ VOLUME ▪ RATE ▪ FLOW ▪ LIMIT PRESSURE ○ Backup PCV <ul style="list-style-type: none"> ▪ PRESSURE INSP ▪ RATE ▪ TIME INSP ▪ RISE TIME </td> <td style="vertical-align: top;"> <ul style="list-style-type: none"> ○ Backup PLV-NEONATAL <ul style="list-style-type: none"> ▪ PRESSURE INSP ▪ RATE ▪ TIME INSP ○ Backup Auto⁽¹⁾ 1 – Whenever the apnea set time is reached, the ventilator triggers a ventilatory cycle whose configuration is based on the current mode settings. </td> </tr> </table>	<ul style="list-style-type: none"> ○ Backup VCV <ul style="list-style-type: none"> ▪ VOLUME ▪ RATE ▪ FLOW ▪ LIMIT PRESSURE ○ Backup PCV <ul style="list-style-type: none"> ▪ PRESSURE INSP ▪ RATE ▪ TIME INSP ▪ RISE TIME 	<ul style="list-style-type: none"> ○ Backup PLV-NEONATAL <ul style="list-style-type: none"> ▪ PRESSURE INSP ▪ RATE ▪ TIME INSP ○ Backup Auto⁽¹⁾ 1 – Whenever the apnea set time is reached, the ventilator triggers a ventilatory cycle whose configuration is based on the current mode settings.
<ul style="list-style-type: none"> ○ Backup VCV <ul style="list-style-type: none"> ▪ VOLUME ▪ RATE ▪ FLOW ▪ LIMIT PRESSURE ○ Backup PCV <ul style="list-style-type: none"> ▪ PRESSURE INSP ▪ RATE ▪ TIME INSP ▪ RISE TIME 	<ul style="list-style-type: none"> ○ Backup PLV-NEONATAL <ul style="list-style-type: none"> ▪ PRESSURE INSP ▪ RATE ▪ TIME INSP ○ Backup Auto⁽¹⁾ 1 – Whenever the apnea set time is reached, the ventilator triggers a ventilatory cycle whose configuration is based on the current mode settings. 		

APRV – Airway pressure release ventilation

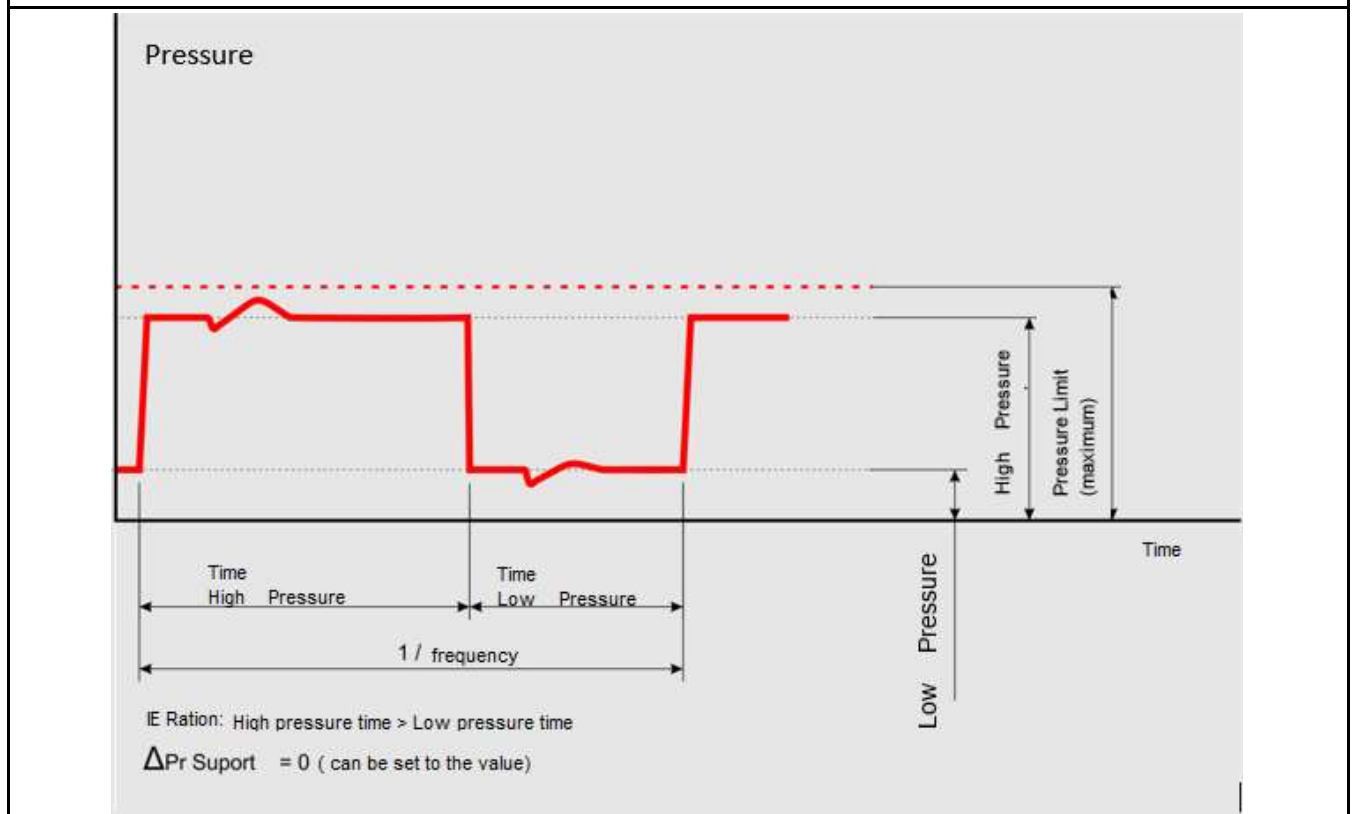

WARNING

- *The supporting pressure (ΔPS) is a value above the Upper Pressure or Lower Pressure. Therefore, the maximum supporting pressure will be the sum of this reference pressure to ΔPS .*
- *Default values are only an initial reference.*
- *Readjust the ventilation parameters according to the patient's needs.*

11.11.10 MMV - Mandatory minute ventilation

MMV – Mandatory minute ventilation	
<p>Description:</p> <p>Initially, the ventilator allows spontaneous testing cycles with supporting pressure of 5 or 10 cmH₂O above the set PEEP.</p> <p>So, the minute volume is measured and approximate compliance is calculated.</p> <p>For each subsequent cycle, the ventilator re-calculates the previous cycle compliance and sets the pressure level to reach the set minute volume in the upcoming cycles.</p> <p>The pressure increase between the cycles is never above 3 cmH₂O and the maximum level reached, is never above the set limit pressure.</p> <p>If this value is reached, without the minute volume's being reached, the alarm will be displayed to limited pressure.</p> <p>On the other hand, if the set apnea time is reached, the backup ventilation will be activated.</p>	<p>Set parameters:</p> <ul style="list-style-type: none"> • MINUTE VOLUME • PEEP • CYCLING FLOW (% FLOW) • TRIGGER PRESSURE • FLOW PRESSURE • CONCENTRATION • RISE TIME • LIMIT PRESSURE • BACKUP <ul style="list-style-type: none"> ○ Backup VCV <ul style="list-style-type: none"> ▪ VOLUME ▪ RATE ▪ FLOW ▪ LIMIT PRESSURE ○ Backup PCV <ul style="list-style-type: none"> ▪ PRESSURE INSP ▪ RATE ▪ TIME INSP ▪ RISE TIME ○ Backup Auto⁽¹⁾ 1 – Whenever the apnea set time is reached, the ventilator triggers a ventilatory cycle whose configuration is based on the current mode settings.

11.11.11 VS

VS – Spontaneous Ventilation with Ensured Volume	
<p>Description:</p> <p>Initially, the ventilator allows spontaneous testing cycles with supporting pressure of 5 or 10 cmH₂O above the set PEEP.</p> <p>So, the delivered volume is measured and the approximate compliance is calculated.</p> <p>For each subsequent cycle, the ventilator re-calculates the previous cycle compliance and sets the pressure level to reach the set volume in the upcoming cycles.</p> <p>The pressure increase between the cycles is never above 3 cmH₂O and the maximum level reached, is never above the set limit pressure.</p> <p>If this value is reached, without the set volume's being reached, the alarm will be displayed to limited pressure.</p> <p>On the other hand, if the set apnea time is reached, the backup ventilation will be activated.</p>	<p>Set parameters:</p> <ul style="list-style-type: none"> ● VOLUME ● PEEP ● CYCLING FLOW (% FLOW) ● TRIGGER PRESSURE ● TRIGGER FLOW ● CONCENTRATION ● RISE TIME ● LIMIT PRESSURE ● BACKUP <div style="display: flex; justify-content: space-between;"> <div style="width: 45%;"> <ul style="list-style-type: none"> ○ Backup PRVC <ul style="list-style-type: none"> ▪ RATE ▪ TIME </div> <div style="width: 45%;"> <ul style="list-style-type: none"> ○ Backup Auto⁽¹⁾ <p>1 – Whenever the apnea set time is reached, the ventilator triggers a ventilatory cycle whose configuration is based on the current mode settings.</p> </div> </div>



WARNING

- ***The apnea time alarm may be turned off. In this condition, BACKUP VENTILATION WILL NEVER BE ACTIVATE.***
- ***If the backup ventilation is turned off, the operator must be sure that this adjustment is really necessary and aware of the clinical implications involved.***

11.12 Adjustable Parameter Specifications

Table 16 – Adjustable Parameters

Parameter	Specification	Resolution	Unit	
Tidal Volume	2,0 to 3000	Neonatal ⁽¹⁾	2,0 to 10,0: 0,1	mL
			10 to 99: 1	
		Pediatric	10 to 100: 5	
			100 to 300: 10	
		Adult	100 to 1000: 10	
			1000 to 3000: 50	
Breathing Rate ⁽²⁾⁽³⁾	0 to 200	Neonatal	0 to 200:1	rpm
		Pediatric	0 to 200:1	
		Adult	0 to 100:1	
Rise Time	0 to 2,0	0.1	s	
Pause	0 to 70	10	%	
	0 to 2,0	0,1	s	
Inspiratory and Limit Pressure	0 to 120	1	cmH ₂ O	
ΔPS	0 to 120	1 cmH ₂ O	cmH ₂ O	
PEEP	0 to 50	1 cmH ₂ O	cmH ₂ O	
Pressure trigger	0,0 to -20	0.00 to -2.0 : - 0,2	cmH ₂ O	
		-0.05 to -20 : - 1		
Flow trigger	0,0 to 30	0.00 to 1.0 : 0,1	L/min	
		1,0 to 30,0 : 0,5		
Cycled-Flow	5 to 80 (max. 3 s)	5	%	
O ₂ Concentration	21 to 100	1	% vol	
Inspiratory Time	0,05 to 30	0.05 to 0,70 : 0,01	s	
		0.70 to 1,00 : 0,05		
		1,0 to 30,0 : 0,1		
Inspiratory Flow's Waveform	Square, Descending or Decelerated, Ascending or Accelerated, Sinusoidal or sinusoid	---	---	
CPAP	0 to 50	1	cmH ₂ O	
High Pressure (APRV/DualPAP)	5 to 90	1	cmH ₂ O	
Low Pressure (APRV/DualPAP)	0 to 45	1	cmH ₂ O	

Parameter	Specification	Resolution	Unit
High Time (APRV/DualPAP)	0,10 to 59,9	0,10 to 0,70: 0,01	s
		0,70 to 1,00: 0,05	
		1,00 to 59,90: 0,10	
Low Time (APRV/DualPAP)	0,20 to 59,9	0,20 to 0,70: 0,01	s
		0,70 to 1,00: 0,05	
		1,00 to 59,90: 0,10	
I:E Ratio	1:599 a 299:1 ⁽³⁾	1:0,1	---
Backup ⁽⁴⁾	OFF;PLV; PCV; VCV and PRVC	---	---
Inspiratory Flow	1 to 180	1	L/min
Height	10 (neonatal) to 250 (adult) ⁽⁸⁾	1	cm
Nebulizer flow - 100% Oxygen ⁽⁵⁾	5 to 8 (not adjustable directly)	---	L/min
Nebulizer time	1 to 50	1	min
TGI Flow – 100% Oxygen ⁽⁵⁾	5 to 8 (not adjustable directly)	---	L/min
Sigh ⁽⁶⁾	1 to 3	1	sigh
Sigh Volume ⁽⁶⁾	10 to 100	10	% Vt
Sigh Frequency ⁽⁶⁾	20 to 100	10	cycles
Tube Compensation	Endotracheal Tracheostomy	---	---
Tube Diameter	2,5 to 12,0	2,5 to 10 : 0,5	mm
		10 to 12 : 1	
% of Tube Compensation	10 to 100	10	%
Minimum Inspiratory Pause ⁽⁷⁾ Minimum Expiratory Pause	0,1 to 30	0,1 to 1 : 0,1	s
		1 to 30 : 1	
Time of mute alarm	OFF, 10 to 120	10	s
Time to lock screen	OFF. 1 to 30	1 to 5 : 1	min
		10 to 30 : 5	
Minute Volume (MMV)	1,0 to 50,0	0,1	L
Flow (PLV)	1 to 40	1	L/min

(1) Volume for neonatal patients only with proximal flow sensor NEONATAL and PLV mode VOLUME GUARANTEED ON.

(2) Respiratory Rate 0 (zero) will only be achieved in spontaneous ways, with sensitivities and apnea time alarm off.

- (3) The minimum and maximum values of rate and I: E ratio, depend on the set ventilation mode.
- (4) Adjustable backup options for spontaneous modes to other modes, backup is automatic.
- (5) The nebulizer flow and TGI may not be activated simultaneously.
- (7) Adjustment sigh available in the VCV and V-SIMV modes.
- (8) Time of pauses when press and immediately release the button.
- (9) The weight of the patient considered by the equipment is the ideal body weight, calculated according the height of the patient.



ATTENTION

- *The adjust volume for neonatal patient is only available when the ventilator is with proximal flow sensor NEONATAL and PLV mode with guaranteed volume activated.*
 - *FlexiMag Plus ventilator attends any patients from preterm to morbidly obese, however, the patient height adjustment used to calculate the ideal weight is limited.*
 - *For patients who exceed this limit, the parameters may be adjusted directly by the operator.*
-

11.13 Monitored Parameter Specifications

Table 17- Monitored Ventilatory Parameters

Parameter	Range	Resolution	Tolerance ⁽¹⁾
Instant Pressure	0 to 120 cmH ₂ O	1	±1cmH ₂ O or ±2% of read
Peak Pressure	0 to 120 cmH ₂ O	1	±1cmH ₂ O or ±2% of read
Mean Pressure	0 to 120 cmH ₂ O	1	±1cmH ₂ O or ±2% of read
Plateau Pressure	0 to 120 cmH ₂ O	1	±1cmH ₂ O or ±2% of read
PEEP	0 to 120 cmH ₂ O	1	±1cmH ₂ O or ±2% of read
Intrinsic PEEP (iPEEP)	0 to 99,9 cmH ₂ O	1	±1cmH ₂ O or ±2% of read
Measured Flow	-180 to 180 L/min	0,1	±50mL/min or ±2% of read
Tidal Volume in PLV with volume guaranteed activated ^{(2) (3) (4)}	0,0 to 10,0 mL	0,1	±2,0mL or ±10% of the measured value
	10 to 100 mL	1	
Tidal Volume ⁽³⁾	0 to 999 mL	1	±2,5mL or ±5% of the measured value
	1,00 to 3,00 L	0,01	
Minute Volume (MV)	0,001 to 99,9 L	0,001	±0,18L or ±3% of the measured value
Inspiratory Time	0,05 to 9,99 s	0,01	±0,01s
	10,0 to 60,0 s	0,1	±0,1s
Expiratory Time	0,05 to 9,99 s	0,01	±0,01s
	10,0 to 60,0 s	0,1	±0,1s
Ratio I:E	1:599 to 599:1	1:0,1	±2%
Total Breathing Rate	0 to 200 bpm	1	±1bpm or ±1% of the measured value

Parameter	Range	Resolution	Tolerance ⁽¹⁾
Spontaneous Rate	0 to 200 bpm	1	±1bpm or ±1% of the measured value
O ₂ Concentration (FiO ₂)	12,0 to 99,9 %	0,1	±1% in volume or ±2% of read
	100 to 110 %	1	
Airway resistance ⁽³⁾ (Ri and Re)	0 to 99,9 cmH ₂ O/L/s	0,1	±5cmH ₂ O/L/s or ±20% of the measured value
	100 to 200 cmH ₂ O/L/s	1	
Dynamics Complacency	0 to 99,9 mL/cmH ₂ O	0,1	±1mL/cmH ₂ O or ±10% of the measured value
	100 to 200 mL/cmH ₂ O	1	
Static Complacency	0 to 99,9 mL/cmH ₂ O	0,1	±1mL/cmH ₂ O or ±10% of the measured value
	100 to 200 mL/cmH ₂ O	1	
External auxiliary pressure	0 to 120 cmH ₂ O	1	±1cmH ₂ O or ±2% of the measured value
Estimated Tracheal Pressure	0 to 120 cmH ₂ O	1	±1cmH ₂ O or ±2%
Elastance	0 to 100 cmH ₂ O/L	1	±1cmH ₂ O/L or ±10% of the measured value
Leakage flow	0,0 to 19,9 L/min	0,1	±50mL/min or ±2% of read
	20 to 180 L/min	1	
Percentage leak	0 to 100 L/min	1	±2%
Time constant (TC)	Calculated(s)	0,1	---
Ti / Ttotal	Calculates(s)	0,1	---
RSBi – Rapid shallow breathing index (IRRS, Tobin index)	Calculated(cycles/min/L)	1	---
WOBi (Imposed Work Of Breathing)	Calculated (J/min)	0,01	---
WOBi (Imposed Work Of Breathing)	Calculated (J/L)	0,01	---
Pi Max	-60 to 120 cmH ₂ O	1	±1mL/cmH ₂ O or ±2% of the measured value

- (1) When two tolerances are indicated, consider the higher value.
- (2) Only with guaranteed volume (VG) enabled.
- (3) For airway resistance greater than 150 cmH₂O/L/s, the expired volume will have its tolerance changed to \pm 10%. In this condition, the measured inspiratory volume remains unchanged.

Observations

- *In practice, the units of measure of pressure are equivalent, being able to adopt that 1 mbar = 1 hPa \approx 1 cmH₂O.*

11.14 Specifications of Alarm and Safety System

- Valve anti-asphyxia to protect against failures in gas supply.
- Safety relief valve 100 cmH₂O as basic standard ventilators in order to avoid overpressure in the breathing circuit safety.
- Active overpressure valve that does not detect obstructions, is activated to reduce the pressure in the breathing circuit.



WARNING

- *Alarms assumed default values whenever the equipment is restarted or any change in patient.*
- *The apnea time may be switched off and in this condition there will be no backup ventilation.*
“THE OPERATOR MUST BE AWARE OF RISK IS KEEPING APNEA ALARM OFF”
- *The automatic adjustment of the alarm is based on the monitored values, therefore, may only be used when the ventilator is NOT in standby mode and preferably when the parameters are stable.*

The priority of the alarm is determined by the equipment of the risk management process.

Table 18 - Alarm priority

Result potential response to the failure cause of the alarm	Start of the potential damage ⁽¹⁾		
	Immediate ⁽²⁾	Ready ⁽³⁾	Late ⁽⁴⁾
Death or irreparable injury	HIGH PRIORITY	HIGH PRIORITY	MEDIUM PRIORITY
Repairable injury	HIGH PRIORITY	MEDIUM PRIORITY	-
Small Injury or discomfort	MEDIUM PRIORITY	-	-

- (1) Start of the potential damage refers to the occurrence of the injury and not to its manifestation.
- (2) There is potential for the event to be developed over a period of time not usually sufficient for manual corrective action.
- (3) There is potential for the event to be developed over a period of time usually sufficient for manual corrective action.
- (4) There is potential for the event takes place in a specified period not greater than that provided in the "prompt".

In this alarm system there is no changing the priority of the alarm condition and occurrence of more than one alarm simultaneously.

- The high-priority alarm messages will be displayed alternately.
- In the absence of high-priority alarms, the medium priority alarm messages are displayed alternately.

Table 19 – Alarm Features

Alarm	Characteristics	High Priority	Medium Priority
Visual	Color	Red	Yellow
	Intermittence frequency	1,6 hz	0,7 hz
Audible	Number of saved pulses	10 pulses	3 pulses
	Interval between sage	5s	5s
	Sound pressure range	65dBA	65dBA
	Pulse Frequency	686 hz	686 hz

11.14.1 Specifications of adjustable alarms

Table 20 – Adjustable alarms

Alarm	Adjust	Limit	Default parameters ⁽¹⁾			Unit
			Neonatal	Pediatric	Adult	
Maximum Pressure	OFF, 0 to 120	High	30	30	40	cmH ₂ O
		Low	OFF	OFF	OFF	
PEEP	OFF, 0 to 80	High	10	15	20	cmH ₂ O
		Low	OFF	OFF	OFF	
Total Volume	OFF, 0 to 3000	High	50 mL	500 mL	1.0 L	L or mL
		Low	OFF	OFF	OFF	
Minute Volume	OFF, 0.0 to 99	High	1.0	10	20	L
		Low	0.5	2	3.6	
Rate	OFF, 0 to 200	High	80	60	60	rpm
		Low	5	5	5	
FiO ₂	OFF, 18 to 100	High	80	80	80	%
		Low	OFF	OFF	OFF	
EtCO ₂ ⁽²⁾	OFF, 0 to 80	High	45	45	45	mmHg
		Low	OFF	OFF	OFF	
CO ₂ Ins ⁽²⁾	OFF, 0 to 80	High	3	3	3	mmHg
Pulse rate ⁽²⁾	OFF, 0 to 240	High	150	120	100	bpm
		Low	OFF	OFF	OFF	
SpO ₂ ⁽²⁾	OFF, 0 to 100	Low	85	85	85	%
Apnea time	OFF, 0 to 60	High	15	15	15	s
Automatic adjust ⁽³⁾	OFF, 10, 20 and 30		OFF			%

(1) Whenever the equipment is turned on or there is an exchange of patient type or end the power of the battery without the ventilator is connected to the power grid, the alarms will assume default values.

(2) Alarms available only with the use of optional external sensors.

(3) Applies only to the basic alarms ventilation (maximum pressure, PEEP, volume, minute volume, rate and FiO₂).

11.14.2 Messages of Ventilator Alarm

In the event of one or more alarms related to the ventilator, the following messages may appear, according to their respective priorities:

Table 21 – High priority alarms

High Priority Alarm	Delay time	Description
INOPERATIVE EQUIPMENT	< 1 s	It indicates that there was a technical failure of the equipment to be replaced.
COMMUNICATION BREAKDOWN	< 1 s	It indicates that there was a technical failure of the equipment to be replaced.
LOW BATTERY	< 1 s	When the internal battery is charging at the end. It should provide adequate means of ventilation of the patient support.
CHECK BATTERY	< 1 s	It indicates a faulty battery. It should provide adequate means of ventilation of the patient support.
LOW PRESSURE – O₂ SUPPLY	< 1 s	The pressure of oxygen is below the specified network. This alarm will not be triggered if the O ₂ % parameter is 21% and the air system is operating within the required specifications.
LOW PRESSURE – AIR SUPPLY	< 1 s	The compressed air supply pressure is below a specified level. This alarm will not be triggered if the O ₂ % parameter is 100% and the Oxygen network is working within the required specifications.
APNEA	< 1 s	It means that the time elapsed since the last inspiration is greater than the set alarm value as the maximum time of apnea.
OBSTRUCTION	< 2 cycles	There is some obstruction in the breathing circuit that prevents the complete or appropriate expiration of the patient.
DISCONNECTION	< 5 cycles	There disconnect the breathing circuit or flow sensor lines (if any), which prevents proper patient ventilation.
HIGH PRESSURE	< 2 cycles	The pressure reached exceeded the alarm value set as the upper limit pressure.
LOW PRESSURE	< 2 cycles	The pressure did not reach the alarm value set as a pressure lower limit.

High Priority Alarm	Delay time	Description
HIGH TIDAL VOLUME	< 3 cycles	The tidal volume delivered to the patient exceeded the value of the adjusted alarm as total volume of upper limit.
LOW TIDAL VOLUME	< 3 cycles	The tidal volume delivered to the patient is below the set alarm value and total volume of lower limit.

Table 22 - Medium priority alarms

Medium Priority Alarm	Delay time	Description
NO AC POWER	< 1 s	It means that there is no power from the power supply.
CHECK LEAKAGE	< 2 cycles	The measured flow leak exceeded the maximum compensation limit.
CHECK FLOW SENSOR	< 3 cycles	It indicates that there are problems with the external flow sensor or is disconnected. Under these conditions all the monitoring that depends on this sensor (VT, MV, Frequency, Vins, Tinsp, I: E, T exp, Cst, DynC, Res, τ , iT, Volume Leak, VxTime Chart) will NOT be displayed. In controlled ventilation modes the volume, the delivered equipment volumes will have a range of up to $\pm 10\%$.
HIGH MINUTE VOLUME	< 3 cycles	The minute volume delivered to the patient exceeded the value of the alarm set as its upper limit.
LOW MINUTE VOLUME	< 3 cycles	The minute volume delivered to the patient is below the set alarm value to its lower limit.
HIGH RATE	< 3 cycles	The respiratory rate of the patient exceeded the alarm value set to its upper limit.
LOW RATE	< 3 cycles	The respiratory rate of the patient exceeded the alarm value set to its lower limit.
HIGH PEEP	< 3 cycles	Positive pressure end-expiratory pressure (PEEP) exceeded the alarm value set to its upper limit.

Medium Priority Alarm	Delay time	Description
LOW PEEP	< 3 cycles	Positive pressure end-expiratory pressure (PEEP) did not reach the alarm value set to its lower limit.
HIGH FIO ₂	< 3 cycles	The fraction of inspired O ₂ exceeded the alarm value set to its upper limit.
LOW FIO ₂	< 3 cycles	O ₂ fraction of inspired not hit the alarm value set to its lower limit.
LIMITED PRESSURE	< 1 s	When the monitored pressure reaches the set pressure limit. In this case the volume delivered by the ventilator module NOT REACHED the adjusted volume due to pressure limitation.



WARNING

- *Upon receiving alarm information, provide prompt service to solve the problem.*
- *So it is terminated the situation that necessitated the total audible alarm silence, one should re-enable it for patient safety.*



ATTENTION

- *To silence the audible alarm, press the quick access button SILENCE. The audible alarms are disabled for the set period or until a new alarm occurs.*
- *There may be dangerous if different pre-alarm settings used for the same equipment or similar equipment in the same area, for example, an intensive care unit or operating room heart.*
- *The equipment always starts with the volume set audio to the maximum level (6), regardless of the level set when it was switched off.*
- *If the volume of audio is set to a value below the maximum level (6), if an alarm while there is no answer to this cease, the volume of audio will be increased gradually every 15 seconds to reach its maximum.*

11.14.3 Messages of Ventilator Alerts

In the event of one or more alerts related to the ventilator, the following messages may be displayed:

Table 23 - Warning Messages

Message	Delay time	Description
ASSISTED FLOW TRIGGER	< 1	It indicates the occurrence of a trigger assisted generated by increasing inspiratory flow.
ASSISTED PRESSURE TRIGGER	< 1 s	It indicates the occurrence of a trigger assisted generated by a pressure drop.
SPONTANEOUS FLOW TRIGGER	< 1 s	It indicates the occurrence of a spontaneous trigger generated by increasing inspiratory flow.
SPONTANEOUS PRESSURE TRIGGER	< 1 s	It indicates the occurrence of a spontaneous trigger generated by a pressure drop.
MANUAL TRIGGER (RED)	< 1 s	It indicates the occurrence of a trigger assisted, manually generated by the operator.
MANUAL TRIGGER (YELLOW)	< 1 s	It indicates the occurrence of a spontaneous trigger generated manually by the operator.
INVERSE I:E RATIO	< 1 s	It indicates that ratio I:E It is inverse, ie the time of the inspiratory phase is greater than the time of the expiratory phase.

11.14.4 Messages of IRMA CO₂ sensor Alarm

In the event of one or more alarms related to IRMA CO₂ sensor, the following messages may appear, according to their respective priorities:

Table 24 - High priority alarms

High priority alarms	Delay time	Description
HIGH EtCO₂	< 3 s	The CO ₂ tax expired exceeded the alarm value set as the upper limit of EtCO ₂ .
LOW EtCO₂	< 3 s	The CO ₂ tax expired is below alarm value set as the lower limit of EtCO ₂ .
HIGH FiCO₂	< 3 s	The inspired CO ₂ rate exceeded the alarm value set as the upper limit of CO _{2i} .
IRMA SOFTWARE ERROR	< 3 s	It indicates whether to disconnect and reconnect the CO ₂ sensor.

High priority alarms	Delay time	Description
IRMA HARDWARE ERROR	< 3 s	It indicates that the CO ₂ sensor should be changed.
IRMA REPLACE ADAPTER	< 3 s	It indicates that the airway adapter must be replaced.
IRMA REPLACE ADAPTER	< 3 s	It indicates that the airway adapter must be properly connected.
FACTORY CALIBRATION LOST/MISS	< 3 s	It indicates that the sensor has lost its original factory calibration.
MOTOR SPEED OUT OF BOUNDS	< 3 s	It indicates that the engine sensor is out of range.

Table 25 - Medium priority alarms

Medium priority alarms	Delay time	Description
IRMA CO ₂ OUTSIDE SPECIFIED	< 3 s	It indicates that the CO ₂ reading is outside the specified range.
IRMA PARAM OUTSIDE SPECIFIED	< 3 s	It indicates that a parameter is outside the specified range and prevents the correct reading of CO ₂ .
IRMA ZERO REF REQUIRED	< 3 s	It indicates the need for resetting (offset) of the CO ₂ sensor.



WARNING

- *Upon receiving alarm information, provide prompt service to solve the problem.*
- *So it is terminated the situation that necessitated the total audible alarm silence, one should re-enable it for patient safety.*



ATTENTION

- *There may be dangerous if different pre-alarm settings used for the same equipment or similar equipment in the same area, for example, an intensive care unit or operating room heart.*

11.14.5 Messages of oximeter Alarm

In the event of one or more alarms related to the oximeter, the following messages may appear, according to their respective priorities:

Table 26 – High priority alarm

High Priority Alarm	Time Delay	Description
HIGH PULSE RATE	< 3 s	The patient's pulse rate exceeded the alarm value set to its upper limit.
LOW PULSE RATE	< 3 s	The patient's pulse rate is below the set alarm value to its lower limit.
LOW SpO ₂	< 3 s	O ₂ saturation rate is below the set alarm value as the lower limit of SpO ₂ .
SpO ₂ BOARD FAILURE	< 3 s	Failed on the electronic board Oximeter.

Table 28 – Medium priority alarm

Medium priority alarm	Time Delay	Description
SpO ₂ DEFECTIVE SENSOR	< 3 s	No defect possibility in the SpO ₂ sensor.
SpO ₂ SENSOR OFF PATIENT	< 3 s	It indicates that the sensor is out the patient's finger.
SpO ₂ NO SENSOR	< 3 s	The sensor does not exist or is not properly connected.
LOW PERFUSION	< 3 s	Indicates low perfusion index.
PULSE SEARCH	< 3 s	Search for pulse being held.
SpO ₂ UNRECOGNIZED SENSOR	< 3 s	Could not recognize the sensor used.
INTERFERENCE DETECTED	< 3 s	Light interference was detected.
TO MUCH AMBIENT LIGHT	< 3 s	Excess light detected environment.
SpO ₂ NO CABLE	< 3 s	Indicates the possibility of the cable is disconnected.
NO ADHESIVE SENSOR	< 3 s	Indicates the absence of the adhesive sensor, if applicable.
SpO ₂ LOW IQ SIGNAL	< 3 s	The IQ signal is low.

**WARNING**

- *Upon receiving alarm information, provide prompt service to solve the problem.*
 - *So it is terminated the situation that necessitated the total audible alarm silence, one should re-enable it for patient safety.*
-

**ATTENTION**

- *There may be dangerous if different pre-alarm settings used for the same equipment or similar equipment in the same area, for example, an intensive care unit or operating room heart.*
-

11.15 Specifications of performance

Table 19 - Performance Specifications

Parameter	Specifications		Unit	Tolerance
Valves Response Time $T_{0,90}$	5		ms	± 20%
Maximum Flow in Pressure Support and Spontaneous Breathing	180		L/min	± 10%
Maximum flow leakage compensated	Neonate	20	L/min	± 10%
	Pediatric and Adult	50	L/min	± 10%

Observations

- Controlled ventilation pressure is recommended for larger leak flows than the limit specified above.
- In this case the maximum flow offset can be greater than 100 L / min.

11.16 Specifications of Expiratory Limb Resistance

Table 30 - Branch resistance specifications expiratory

Breathing circuit	Flow (L/min)	Expiratory resistance (hPa or cmH ₂ O)			
		Circuit	Circuit + Flow Sensor	Circuit + Flow Sensor + Filter HME	Circuit + Flow Sensor + CO ₂ Sensor+ HME Filter
Neonate	5,0	0,6	1,7		
Pediatric	30,0	0,4	3,4	4,1	4,3
Adult	60,0	0,8	1,4	3,1	3,5
Adult	60,0	3,8	4,4	6,1	6,5

11.17 Specifications of Maintenance and Calibration

Table 31 - Maintenance and calibration specifications

Description	Specifications	Tolerance
Review and replacement of exhalation valve's diaphragm	Under inspection or 5,000 hours or 12 months (whichever occurs first)	± 500 h / ± 1 months
Review and replacement of the galvanic cell O ₂	Recommended replacement if there are problems in the calibration or 10,000 hours or 24 months (whichever occurs first)	
Review and replacement of the internal batteries	10.000 hours or 24 months (whichever occurs first)	
Equipment Review	5.000 hours or 12 months (whichever occurs first)	
Equipment Calibration	5.000 hours or 12 months (whichever occurs first)	
Expiration date	INDEFINITE ⁽¹⁾	---

(1) The expiration date is undetermined when respected and implemented regular reviews

11.18 Specifications of IRMA CO₂ sensor

Table 32 - Sensor IRMA CO₂ – General Specifications

General Specifications	
Description	Monitoring sensor "mainstream" with infrared technology.
Dimensions (L x P x A)	38 x 37 x 34mm (1,49" x 1,45" x 1,34")
Cable length	2,50m (± 0,02m)
Weight	< 25g (without cable) < 38g (without cable)
Operating Temperature	0 to 40°C / 32 to 104°F
Temperature Storage and Transportation	-40 to 75°C / -40 to 167°F
Operation Humidity	10 to 95% RH, non-condensing.
Storage and Transportation Humidity	5 to 100% RH, condensing. ⁽¹⁾ ⁽¹⁾ After being in an environment with condensation, the drive must be stored for more than 24 hours in an environment with moisture equivalent to Operating Humidity.
Atmospheric Pressure operation	525 to 1200cmH ₂ O (525cmH ₂ O corresponds to an altitude of 4572m or 15000 feet).
Atmospheric pressure Storage and Transport	500 to 1200cmH ₂ O.

General Specifications	
Mechanical resistance	It withstands repeated drops of 1m onto a hard surface. According to the standard requirements for ambulances (EN 1789: 2004 - clause 6.4) and requirements against shock and vibration (ISO 80601-2-55 - ed.1)
Source of Power Supply	4,5 to 5,5 VDC, Max 1,0W (power measured with 5V and less than 350mA for 200ms).
Surface temperature (Ambient temperature 23 ° C)	Max: 41°C / 106°F.
Airway Adapter	<u>Adult/Pediatric (Disposable):</u> Adds less than 6ml deadspace; Lower pressure loss than 0,3cmH20 to 30L / min. <u>Neonate (Disposable):</u> Add 1ml less than deadspace; Lower pressure loss than 1,3cmH20 to 10L / min.

Table 33 - Sensor IRMA CO₂ – Outputs

Outputs	
Breath Detection	Adaptive threshold, minimum 1% of the volume change in CO ₂ concentration.
Respiratory rate	0 to 150bpm. The respiratory rate is shown every 3 breaths and the average value is updated every breath.
Fi and ET	Fi and ET are shown after a breath and their averages are continuously updated.
Waveforms	CO ₂ .
Diagnostic Parameters	Atmospheric pressure, review of software and hardware, serial number.
Informations	Detection New Breathing, Apnea, Check Adapter, and Sensor Accuracy Unspecified Error.

Table 34 - Sensor IRMA CO₂ – Gas analyzer

CO₂ gas analyzer	
Sensor	Gas analyzer having 2 to 9 channels NDIR (Non-Dispersive Infrared or "Non-Dispersive Infrared") which measures in the range of 4 to 10µm. It puts pressure correction, temperature and interference in the entire spectral range.
Calibration	Zeroing recommended every exchange of Airway Adapter. Without requiring specific calibration of the IR.

“Warm-up”	Information on concentration is analyzed and sent every 10 seconds. Total accuracy in measurements: 1 minute.
Rise time (a 10 L/min)	CO ₂ ≤ 90ms.
Total System Response Time	< 1s.

Table 35 - Sensor IRMA CO₂ – Exactness / accuracy I

Exactness / accuracy of the measures (under standard conditions)		
Gas Type	Band (AX+)	Exactness / accuracy
CO ₂	0 to 15	±(0,2 vol% + 2% reading)
	15 to 25	Not specified
<i>Note: Concentration of gases in percentage volume units.</i>		

Table 36 - Sensor IRMA CO₂ – Exactness / accuracy II

Exactness / accuracy of measurements (under all conditions)	
Gas Type	Exactness / accuracy
CO ₂	±(0,3 vol% + 4% reading)
<i>Note: The accuracy specification is valid for any environmental condition specified, except as expressed in the table below with "Effects of Gas and Steam interference".</i>	

Table 37 - Sensor IRMA CO₂ – Effects of interference gases and steam

Effects of gas and steam interference		
Gas or steam	Gas level	CO ₂
N ₂ O	60 vol%	--- (1 e 2)
HAL	4 vol%	--- (1)
ENF, ISO, SEV	5 vol%	+8% measure read. ⁽³⁾
DES	15 vol%	+12% measure read. ⁽³⁾
Xe (Xenon)	80 vol%	-10% measure read. ⁽³⁾
He (Helio)	50 vol%	-6% measure read. ⁽³⁾
Propellant metered dose inhaler	It not designed for use with propellant metered dose inhaler.	
C ₂ H ₅ OH (Ethanol)	0,3 vol%	--- (1)
C ₃ H ₇ OH (Isopropanol)	0,5 vol%	--- (1)
CH ₃ COCH ₃ (Acetone)	1 vol%	--- (1)

Effects of gas and steam interference		
CH ₄ (Methane)	3 vol%	--- (1)
CO (Carbon Monoxide)	1 vol%	--- (1)
NO (Nitrogen Monoxide)	0,02 vol%	--- (1)
O ₂	100 vol%	--- (1 e 2)

(1) Negligible interference. Interference effects do not change the values in Table "Accuracy / accuracy of measurements (under all conditions)" above.

(2) For sensors that are not measuring N₂O and / or O₂, concentrations must be entered manually by the user.

(3) Interference in the indicated gas level. For example, 50 vol% of helium typically decrease the values read in CO₂ by 6%. This means that the mixture contains 5.0 vol% CO₂ and 50 vol% of helium, measurement of CO₂ concentration is normally calculated in this way:

$$(1 - 0,06) * 5,0 \text{ vol\%} = 4,7 \text{ vol\% CO}_2.$$

11.19 Electromagnetic Compatibility

Changes or modifications to this equipment not expressly approved the MAGNAMED can cause EMC issues with this or other equipment. Contact the MAGNAMED to receive technical assistance.

This equipment has been designed and tested to comply with the EMC standards applicable as described below:

- Immunity: IEC 60601-1-2
- Emission: CISPR11
- Approvals: OS/IEC 60601-1



WARNING

- *The use of cell phones or other transmitting equipment of radio frequency (RF) near the system may cause unexpected or adverse outcomes. Monitor the operation if there is radio emission sources in the vicinity.*
- *The use of other electrical equipment on or around the system may cause interference. Before use in the patient, you should check that the equipment usually works in the defined configuration.*

11.19.1 Manufacturer declaration – Electromagnetics emissions

The system is intended for use in an electromagnetic environment specified below and therefore, it is recommended that the client or user of the system ensures that it is used in such an environment.

Emission Test	Compatibility	Directive for Electromagnetic Environment
RF Emissions ABNT NBR IEC CISPR 11	Group 1	The system uses RF energy only for its internal functions. However, its RF emissions are very low and are not likely to cause any interference in nearby electronic equipment.
RF Emissions ABNT NBR IEC CISPR 11	Class B	The system can emit electromagnetic energy to perform its functions intended. electronic equipment nearby may be affected. It is suitable for use in all establishments including domestic establishments and those directly connected to the public power grid low voltage
Harmonics emissions IEC 61000-3-2	Class A	
Emissions due to voltage fluctuation / flicker IEC 61000-3-3	Compliant	

11.19.2 Manufacturer declaration – Electromagnetic immunity

The system is intended for use in an electromagnetic environment specified below and therefore, it is recommended that the client or user of the system ensures that it is used in such an environment.

Immunity Test	Test level IEC 60601-1-2,	Compliance	Policy to electromagnetic environment
IEC 61000-4-2 - Electrostatic discharge (ESD)	± 6 kV by contact ± 8 kV by air	± 6 kV by contact ± 8 kV by air	Floors should be wood, concrete or ceramic. If floors are covered with synthetic material, the relative humidity should be at least 30%
IEC 61000-4-4 – Electrical fast transient / pulse train (“Burst”)	± 2 kV on supply lines ±1 kV the input / output lines	± 2 kV on supply lines ±1 kV the input / output lines	Quality power supply should be that of a typical commercial or hospital environment.
IEC 61000-4-5 - Outbreakes	± 1 kV lines(s) to lines(s) ±2 kV lines(s) to earth	± 1 kV lines(s) to lines(s) ±2 kV lines(s) to earth	Quality power supply should be that of a typical commercial or hospital environment.
IEC 61000-4-11 – Voltage dips, short interruptions and voltage variations on power supply input lines	< 5% U_T (> 95% of voltage drop in U_T) for 0,5 cycle 40% U_T (60% of voltage drop in U_T) for 5 cycles 70% U_T (30% of voltage drop in U_T) for 25 cycles < 5% U_T (> 95% of voltage drop in U_T) for 5 seconds.	< 5% U_T (> 95% of voltage drop in U_T) for 0,5 cycle 40% U_T (60% of voltage drop in U_T) for 5 cycles 70% U_T (30% of voltage drop in U_T) for 25 cycles < 5% U_T (> 95% of voltage drop in U_T) for 5 seconds.	Quality power supply should be that of a typical commercial or hospital environment.
Magnetic field of power frequency (50/60 Hz) IEC 61000-4-8	3 A/m	3 A/m	Magnetic fields in the frequency of the supply should be at levels characteristic of a typical location in a typical commercial or hospital environment

Note: U_T is the voltage a.c. before application of the test level.

11.19.3 Radiated Immunity

Immunity Test	Test Level ABNT NBR IEC 60601	Conformity	Electromagnetic environment - Guidelines Distance removal recommended
			Portable and mobile RF communications equipment should not be used near any part of the system, including cables, with a separation distance than recommended, calculated from the equation applicable to the frequency of the transmitter.
RF conduced IEC 61000-4-6	3 Vrms 150 kHz to 80 MHz out of band ISM ^(a)	(?)1 Vrms (V1)	$D = 3.5/V_1 \sqrt{P}$
	10 Vrms 150 kHz to 80 MHz out of band ISM ^(a)	(?)1 Vrms (V2)	$D = 12/V_2 \sqrt{P}$
RF radiated IEC 61000-4-6	10 V/m	(?)10 V/m (E1)	$D = 12/E_1 \sqrt{P}$ 80 MHz to 800 MHz
	80 MHz to 2,5 GHz		$D = 23/E_1 \sqrt{P}$ 800 MHz to 2,5 GHz
			Where P is the maximum output power of the transmitter in watts (W) according to the manufacturer's transmitter, and D is the recommended spacing distance in meters (m) (b). The field intensity established by the RF transmitter, as determined by an electromagnetic site inspection (c) should be less than the compliance level in each frequency range ^(d) .

^(a) The bands ISM (industrial, scientific and medical) between 150 kHz to 80 MHz are 6,765 MHz to 6,795 MHz; 13,553 MHz to 13,567 MHz; 26,957 MHz to 27,283 MHz; and 40,66 MHz to 40,70 MHz.

^(b) Compliance levels in the ISM bands between 150 kHz and 80 MHz and 80 MHz to 2.5 GHz frequency band is intended to reduce the likelihood of mobile and portable communications equipment causing interference if inadvertently brought into the patient's environment . For this reason, an additional factor of 10/3 is used in the recommended separation distance calculation for transmitters in these frequency bands.

^(c) Field strengths from fixed transmitters, such as base stations, telephone (cellular / wireless) land mobile radios, amateur radio, AM and FM radio broadcast and TV broadcast can not be predicted theoretically with accuracy. To assess the electromagnetic environment due to fixed RF transmitters, consider an electromagnetic inspection of the site. If the measured field strength in the location where the system is used exceeds the RF compliance level above apply, the system should be observed to see whether the operation is normal. If abnormal performance is observed, additional measures may be necessary, such as reorienting or system replacement.

^(d) Above 150 kHz to 80 MHz frequency range, the field strength should be less than $[V1] V / m$.

Recommended separation distances between portable RF communication equipment and mobile system

The system is intended for use in the electromagnetic environment in which radiated RF disturbances are controlled. The customer or user of the system can help prevent electromagnetic interference by maintaining a minimum distance between RF communications equipment (transmitters) portable and mobile and the system as recommended below, according to the maximum output power of the communication equipment.

Separation distance according to frequency of transmitter (m)

Maximum rated power output of the transmitter (W)	150 kHz to 80 MHz Outside the bands ISM	150 kHz to 80 MHz In the bands ISM	80 MHz to 800 MHz	800 MHz to 2,5 GHz
	$D = \left[\frac{3,5}{V1} \right] \sqrt{P}$	$D = \left[\frac{12}{V2} \right] \sqrt{P}$	$D = \left[\frac{12}{E1} \right] \sqrt{P}$	$D = \left[\frac{23}{E1} \right] \sqrt{P}$
0,01	0,35	1,2	0,12	0,23
0,1	1,1	3,8	0,38	0,73
1	3,5	23	1,2	2,3
10	11	38	3,8	7,3
100	35	120	12	23

For transmitters with a nominal maximum power not listed output above, the distance recommended D separation in meters (m) can be determined using the equation applicable to the frequency of the transmitter, where P is the maximum output power of the transmitter in watts (W) according to the transmitter manufacturer.

Note 1 At 80 MHz and 800MHz, applies to the separation distance for the higher frequency range.

Note 2 In the ISM frequency bands (industrial, scientific and medical) between 150 kHz and 80 MHz are 6.765 MHz to 6.795 MHz; 13.553 MHz to 13.567 MHz; 26.957 MHz to 27.283 MHz; and 40.66 MHz to 40.70 MHz.

Note 3 An additional factor of 10/3 is used in calculating the recommended separation distance for transmitters in the ISM frequency bands between 150 kHz and 80 MHz and in the frequency range 80MHz to 2.5GHz to reduce the probability of interference that equipment Mobile communication / laptop could cause inadvertently brought into patient areas.

Note 4 These guidelines may not apply in all situations. Electromagnetic propagation is affected by absorption and reflection from structures, objects and people.

11.19.4 Electrical safety

The following are the precautions that should be observed when combining these items (not medical equipment) with the system.



WARNING

- *Items that do not comply the requirements of IEC 60601-1 should not be placed within 1.5 m of the patient.*
- *All items (electromedical equipment or not) connected to the system output signal cable / input must receive power from a source of alternating current using separate transformer (according to IEC 60989) or have protective conductor additional land.*
- *Do not connect directly electrical equipment nonmedical the AC wall outlet. Using AC power supply with own transformer. Otherwise, the leakage current increase above the levels accepted by the IEC 60601-1 under normal terms and conditions of a single failure. This may cause dangerous electrical shock to the patient or operator.*
- *After connecting any equipment into these outlets, subject the system to a complete test leakage current (according to IEC 60601-1).*
- *The electromedical system operator shall not touch electrical equipment no doctor and the patient simultaneously. This may cause dangerous electrical shock to the patient or operator.*

12 IRMA CO₂ Sensor (Optional)

12.1 Intended Use

The “mainstream” IRMA™ sensor has been designed for monitoring respiratory gases in adult, child, and newborn patients, during anesthesia and at ITUs, surgical centers, and emergency-rooms.

Consists of a set having a one-way sensor with technology of up to nine channels of Non-Dispersive Infrared or “NDIR” to spot the gases, a barometric pressure sensor, an electric tension regulator, and a microprocessor. The unit weight less than 0.88 ounces.

Carbon Dioxide (CO₂) concentrations are monitored together with other parameters such as Breathing Rate (or Respiratory Rhythm – RR), the wave of gases, and concentration of each gas during inspiration and expiration.

The IRMA airway adapter fits perfectly in the IRMA gases sensor. This equipment uses XTP™ window technology. The airway adapter must be positioned between the endotracheal tube and the respiratory circuit, which permits XTP windows positioned on the sides of the sensor to measure gas concentrations.

Operating in a continuous, standard, low-intensity electrical tension, the IRMA sensor was designed to meet portability requirements and low energy consumption, typically below 1 Watt. It was designed to be extremely easy to integrate with any monitoring device, permitting the visualization of information on gases on real time.

12.2 Use Instructions

The IRMA sensor has been designed for use to the Magnamed ventilators and to any other compatible monitoring device. Its function is to real-time monitor the gas concentration signal and value.

It must not be used as the only means of monitoring the patient. It must always be used with a vital sign monitoring equipment. This monitoring must be accompanied by a specialist that is capable of analyzing patient conditions.

The IRMA sensor was developed to be used by trained and authorized healthcare professionals.

12.2.1 Sensor Assembly

1. Connect the IRMA sensor cable to the ventilator and connect it to the device;
2. Insert the airway adapter into the IRMA sensor. You will hear a click after the airway adapter is inserted correctly into the sensor;



Figure 8 –Airway sensor socket

3. The green LED will indicate that the IRMA sensor is ready for use.

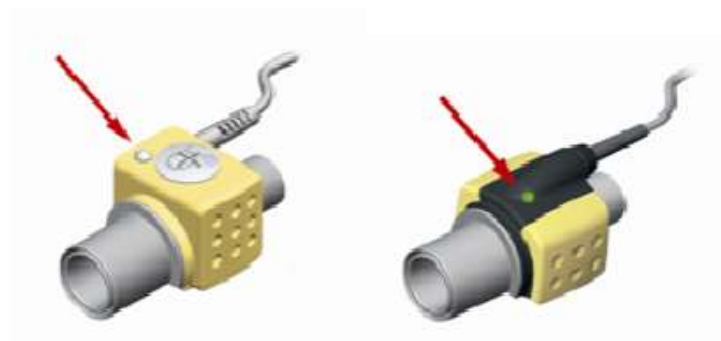

Figure 9 - LED indicates if the sensor is ready for use

4. Connect the 15 mm adult IRMA airway adapter to the respiratory circuit's "Y" part;



Figure 10 - Airway adapter connection to the patient's Endotracheal Tube

5. Connect the 15 mm adult IRMA airway adapter to the patient's Endotracheal Tube;



Figure 11 - Airway adapter connection to the patient's Endotracheal Tube

6. In the event there is a need to connect a Heat Moisture Exchanger (HME), place it between the IRMA sensor and the Endotracheal Tube. Placing the Moisture Exchanger in front of the sensor will protect the airway adapter from secretions and water vapor effects, which eliminates the need of changed the adapter during use.



Figure 12 - Assembly scheme with Moisture Filter

12.2.2 Sensor Positioning

It is extremely important to avoid direct contact between the IRMA sensor and the patient's body when connection the IRMA sensor to a pediatric patient's ventilatory circuit.

In the event it is not possible to avoid, for whichever reason, the sensor's direct contact to any part of the child's body; an isolating material must be placed between the IRMA sensor and the body.



WARNING

- *The sensor must not have direct contact with the patient during use.*

12.2.3 Sensor Reset Procedure

In order to ensure the high precision of the measured valued by the IRMA sensors, the following reset recommendations must be followed.



WARNING

- *Incorrect reset of the sensor will result in incorrect reading of the measured values.*



Observation

- *The reset option sensor will be available in VENT OPTIONS window, so that the sensor is identified and it is ready for use.*
- *It may take a few seconds until the sensor is ready for the process of reset.*

The reset must be done by connecting an airway adapter to the IRMA sensor without connecting them to the respiratory circuit. When the gases monitoring signals have their values stable, the Button is pressed to start zeroing (CONFIG menu).

Special care should be taken in order to avoid close respiration to the sensor before or during the reset. The presence of ambient air (21% of O₂ and 0% of CO₂) through the airway adapter is of crucial importance for a successful reset. If the error message upon calibration appears immediately after the zeroing procedure, it shall be repeated.

The reset must be executed every time the airway adapter is substituted. It must also be performed whenever there is baseline dislocation (offset) in some of the gases measurements or when some of the alarm messages are displayed: "IRMA – OUT OF INTERVAL PARAMETER", "IRMA – CO₂ OUT OF INTERVAL" or "IRMA – ZEROING SENSOR".

After turning on the sensor or exchanging the airway adapter, wait at least a minute before beginning the reset procedure in order for the IRMA sensor to warm-up.

The green LED on the sensor will be intermittent for 5 seconds while the reset process is in progress.

12.2.4 Information about the LED status

Table 38 - LED of status IRMA CO₂

Color (status)	Meaning
Green (constantly on)	System OK
Green (intermittent)	Reset in Progress
Blue (constantly on)	Anesthetic agent present
Red (constantly on)	Sensor Error
Red (intermittent)	Verify the adapter

12.3 Preventive Maintenance

Gas calibration must be verified at regular intervals through reference instruments.

12.4 Cleaning and Disinfection

For process of cleaning and disinfection of IRMA CO₂ sensor, see chapter 8.2.3.

12.5 Important Notes



WARNING

- *The IRMA CO₂ sensor must be operated by trained and authorized medical staff.*
- *The sensor should not be used with flammable anesthetic agents.*
- *Airway adapters should not be reused.*
- *The reuse of a disposable adapter may cause cross infection.*
- *Airway adapters should be disposed of in accordance with local regulations for medical discharges.*
- *Do not use the adapter adult / pediatric airway in neonates, as the adapter adds a dead space of 6 mL in the patient breathing circuit.*
- *Do not use the roads adapter air neonate in adult patients because this adapter can add excessive resistance.*

- *Measures may be affected by communication equipment by radio frequency or by cell phones.*
- *The user must make sure that the sensor will be used in environments according to the electromagnetic environment specifications expressed in this manual.*
- *Do not use the airway adapter with inhalers with measured doses or nebulized medications because they can affect the light transmission within the sensor windows.*
- *The IRMA CO2 sensor is designed to be an adjunct device in patient monitoring, so your information should be analyzed together with other measurements and symptoms.*
- *Incorrect reset can result in erroneous measurements.*
- *Replace the airway adapter if there is condensation inside the adapter.*
- *Use only airway adapters produced by Masimo.*
- *The sensor should not come into direct contact with the patient during use.*
- *Do not connect the adapter air routes between the endotracheal tube and the elbow of the breathing circuit, as this may cause the patient secretions to block the adapter windows, causing an incorrect operation of the sensor.*



Figure 13 – Incorrect and correct positioning of the airway adapter



ATTENTION

- *Do not apply voltage to the sensor cable.*
- *Do not use the sensor in environments whose specifications are outside the limits set out in its technical specification.*

13 Pulse Oximeter (optional)

13.1 Intended Use

The Masimo MS-2040 Pulse oximeter is an auto sufficient solution allowing secure measuring of SpO₂, heart frequency, perfusion index, and PVI, even on the move or at low perfusion.

13.2 Principle of Operation

A Masimo SET® oximeter pulse MS panel is based on three principles:

1. Oxy-hemoglobin and deoxy-hemoglobin absorption differential of red and infrared lights (spectrophotometrics).
2. The volume of arterial blood in the tissue and the light absorbed in the blood alterations (plethysmography).
3. Arterio-venous derivation is highly variable and that fluctuation absorbance trough by venous blood is a major component during the pulse.

The Masimo SET MS board pulse oximeter as well as traditional pulse oximetry determines SpO₂ by passing red and infrared light into a capillary bed and measuring changes in light absorption during the pulsatile cycle. Red and infrared light-emitting diodes (LEDs) in oximetry sensors serve as the light sources, a photodiode serves as the photodetector

Traditional pulse oximetry assumes that all pulsations in the light absorbance signal are caused by oscillations in the arterial blood volume. This assumes that the blood flow in the region of the sensor passes entirely through the capillary bed rather than through any arterio-venous shunts. The traditional pulse oximeter calculates the ratio of pulsatile absorbance (AC) to the mean absorbance (DC) at each of two wavelengths, 660 nm and 905 nm:

$$S(660)=AC(660)/DC(660)$$

$$S(905)=AC(905)/DC(905)$$

The oximeter then calculates the ratio of these two-arterial pulse-added absorbance signals:

$$R = S(660) / S(905)$$

This value of R is used to find the saturation SpO₂ in a look-up table built into the oximeter's software. The values in the look-up table are based upon human blood studies against a laboratory co-oximeter on healthy adult volunteers in induced hypoxia studies.

The Masimo SET MS board pulse oximeter assumes that arterio-venous shunting is highly variable and that fluctuating absorbance by venous blood is the major component of noise during the pulse. MS board decomposes S(660) and S(905) into an arterial signal plus a noise component and calculates the ratio of the arterial signals without the noise:

$$S(660)=S_1+N_1$$

$$S(905)=S_2+N_2$$

$$R= S_1/S_2$$

Again, R is the ratio of two arterial pulse-added absorbance signals and its value is used to find the saturation SpO₂ in an empirically derived equation into the oximeter's software. The values in the empirically derived equation are based upon human blood studies against a laboratory co-oximeter on healthy adult volunteers in induced hypoxia studies.

The above equations are combined and a noise reference (N') is determined:

$$N' = S(660) - S(905) \times R$$

If there is no noise N' = 0: then S(660) = S(905) x R which is the same relationship for the traditional pulse oximeter.

The equation for the noise reference is based on the value of R in the searched value to determine SpO₂. MS card software scans all possible values of R corresponding to SpO₂ values between 1% and 100% and generates a value N' to each of these values R. The signals S (660) and S (905) are processed noise for each possible N' reference for an adaptive cancellation correlation (ACC) which produces a power output versus possible SpO₂ value as shown in the following figure where R corresponds to SpO₂ = 97%:

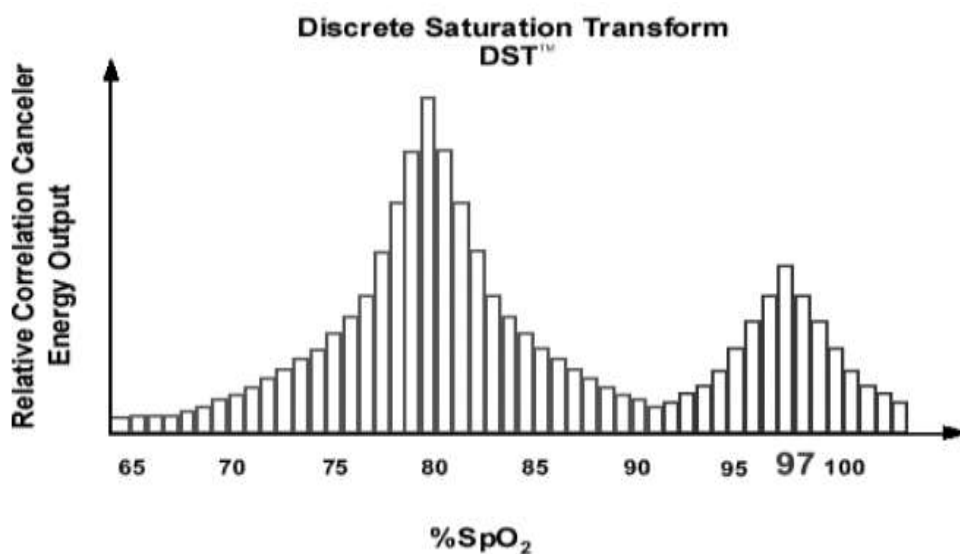

The DST plot has two peaks: the peak corresponding to the higher saturation is selected as the SpO₂ value. This entire sequence is repeated once every two seconds on the most recent four seconds of raw data.

The MS board SpO₂ therefore corresponds to a running average of arterial hemoglobin saturation that is updated every two seconds.

13.3 Important Notes

ATTENTION

- *Explosion hazard. Do not use the MS board pulse oximeter in the presence of flammable anesthetics or other flammable substance in combination with air, oxygen-enriched environments, or nitrous oxide.*
- *A pulse oximeter should NOT be used as an apnea monitor.*
- *Pulse rate measurement is based on the optical detection of a peripheral flow pulse and therefore may not detect certain arrhythmias. The pulse oximeter should not be used as a replacement or substitute for ECG based arrhythmia analysis.*
- *A pulse oximeter should be considered an early warning device. As a trend towards patient deoxygenation is indicated, blood samples should be analyzed by a laboratory co-oximeter to completely understand the patient's condition.*
- *The MS board pulse oximeter is to be operated by qualified personnel only.*
- *This manual, accessory directions for use, all precautionary information, and specifications should be read before use.*
- *Electric shock hazard. Do not remove the monitor cover except to replace the battery.*
- *The operator may only perform maintenance procedures specifically described in this manual.*
- *Contact MAGNAMED technical support for oximeter repairs.*
- *As with all medical equipment, carefully route patient cabling to reduce the possibility of patient entanglement or strangulation.*
- *Interfering Substances:*
 - *Carboxyhemoglobin may erroneously increase readings. The level of increase is approximately equal to the amount of carboxyhemoglobin present.*

-
- *Dyes, or any substance containing dyes, that change usual arterial pigmentation may cause erroneous readings.*
 - *Do not use the sensors during magnetic resonance imaging (MRI) scanning:*
 - *Induced current could potentially cause burns.*
 - *The pulse oximeter may affect the MRI image, and the MRI unit may affect the accuracy of the oximetry measurements.*
 - *If the accuracy of any measurement does not seem reasonable, first check the patient's vital signs by alternate means and then check the pulse oximeter for proper functioning.*
 - *The oximeter can be used during defibrillation; however, the readings may not be accurate for a short period of time.*
 - *Before use, carefully read the LNOP / LNCS sensor directions for use.*
 - *Use only Masimo oximetry sensors for SpO2 measurements.*
 - *Tissue damage can be caused by incorrect application or use of an LNOP / LNCS sensor.*
 - *Inspect the sensor site as directed in the sensor Directions for Use to ensure skin integrity and correct positioning and adhesion of the sensor.*
 - *Do not use damaged LNOP / LNCS sensors.*
 - *Do not use an LNOP / LNCS sensor with exposed optical components.*
 - *Do not immerse the sensor in water, solvents, or cleaning solutions (the sensors and connectors are not waterproof).*
 - *Do not sterilize by irradiation, steam, or ethylene oxide.*
 - *See the cleaning instructions in the directions for use for reusable Masimo LNOP®/ LNCS® sensors.*
 - *Do not use damaged cables.*
 - *Do not immerse the patient cables in water, solvents, or cleaning solutions (the patient cable connectors are not waterproof). Do not sterilize by irradiation, steam, or ethylene*

oxide.

- See the cleaning instructions in the directions for use for reusable Masimo LNOP/LNCS patient cables.



ATTENTION

- **Caution at cleaning:**
 - Do not steam-sterilize, pressure-sterilize, or gas-sterilize the Oximeter
 - Do not wet up or dive the monitor into any liquid.
 - Use cleaning solutions with moderation. Excess solution may run into the monitor and cause internal damages to the components.
 - Do not touch, press, or scrub the display panel with abrasive cleaning components, brushes, cleaning instruments, and do not leave it in contact with anything to scratch the panel.
 - Do not use solutions derived by petroleum or acetones, or other abrasive solvents to clean the oximeter. These substances attack the device's materials and may result in its failure.
- **Inaccurate measures may be caused by:**
 - Incorrect sensor application or use
 - Significant levels of dysfunctional hemoglobins. (e.g., carboxyhemoglobin or methemoglobin)
 - Intravascular dyes such as indocyanine green or methylene blue.
 - Exposure to excessive illumination, such as surgical lamps (especially ones with a xenon light source), bilirubin lamps, fluorescent lights, infrared heating lamps, or direct sunlight (exposure to excessive illumination can be corrected by covering the sensor with a dark or opaque material)
 - Excessive patient movement.
 - Venous pulsations.

- *Placement of a sensor on an extremity with a blood pressure cuff, arterial catheter, or intravascular line.*
 - *Loss of pulse signal can occur in any of the following situations:*
 - *The sensor is too tight*
 - *There is excessive lighting from light sources with a surgical lamp, a bilirubin lamp, or sunlight.*
 - *The blood pressure cuff is inflated at the same extremity of where the SpO2 sensor attached.*
 - *The patient has hypotension, severe vasoconstriction, severe anemia, or hypothermia.*
 - *There is an arterial occlusion next to the sensor.*
 - *The patient is under cardiac arrest or shock.*
-

14 Technical Service















WARNING



- *The FlexiMag Plus ventilators are life support equipments and so if any repairs or maintenance on that equipment necessary find only the authorized service MAGNAMED.*
 - *DO NOT use the equipment if it is not working according to the specifications contained in this operating manual.*
 - *Before sending the equipment to the technical service STRICTLY observe the process of cleaning and disinfection.*
-

15 Symbology

15.1 Symbols used in equipment













Table 39 – Symbols used in equipment





Symbols	Description
	PREVENTIVE MAINTENANCE PERIOD
	EQUIPMENT CLASS II
	EQUIPMENT WITH APPLIED PARTS TYPE BF PROOF OF DEFIBRILLATION
IPX1	IPX1 INGRESS PROTECTION IPX1 FOR PROTECTION FLUID PENETRATION
	CONFORMITY CE: INDICATES THAT THE SYSTEM IS IN ACCORDANCE WITH DIRECTIVE OF THE EUROPEAN COUNCIL 93/42/EEC FOR MEDICAL EQUIPMENT
	AUTHORIZED REPRESENTATIVE IN THE EUROPEAN COMMUNITY
	ATTENTION! CONSULT ACCOMPANYING DOCUMENTS
	CONSULT OPERATING INSTRUCTIONS
	EQUIPMENT COLLECTION ELECTRICAL / ELECTRONIC MADE OF SEPARATE FORM (NOT DISPOSE AS COMMON TRASH)
	DATE OF MANUFACTURE
	IDENTIFICATION OF MANUFACTURER
	GAS INLET (AR / O ₂)
	TURN ON
	TURN OFF
	ALTERNATING CURRENT
	DIRECT CURRENT

Symbols	Description
	INPUT DC - EXTERNAL POWER SUPPLY
	FUISIBLE
	US federal law restricts this device to sale by or on the order of a physician.

15.2 Symbols used on packaging and labeling

Table 4027 – Symbols used on packaging and labeling

Symbol	Description
	FRAGILE
	STEERING FACE PACKAGE TOP
	KEEP PROTECTED FROM SUNLIGHT
	KEEP PROTECTED FROM MOISTURE
	MAXIMUM STACKING
	TEMPERATURE LIMITS
	CONFORMITY CE: INDICATES THAT THE SYSTEM IS IN ACCORDANCE WITH DIRECTIVE OF THE EUROPEAN COUNCIL 93/42 / EEC FOR MEDICAL EQUIPMENT
	INMETRO
	USE BY DATE
	NON-STERILE
	DO NOT USE IF PACKAGE IS DAMAGED
	MANUFACTURER'S CATALOGUE NUMBER

Symbol	Description
 The symbol consists of the letters 'SN' in a bold, black, sans-serif font, enclosed within a square border.	MANUFACTURER'S SERIAL NUMBER
 The symbol consists of the letters 'LOT' in a bold, black, sans-serif font, enclosed within a square border.	MANUFACTURER'S MATCH OR LOT CODE
 The symbol is a blue circular icon with a white silhouette of a person reading a book.	THE INSTRUCTION MANUAL MUST BE READ
 The symbol is a black circular icon with a white number '2' inside, and a diagonal slash through it, indicating a single use.	SINGLE USE

16 Abbreviations and used Terms

Table 41 - Abbreviations and used terms

Abbreviations	Meaning
ΔPS	Support pressure (above PEEP)
O ₂	O ₂ Concentration
PEEP	Positive end-expiratory pressure
Pr Control	Controlled Pressure (above PEEP)
Pr Inferior	Lower-level pressure
Pr Insp	Inspiratory Pressure (absolute)
Pr Limit	Pressure Limit
Pr Higher	Higher-level pressure
Sensib Fl	Flow sensitivity
Sensib Pr	Pressure sensitivity
T lower	Lower level time
T Rise	Rise Time
T Higher	Higher level time
Time Ins	Inspiratory Time
Vol Minute	Minute Volume
Vol/Weight	Weight Volume
NIV or VNI	Noninvasive Ventilation
O ₂ +	O ₂ Concentration 50% to 100% de O ₂
O ₂ 100%	100% O ₂ Concentration for a time
MANUAL CYCLE or MANUAL INSP	Manual cycle shooting
HOLD INSP	Inspiratory Pause
HOLD EXP	Expiratory Pause
Leakage	Percentage or leakage flow
Cdyn	Dynamic Compliance
Cstat	Static Compliance
E	Elastance
R Rate or f	Respiratory frequency
Rate sp or fspont	spontaneous respiratory rate
I:E	I:E Ration
Pmean	Medium preassure
Ppeak	Preassure peak
Pplat	Preassure plateau
RE	Expiratory resistance
RI	Inspiratory resistance
RSBi	Rapid Shallow Breathing Index

Abbreviations	Meaning
TC	Expiratory Time Constant
Te	Expiratory Time
Ti	Inspiratory Time
Ti/Ttot	Reason inspiratory time to total time
Vte or VTE	Total volume expired
Vte sp or VTE spont	Total volume expired spontaneous
Vti or VTI	Total volume inhaled
MV or VM	Minute volume
MV sp or VM spont	Minute volume spontaneous
WOBi	Imposed Work Of Breathing



WARNING

- *The controlled pressure adjustment (Pr Control) in adult or pediatric patients, refers to a gauge pressure, that is, sets the pressure value above PEEP.*
- *The resulting inspiratory pressure is the sum of the pressure controlled with PEEP.*

17 Biocompatibility Declaration

We declare, under our sole responsibility, that all materials used in parts (as defined in standard NBR IEC 60601-1) of the Fleximag's family have been widely used in the medical field over time, thus ensuring their biocompatibility.

According to ISO-10993-1 Standard Biological evaluation of medical devices — Part 1: Evaluation and testing – clause 5 – the ventilator, its parts and accessories are classified as a device without direct or indirect contact with the patient's body. Therefore, the ventilator, its parts, and accessories are not included in this standard's scope.



WARNING

- ***The common accessories acquired from third parties MUST comply with local legislation.***
-

18 Guarantee

Manufactured and commercialized products by **MAGNAMED TECNOLOGIA MÉDICA S/A.** are guaranteed against material defects and manufacturing throughout Brazilian territory according to the dispositions below.

The guarantee period of the equipment is 12 months. For the batteries and accessories, the period of 3 months, since kept its original features, terms such as from the date acquisition by the first purchaser of the product, on the Fiscal Sales note MAGNAMED TECNOLOGIA MÉDICA S/A.

The guarantee responsibility is limited to substitution, repair, and hand labor regarding the parts that present defects or that do not attend to the specifications contained in the Product's Operation Manual.

The guarantee is limited to the product that is used under normal conditions and for its intended use, and which preventive maintenances and part substitutions, and repair are realized according to the instructions stated in the Product's Operation Manual by the manufacturer's authorized personnel.

The guarantee does not cover damages caused by the inadequate use or installations, accidents, inadequate sterilization, service, installation, operation, or alteration realized by non-authorized personnel.

The disruption or absence of seals or guarantee stamps by non-authorized personnel results in the product's guarantee loss.

The parts that are subject to normal use of wear and tear, adverse use conditions, undue use, or accidents that are not covered by guarantee.

Eventual expenses and risks with product transportation are not covered by the guarantee.

For equipment sold with extended guarantee, it will only be valid if the preventive maintenance suggested by MAGNAMED are carried out in accordance with Chapter 9 of this manual

There is no expressed or implicit guarantee, besides those exposed above.

19 Technical Assistance

For maintenance please contact our technical assistance that will indicate the service closest to you or consult our website.

20 Training

To request training, contact Magnamed Product Specialist who will direct you to the nearest authorized representative.

This product is exclusively intended for use in lung ventilation and must only be operated by qualified professionals.

MAGNAMED

**Manufacturer
Technical Assistance
Customer Service**



Rua Santa Mônica, 801, 831
06715-865 – Parque Industrial San José - Cotia – SP Brasil
Tel/Fax: +55 11 4615-8500
E-mail: magnamed@magnamed.com.br
Website: www.magnamed.com.br
CNPJ: 01.298.443/0002-54
State Inscription: 149.579.528.111

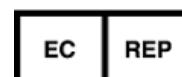

European Representative
CMC Medical Devices & Drugs S.L.
Horacio Lengo Nº 18, CP 29.006
Málaga – Spain
Phone: +34 951214054
Fax: +34 952330100
E-mail: info@cmcmedicaldevices.com
Website: www.cmcmedicaldevices.com

Technical Responsible: Toru Miyagi Kinjo
Inscription CREA-SP 5061555031
Legal Responsible: Wataru Ueda